



BATHROOM CATALOGUE 2021

Ceramic colours

Glossy colours



01 White Alpine



T2 White Alpine AntiBac CeramicPlus



R3 Pergamon CeramicPlus

R1 White Alpine CeramicPlus

ViClean-100



S0 Glossy Black CeramicPlus

Matt colours



RW Stone White CeramicPlus TitanGlaze



S5 Ebony CeramicPlus TitanGlaze



i4 Graphite CeramicPlus TitanGlaze



AM Almond CeramicPlus TitanGlaze

Bicolour



BCW0 Fog



BCW2 Ocean



BCW8 Rust



BCW9 Indian Summer



BCT0 Powder



BCT7 French Linen



BCT8 Coal Black



BCS8 Sage Green



BCS9 Bordeaux

Cap colours



96 Star White



J5 Curaçao



LK Bali



LL Peru



LM Sahara



LQ Florida

Metal surfaces













61 Chrome-plated



66 Brass





















Symbols

-  suitable for 3-hole tap fittings, central tap hole punched out
-  suitable for two 3-hole tap fittings, central tap holes punched out
-  suitable for 3-hole tap fittings, 3 tap holes punched out
-  suitable for 1-hole tap fittings, tap hole punched out
-  suitable for two 1-hole tap fittings, tap holes punched out
-  without tap hole (pre-punched tap holes)







-  with overflow
-  with concealed overflow
-  without overflow (unclosable outlet valve must be used with models without overflow)
-  suitable for 1-hole tap fittings, tap hole punched out on left, tap hole on right pre-punched
-  suitable for 1-hole tap fittings, tap hole punched out on right, tap hole on left pre-punched

Icons





Bath ceramic

-  Anti-bacterial ceramics
-  Titan ceramic
-  Invisible fastening for trap covers
-  Invisible fastening for wall-mounted WC
-  Invisible fastening for wall-mounted WC compact
-  ViClean shower toilet
-  ViClean remote control
-  ViConnect WC-element
-  ViFresh Technology for WCs
-  ViFlow Overflow system
-  WC complete
-  WC rimless
-  Toilet: efficient flushing technology
-  Toilet seat and cover SlimSeat
-  WC: Vario drainbend
-  WC: Vario drainbend
-  WC: Vario drainbend
-  WC with water-saving system AQUAREDUCT: flush volume: 3 / 4,5 litres
-  Urinals: Prodetect 2, radar flush control
-  Urinals: flush volume 1,0 litres
-  Adjustable flush flow control















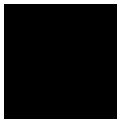





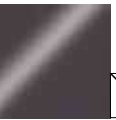









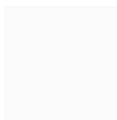
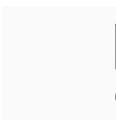











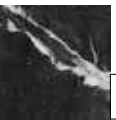

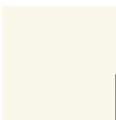
Bathroom furniture

-  These products are always in stock.
-  Mirror with sound system
-  Bluetooth
-  Vanity unit: height 520 mm
-  Vanity unit: height 590 mm
-  Smart lighting control

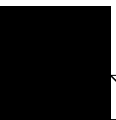
Wellness

-  Whirlpool Systems technical part: accessible via
-  Whirlpool Systems technical part: Control box
-  Whirlpool Systems technical part: Rim control
-  Material: Quaryl®

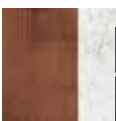
Furniture colours

 Front Colour		 Body Colour		 Colour of cover plate / countertop		 Inside colour of Finion shelf	
1 = Glass White Matt	2 = Glass Black Matt	B1 = Crystal Grey	B3 = Crystal Black	B4 = Crystal White	DH = Glossy White	E8 = White Wood	FP = Glossy Grey
							
FINION	FINION	AVENTO	AVENTO	AVENTO	COLLARO LEGATO SUBWAY 2.0 VENTICELLO	COLLARO LEGATO SUBWAY 2.0 VENTICELLO	COLLARO LEGATO SUBWAY 2.0 VENTICELLO
GF = Glossy White Lacquer	GJ = Light Grey Matt Lacquer	GK = Anthracite Matt Lacquer	GM = Olive Matt Lacquer	GN = Walnut Veneer	HB = Peony Matt Lacquer	HF = Gold Matt Lacquer	HG = Midnight Blue Matt Lacquer
							
FINION	FINION	FINION	FINION	FINION	FINION	FINION	FINION
HH = Sand Matt Lacquer	MS = White Matt	MT = White Matt Lacquer	PC = Oak Veneer	PD = Black Matt Lacquer	PH = Glossy Black Lacquer	PN = Elm Impresso	PV = American Walnut
							
FINION	COLLARO LEGATO SUBWAY 2.0 VENTICELLO	FINION	FINION	COLLARO FINION LEGATO SUBWAY 2.0 VENTICELLO	FINION	AVENTO LEGATO SUBWAY 2.0 VENTICELLO	ANTHEUS
PW = Black Ash	R = Glass Silver Grey	RA = Glass Glossy Grey	RC = Carrara	RE = Glass Glossy White	RH = Kansas Oak	RK = Stone Oak	RP = Nero Marquina
							
ANTHEUS	SUBWAY 2.0	VENTICELLO	ANTHEUS	VENTICELLO	AVENTO COLLARO LEGATO SUBWAY 3.0 VENTICELLO	AVENTO COLLARO LEGATO SUBWAY 3.0 VENTICELLO	ANTHEUS
S = Glass White	VE = Brilliant White	VF = Pure White	VG = Truffle Grey	VH = Arizona Oak	VJ = Nordic Oak	VK = Soft Grey	VL = Volcano Black
							
SUBWAY 2.0	SUBWAY 3.0	SUBWAY 3.0	COLLARO LEGATO SUBWAY 2.0 VENTICELLO	AVENTO COLLARO LEGATO SUBWAY 2.0 VENTICELLO	AVENTO COLLARO LEGATO SUBWAY 2.0 VENTICELLO	COLLARO LEGATO SUBWAY 2.0 VENTICELLO	SUBWAY 3.0
VM = Taupe	VN = Cashmere Grey	VQ = Marine Blue	VR = Graphite	Walnut/Grey-White Marble	White Matt Lacquer/Black Marble		
							
SUBWAY 3.0	SUBWAY 3.0	SUBWAY 3.0	SUBWAY 3.0	HOMMAGE	HOMMAGE		

INDEX

INSTRUCTION

Sanitaryware & Bathroom Furniture	2
Wellness	2

GENERAL INFORMATION

General Sales Conditions	4-5
Bicolour	9
TwistFlush	10
Hygiene Champion	11
Icons	see fold-out cover
Symbols	see fold-out cover
SupraFix 3.0	12
Important note	3

OVERVIEWS

AntiBac	13
Express Delivery	14
Ceramic colour survey	6-7
Colour survey - Wellness	8

SANITARYWARE & BATHROOM FURNITURE	19
-----------------------------------	----

SHOWERS	321
---------	-----

BATHS & WHIRLPOOL SYSTEMS	377
---------------------------	-----

HOW TO USE THIS PRICE LIST

General

This price list begins with a table of contents, which gives an overview of the structure of the entire price list.

The price list consists of the following areas:

- General section
- Sanitaryware & Bathroom Furniture
- Showers
- Baths & Whirlpool Systems

The general section contains comprehensive information on various topics such as changes to the range, general terms and conditions of sale, etc. You will find all the subject areas covered in the "General" section of the table of contents.

The sections "Bathroom ceramics & bathroom furniture", "Showers" and "Baths & whirlpool systems" are all structured in the same way: They begin with a table of contents, which gives an overview of the contents of the respective area. The various products are then presented and these are followed by a list of all the collections.

You will find the index right at the back of the price list.

Product section - Bathroom ceramics & bathroom furniture

The different collections are listed in alphabetical order.

On the first page of each collection, you will find comprehensive information for the entire collection, such as the available colours.

Please note that not all colours are always available for each model. You will find the colour combinations available on the respective product pages.

Within the collections, the individual products are listed in the following order: washbasins, hand-rinse washbasins, bidets, toilets, urinals, furniture.

In the matrix beneath the chosen article, you will find product-specific information, such as the article number, price, colour, design, etc., as well as matching accessories.

Please note that the toilet seats & covers are made from solid-coloured Duroplast and are not available in CeramicPlus.

You will find the respective colour codes for the products in the footnote. Please insert a colour code (e.g. R1) for all the variables in the article number (e.g. "XX") to order the article you require.

A decorated version of some articles is available (see comment "1" after the article number).

The surcharges for the décors can also be found in the footnote, where the respective surcharge is given, as well as the colour (price) on which the surcharge is to be added.

Product section - Wellness

The Wellness product section is divided into the following areas:

- Showers (ceramic, Quartz and acrylic)
- Baths & Whirlpool Systems

The different collections are listed in alphabetical order.

The colour codes for the products are to be found in the overview of colours and models or on the separating sheet. When ordering, please always replace the variable "XX" at the end of the article number with the colour code required.

Some shower trays can be ordered with VILBOgrip, which prevents slipping on smooth surfaces such as acrylic. The corresponding order number can be found with the respective product.

Use the the fold-out pages on the right-hand side to order installation systems, accessories, panels etc. for baths with or without whirlpool systems.

Various free-standing bathtubs can be ordered in bicolour look. Further information and the corresponding order form can be found on the respective product pages and behind the bathtub chapter.

With the help of the right fold-out pages you can order installation systems, accessories, panels etc. for bathtubs with or without whirlpool system.

IMPORTANT NOTE

Sanitaryware & Bathroom Furniture

Price list 2021 replaces all earlier price lists. It applies to all deliveries as of April 1st, 2021.

Shades and dimensions subject to the usual tolerances. We reserve the right to make technical modifications to the range and alter colours.

This document may only be reproduced or copied in full or in part in any form with the producer's permission.

Price information

The prices shown are accounting prices exclusive of VAT which apply for sanitaryware wholesalers as of April 2021. The accounting prices provide the basis for the individual accounting terms agreed with the customer.

They do not represent the manufacturer's recommended retail price (RRP), which may differ from the accounting price.

We reserve the right to make (price) changes; prices are subject to printing errors. Claims arising from incorrect prices and descriptions shall not be considered.

All offers, sales and deliveries of sanitaryware, bathroom furniture as well as accessories are subject to our "General Sales Conditions"

**The prices of all washbasin models and bidets only cover the ceramics.
The tap fittings and soap dispensers shown are not included in these prices.**

The prices of furniture / furniture elements do not include the ceramics.

Sanitaryware

The ceramic materials used by Villeroy & Boch are very robust. They are capable of withstanding all temperature strain caused by hot or cold water or steam.

The glazed surfaces of Villeroy & Boch's sanitary ceramics are scratch-resistant and able to

withstand all soap-water solutions and acids generally arising in the sanitary area. This does not include hydrofluoric acid or compounds. Nor is the surface affected by organic solvents and intensive agents.

The symbols for the tap hole and overflow are explained on the fold-out cover page.

Furniture

The bathroom furniture programmes from Villeroy & Boch feature high-quality materials and craftsmanship. Our own production facilities in Germany and Austria guarantee a uniform high quality. Furniture may only be assembled by a qualified professional in accordance with the assembly instructions enclosed and using the attachment materials supplied.

Further information, such as 2D/3D data or brochures, is available to download from the company website.



These products are always in stock

Produced to order: Please note that it is not always possible to cancel or alter orders!

Warranty

The statutory warranty period applies for all Villeroy & Boch products:

- Bathroom ceramics 2 or 5 years
- Bathroom furniture 2 years
- ViConnect and ViClean 2 years
- Toilet seats, accessories and tap fittings 2 years

Further technical information is to be found at www.villeroy-boch.com

Wellness

General

All Villeroy & Boch baths and shower trays are manufactured from top quality bathroom acrylic reinforced with glass fibre, or from the unique Quaryl®. Quaryl® is a synthetic material developed by Villeroy & Boch which is cast in moulds, therefore very exact designs can be produced. The synthetic material is coloured all the way through and retains its colour and shine for many years.

Design

Acrylic and, in particular, Quaryl® can be formed into all sorts of shapes very easily so that innumerable bathroom designs are possible. There is a suitable bath for all bathrooms: rectangular, hexagonal, oval or corner bath. From modern and minimalistic to royal and comfortable with handgrips and headrests. You will always feel at home in a Villeroy & Boch bath.

Temperature take-up

The material, be it acrylic or Quaryl®, takes on the temperature of the bath water almost immediately. This has the big advantage that you will not receive a cold shock when you lie down in the bath or step into the shower.

Heat insulation

Acrylic and Quaryl® conduct heat slowly. Therefore the heat from the bath water is retained longer. This insulating capacity has the added advantage that the bath does not have to be continually topped up with hot water.

Maintenance

The surfaces of acrylic and Quaryl® have no pores so they repel bacteria. Dirt, limescale and soap residue are virtually unable to gain a hold on the material, so that maintenance is restricted to wiping down with a wet cloth or sponge and the use of a non-scouring cleanser. We advise you to rinse out the whirlpool systems once a month with washing soda, particularly if bath oils are used. Our shower cabins are best cleaned using liquid soap.

Safety & hygiene

Villeroy & Boch whirlpools meet the highest standards of safety and hygiene. To assure hygiene, some models are equipped with special jets or have a fully automatic cleaning system, which automatically engages when the bathwater has drained. The pipes are then dried by air. The blowing-dry can also be performed manually, for example, if water has entered the system while the bathtub is being cleaned. To guarantee safe operation, all water-carrying whirlpools are equipped with a special hair trap, which stops water suction if the drain is blocked. To prevent the whirlpool from being switched on when there is no water in the tub, all systems feature dry-run protection that operates by means of a level sensor. The Whisper systems carry the KEMA test mark and of course the CE logo as well.

Cleaning and hygiene

Villeroy & Boch whirlpools are very easy to clean. After use, the bathtub should be rinsed with

clean water and dried with a cloth. All jets can be disassembled at any time for cleaning, using the equipment provided. We recommend mild detergents that will gently clean the surface of the jets. It is highly recommended not to use bath products containing oil, but bath salts, etc. can safely be used, as long as the salt dissipates. To achieve optimal hygiene in the pipes, we recommend rinsing the whirlpool once a month with a cleaner.

Material

Acrylic and Quaryl® are very durable materials which, when correctly maintained, keep their colour and shine for many years. Quaryl® is partly composed of natural materials. One of the characteristics of Quaryl® is that, in exceptional cases, small irregularities may appear in its structure. Scratches in acrylic materials are seldom. Naturally light damage or burn marks can occur, but these can be very easily removed from acrylic by using fine sandpaper (no. 1000 to 1200) and a small piece of fine steel wool. After this shining colour surfaces must be further treated with a car polish compound to reproduce the original lustre. It is also possible to repair damage to Quaryl®. We advise you to contact our professional service department if any of your Quaryl® product become damaged.

Warranty

The statutory warranty period applies for all Villeroy & Boch products:

- Baths, shower trays made from acrylic and Quaryl® 5 years
- Whirlpool systems and technical components 2 years
- Accessories and tap fittings 2 years

In addition, we offer a 10-year guarantee on all baths and shower trays made from acrylic or Quaryl® in accordance with the relevant warranty conditions.

Price information

* The prices shown are accounting prices exclusive of VAT which apply for sanitaryware wholesalers as of April 2021. The accounting prices provide the basis for the individual accounting terms agreed with the customer.

They do not represent the manufacturer's recommended retail price (RRP), which may differ from the accounting price.

• We reserve the right to make (price) changes and to correct printing/typing errors.

No rights can be derived from errors made in prices and descriptions.

• All prices excl. VAT.

GENERAL SALES CONDITIONS OF VILLEROY & BOCH AG

Bath and Wellness Division - Rev. August 2016

I. General

- These General Conditions of Sale (hereinafter referred to as "conditions of sale") shall apply to all – i. e. also to future – quotations, supply and other performance by Villeroy & Boch AG including all its branches and group companies (hereinafter referred to as "we", "us" or "ourselves"), to customers who are not consumers within the meaning of § 13 of the German Civil Code BGB (hereinafter referred to as "purchasers"; the purchaser and ourselves taken together also being referred to hereinafter as "the parties").
- These conditions of sale shall, unless any other provision is expressly made, apply for the entire duration of the business relationship without its being necessary for us to make specific reference to the fact. Business conditions of the purchaser shall not apply unless expressly recognised by ourselves in writing. These conditions of sale shall also apply if we make deliveries to the purchaser unconditionally while aware of conditions of the purchaser which are contradictory to or deviate from our conditions of sale.
- Any alterations (amendments / additions) to these conditions shall require to be made in writing.
- Verbal collateral agreements or assurances shall be invalid unless confirmed by ourselves in writing.

II. Quotations

- Unless designated as binding in their text, our quotations shall be non binding and without obligation and shall not place us under any obligation to accept a given order.
- If, after the conclusion of the contract, modifications are called for by our customers, or if the contract is cancelled wholly or in part, all the costs and expenses and other losses thus far incurred by ourselves or to be incurred in connection therewith (e. g. lost profit) shall be chargeable to the customer. Cancellation will only be possible with our approval. This shall not affect any rights the purchaser may have to rescind or avoid the contract.

III. Prices and deliveries

- If the parties have not agreed any other price, the price shall be determined according to our price lists as valid at the time when the contract is concluded. Unless the parties have agreed anything different, the purchaser shall, in addition to all prices in accordance with the price lists, bear the costs of packaging and shipment and the turnover tax and any other public fees.
- Deliveries shall be made under the contractually agreed conditions. Unless the parties have expressly agreed anything else, deliveries shall be made ex works.
- The delivery dates or periods stated in the order confirmation shall be estimated dates or periods and shall therefore be non binding. They shall only be binding if confirmed as such in the order confirmation.
- Unless any other contractual agreement has been made, the delivery period shall begin on receipt of written confirmation of the order.
- A delivery period or date shall be deemed to have been met if the goods leave our works or warehouse or, as the case may be – if they are to be collected by the purchaser – are ready for collection prior to expiry of said date or period.
- If a non-binding delivery date or period (referred to here below in Section 6 as "non-binding delivery period") is not met, we shall be deemed to have defaulted thereon when a grace period has expired and a reminder been received from the purchaser, unless we can prove that we were not responsible for our failure to meet the non-binding delivery period or effect delivery during the grace period.

The length of the grace period shall be 1/5 of the non-binding delivery period. The grace period shall begin on the first

working day that follows the end of the delivery period. If the length of the grace period is not an exact number of full days, weeks or months, it shall be rounded off to the nearest full number of days (example: non-binding delivery period 27 days, 1/5 = 5.4 days, grace period = rounded off to 5 days).

The non-binding delivery period shall be calculated in accordance with Section III. 4.

- If a delivery period or date is not met for reasons for which we are not responsible, in particular in cases in which we ourselves have received a late or incorrect self-delivery or deliveries, the delivery period shall be extended by a reasonable period.

If we are, furthermore, unable to render our performance within said reasonably extended delivery period for reasons for which we are not responsible, we shall inform the purchaser of the fact without delay. In such cases we shall have the right to rescind the contract within a period of two weeks beginning from the moment when we inform the purchaser. Having exercised said right of rescission we shall reimburse the purchaser without delay for any counter-performance that he may already have rendered.

For the rest, the statutory rights and entitlements of the parties shall remain unaffected.

IV. Packaging

- Unless any special packaging has been agreed, the goods shall be packaged at our discretion in accordance with the standard commercial methods.
- The costs of transport packaging (e. g. euro containers, cardboard boxes or crates) shall be invoiced to the purchaser. If goods are shipped in reusable containers a rental charge or circulation fee will be invoiced. The reusable containers are to be returned immediately to the pool via the return shipment logistics system. Costs incurred by non-fulfilment of this obligation shall be invoiced to the customer. Packaging units will be taken back within the framework of and as governed by the respective statutory regulations.
- Loading costs are to be borne by the purchaser as shipment costs. If goods are loaded on pooling pallets, we shall accompany the loading procedure at the roadside in direct pallet exchange with the haulage contractor. If haulage contractors or customer's vehicles are used, the purchaser must supply intact exchange pallets. Missing pallets will be invoiced to the purchaser.

V. Shipment

- Goods will be shipped at the expense and risk of the purchaser.
- The risk shall pass over to the purchaser when the articles to be delivered are handed over to the transport company or to the purchaser himself.
- Insurance shall only be taken out at the wish and expense of the purchaser.
- Transport damage is to be reported to the haulier for inspection without delay. The purchaser must ensure that the complaint is noted in the shipment record. The shipment record provided for such cases is to be sent to us without its being necessary for us to request that it be sent.

VI. Terms of payment

- Unless any other agreement has been made, our claims shall fall due for payment in full as soon as the invoice has been received. The definitive date in determining whether or not payment has been made in due time shall be the date on which payment is actually received.
- If it becomes apparent to us after conclusion of the contract that there is a risk that the orderer may not be in a position to fulfil his performance obligations, we shall have the

right to insist that outstanding deliveries be effected only against advance payment or the provision of securities. If said advance payments have not been made or securities not provided after the expiry of a reasonable period set by ourselves, we shall be entitled to rescind all or any of the contracts affected thereby or any part thereof. The period shall be regarded as reasonable if it is at least 10 calendar days, though the purchaser shall also have the option of showing that the period was not reasonable in a given individual case. We shall in particular be entitled as above if it comes to our knowledge that the purchaser has drawn cheques not covered by sufficient funds, if bills of exchange or cheques of the purchaser's are protested, if an application is made for the institution of insolvency proceedings or if insolvency proceedings are actually instituted: the above notwithstanding our entitlement to assert further rights.

- Bills of exchange and cheques will only be accepted following special agreement and in all cases only as conditional payment. Discount charges, collection fees and all other costs shall be chargeable to the purchaser.

VII. Retention of title

- We shall reserve ownership of the delivered goods until such time as all payments arising from the existing business association with the purchaser have been received; said reservation refers to the acknowledged balance.
- The purchaser shall have the right to resell goods subject to retention of title in the normal course of business, but only under retention of title. The purchaser may neither pledge the goods subject to retention of title nor transfer title of them as security. The purchaser hereby now assigns to us as collateral all claims which accrue to him from the resale in the amount of the final invoice of our claim (inclusive of turnover tax). We hereby accept the assignment. The claims thus assigned to us in advance by the purchaser also relate to the acknowledged balance and, in the case of insolvency of the purchaser, to the existing causal balance. The cover limit of the assigned claims shall be 110% of the realisable value of the goods subject to retention of title sold and delivered in each respective case. The purchaser shall be empowered to collect the claim. Said empowerment to collect and authorisation to resell may be revoked by us if the purchaser is in breach of any of his material contractual obligations (e. g. default in payment).
- The purchaser shall inform us without delay of any attempts by third parties to take possession of the goods delivered under retention of title, doing so if possible at an early stage, when such attempts are still imminent. He shall inform third parties attempting (or intending to attempt) to take possession of the goods that the latter are our property. Any costs of interventions (e. g. § 771 of the German Code of Civil Procedure [ZPO]) shall be borne by the purchaser if the third party is not in a position to reimburse us for the judicial and extrajudicial costs.
- If the purchaser is in breach of any of his material contractual obligations, in particular in cases of default in payment, we shall have the right to repossess the purchase object and to visit the premises of the purchaser for the purpose of so doing. Rescission of the contract is, furthermore, imminent in any such repossession of the purchase object by us. We shall, after repossession, be authorised to exploit the purchase object commercially, whereby the proceeds from such exploitation are to be offset against the liabilities of the purchaser (e. g. damages) – minus reasonable exploitation costs. If the purchaser was culpable in his breach of the obligation that led to the rescission, he shall remit to us lump sum compensation for the return transport

GENERAL SALES CONDITIONS OF VILLEROY & BOCH AG

Bath and Wellness Division - Rev. August 2016

of the purchase object in the amount of 5% of the purchase price. This sum may be set higher or lower if we can prove that the loss or damage was in fact greater, or if the purchaser can prove that it was in fact smaller.

5. We shall, for as long as a claim on our part is outstanding, have the right to request information from the purchaser at any time as to which goods delivered under retention of title are still in his possession, where they are, and to which customers the remaining goods supplied by us have been sold, said information relating to quantity, type and number. We shall also have the right to inspect the goods delivered under retention of title on any of the purchaser's premises, wherever the goods may be at any given time.

6. The purchaser shall be under obligation to treat the purchase object with due care and to carry out any necessary servicing and maintenance work at his own expense, to insure our goods against fire and theft at his own expense, and to furnish us on request with proof that said insurance has been taken out.

7. a) Any processing or remodelling of the purchase object by the purchaser will always be carried out on our behalf. If the purchase object is processed with other objects of which we are not the owner, we shall acquire co-ownership of the new thing in proportion of the value of the purchase object (final invoice amount inclusive of turnover tax) to the other processed objects at the time of processing. For the rest, the provisions governing retention of title shall apply correspondingly to the thing created by the processing.

b) As security against our claims against him, the purchaser shall also assign to us the claims which accrue to him against a third party as a result of his combining the purchase object with a plot of land.

8. If the purchaser can prove that the realisable value of the securities exceeds that of the outstanding claims by more than 10%, we shall release the surplus amount if requested to do so by the purchaser.

VIII. Product characteristics

1. We hereby draw attention to the following: On account of differing materials and manufacturing procedures, a series may feature variations in colour, often also depending on the lighting conditions.

For typographic reasons there may be deviations in colour between the illustrations in a prospectus / catalogue and the actual product itself.

Acidic and / or caustic cleansing agents may cause damage if improperly used.

Goods labelled „seconds“ will be inferior in design and quality to goods labelled „1st choice“.

2. We reserve the right to produce goods with variations in finish, colour and shape such as are usual in the trade.

3. If the purchaser makes any subsequent changes to the goods supplied by us, in particular decorations or technical modifications, he shall not be permitted to resell them under our trademark unless we have issued our prior agreement to the changes in writing.

IX. Warranty

1. Unless any other provision is made here below relating to the rights of the purchaser in cases of material and legal defects, the statutory regulations shall apply. In particular, moreover, the special statutory regulations covering final delivery of the goods to a consumer (recourse claims against suppliers in accordance with §§ 478, 479 of the German Civil Code BGB) shall remain unaffected.

2. § 377 of the German Commercial Code (HGB) shall apply in respect of the inspection of the goods and notification of defects, with the proviso that the period for giving notice of obvious defects shall be two weeks as from delivery, whilst the period for giving notice of defects that are not obviously discernible shall be two weeks as from their discovery.

3. If the goods are defective, we shall at our discretion be entitled either to rectify the defects (rectification of defects) or deliver defect-free goods (replacement delivery).

4. The purchaser shall store and handle rejected goods in the correct and proper manner.

5. We shall have the right to examine rejected goods together with an expert or other third party appointed by ourselves for the purposes of appraisal, and if necessary for the purpose of drawing up cost estimates or similar. If the purchaser fails to make the rejected goods available to us for examination within a reasonable period set by ourselves, our liability for the defects shall cease on expiry of said period.

6. In the course of supplementary performance which we are liable to carry out, we shall neither be under obligation to remove the defective thing nor to install the new thing if we were not originally under obligation to install.

7. Warranty claims on the part of the purchaser such as are oriented toward damages or compensation for futile expenditure may stand as governed in Section X („Liability“), but shall otherwise be excluded.

8. For goods which have in accordance with their normal intended use been used in a building and have caused said building to be defective, the period of limitation shall be 5 years as from delivery. For all other goods the period of limitation shall be 1 year as from delivery. In cases of intent or gross negligence or if a guarantee has been given (§ 444 of the German Civil Code BGB), and cases such as those quoted in § 479 of the German Civil Code BGB and other special statutory regulations on limitation, the statutory period of limitation will continue to apply.

9. Our liability for defects shall not extend to cover damage caused by normal wear and tear (e. g. metal abrasion or wear caused by abrasive agents), deterioration in surface properties such as was unavoidable according to the accepted engineering standards at the time when the contract was concluded, improper use of the goods, non-compliance with the instructions for cleaning, care or use, or damage caused by the purchaser or a third party or parties.

X. Liability

1. We shall be liable to the purchaser for damages and compensation for expenses, in each case as governed by the statutory regulations, in the following cases (here below in Section X: „Liability“): liability under the German Product Liability Act (ProdHaftG); intent or fraudulent misrepresentation; gross negligence; injury to life, limb or health; cases in which a guarantee has been given by ourselves; cases such as those quoted in § 288 Para. 6 Sentence 1 of the German Civil Code BGB and any other cases of statutory compulsory liability.

2. We shall also be liable to the purchaser for damages in case of culpable breach of material contractual obligations as governed by the statutory regulations. Material contractual obligations within the meaning of this clause are all obligations the breach of which jeopardises the achievement of the object of the contract and all obligations without the performance of which the contract cannot properly be fulfilled and in compliance with which the purchaser may routinely trust. Having said that, if a material contractual obligation is breached in a way that involves only ordinary negligence, entitlements of the purchaser to claim for damages shall, as regards the amount, be restricted to typical foreseeable loss or damage.

3. If we default on or fall behind with our performance, the purchaser shall be entitled to claim against us on the basis of that default if his claim is for a contractual penalty or lump-sum compensation incurred within a supply chain in another contractual relationship in that supply chain, but only if he informed us expressly about the risk of such loss or damage prior to the conclusion of the contract. If not, the purchaser shall be entitled to claim for a contractual pen-

alty or lump-sum compensation owed and paid by him as loss or damage caused by default only in the amount of a maximum of 5% of the net value of our order. The above shall apply correspondingly if the purchaser makes a claim against us for indemnification in respect of such contractual penalties or lump-sum compensation.

4. For the rest, there shall be no entitlement of the purchaser to claim for damages for whatever cause in law.

5. If our liability is restricted or excluded in accordance with the above provisions, the same shall apply to the personal liability of our legal representatives, employees, non-managerial staff and vicarious agents.

6. The entitlement of the customer to claim for damages shall fall under the statute of limitation within the statutory periods of limitation, the statutory regulations also applying as regards the beginning of said periods.

XI. Offset, right of retention

1. The purchaser shall only be entitled to offset against due claims which are uncontested or have been established as legally established as final.

2. The purchaser shall only be entitled to a right of retention in respect of legally enforceable or uncontested claims.

XII. Industrial property rights

All industrial and intellectual property rights relating to our products, shapes, illustrations, installation instructions, reports, data and other records and documents shall remain the property of ourselves or, as the case may be, our respective licensors. No rights of use or exploitation shall be granted to the purchaser relating to said industrial or intellectual property rights.

XIII. Applicability of German law, place of jurisdiction

1. The law of the Federal Republic of Germany shall apply, there being no recourse to the UN Convention on Contracts for the International Sale of Goods (CISG).

2. If the purchaser is a businessman who concludes the contract in the context of a commercial transaction, a legal entity under public law or a separate asset under public law, the place of jurisdiction for all disputes arising from or in connection with the contract shall be the registered office of the Villeroy & Boch group company which concluded the contract. If that company does not have a general jurisdiction venue in the Federal Republic of Germany, the place of jurisdiction shall be the registered office of Villeroy & Boch AG.

COLOUR SURVEY - SANITARYWARE

COLOURS

Collections / Models	Ceramic colours														Metal part finishes	
	White Alpin	White Alpin CeramicPlus	White Alpin AntiBac CeramicPlus	Pergamon CeramicPlus	Stone White CeramicPlus TitanGlaze	Ebony CeramicPlus TitanGlaze	Graphite CeramicPlus TitanGlaze	Almond	Bicolour	White Alpin Anti-slip	Taupe Anti-slip	Ardoise Anti-slip	VIPrint	Chrome	Noble brass	
	01	R1	T2	R3	RW	S5	I4	AM	BC	01	TP	W9	VP			
ANTHEUS		○			○									○		
ARCHITECTURA	○	○	*											○		
ARTIS	○	○			○				○							
AVENTO	○	○			○									○		
COLLARO	○	○			○											
EVANA	○	○														
FINION		○			○											
HOMMAGE		○												○	○	
LIFETIME PLUS Shower trays										○	○	○				
LOOP & FRIENDS	○	○				○	○	○								
LUNEA	○															
MEMENTO 2.0	○	○			○	○	○									
MEMENTO	○	○														
MY NATURE		○														
SUBWAY 3.0	○	○	*		○									○		
SUBWAY 2.0	○	○	*	*	*	*	*							○		
SUBWAY	○	○			*									○		
SUBWAY INFINITY Shower trays										○	○	○	○			
TUBE	○															
VENTICELLO	○	○			*	*	*							○		

* Only selected models are available in this colour. Please see the product specifications pages for all the details.

COLOUR SURVEY - SANITARYWARE

Collections / Models	Discontinued ceramic colours
 <p>10 year availability guarantee on a selected range of colours and ceramic products</p>	<p>Manhattan CeramicPlus</p>
	<p>R5</p>
<p>EVANA</p>	<p>○</p>
<p>SUBWAY</p>	<p>○</p>

COLOURS

BICOLOUR - SANITARYWARE



Titan
Ceram
Villeroy & Boch

BICOLOUR

Artis – Colour in its most attractive guise.

Four forms, nine colours, thousands of possibilities: Artis comes in a broad range of colours to cover all tastes, from bold statements to subtle highlights in the bathroom. The striking surface-mounted washbasins are always an eye-catcher. The attractive BiColour look can be combined with the Finion and Legato furniture to create a colour concept for the entire bathroom.

- **4 forms:** round, oval, square and rectangular with extremely thin walls made from high-strength TitanCeram
- **BiColour look:** the coloured glaze on the outer surface meets the White Alpin of the interior at the fine rim
- **9 modern BiColour shades**

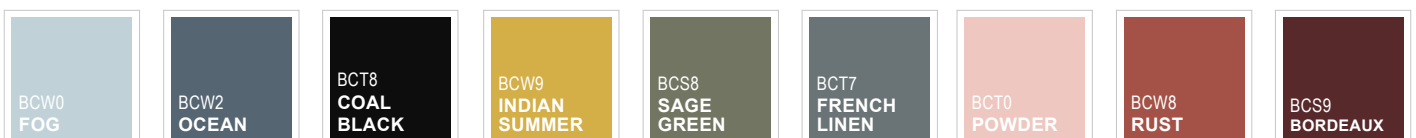

TWISTFLUSH - MORE POWER, LESS WATER

TWISTFLUSH



TwistFlush is the new toilet flushing system which ensures optimum flushing and is highly water-efficient into the bargain. It exploits the physical power of swirling water for hygienic flushing and clean results.



Flushes like no other

The TwistFlush technology (patent pending) clearly surpasses the standard requirements*. A controlled flow of swirling water generates a very powerful vortex in the conically shaped basin which flushes virtually the entire inner surface of the toilet, effectively removing soiling.



Save up to 19,700 litres of water a year

With TwistFlush, you save precious water every time you press the flush button. The toilet uses only 4.5 litres for a large flush, and a mere 3 litres for a small flush. And the flush is so powerful that you usually only need to flush once. This means that a family can save up to 19,700** litres a year.



The brushless future starts here

The conically shaped bowl with very steep and ultra-smooth walls largely avoids soiling from the outset. The powerful flushing action deals with the rest. And the toilet brush is history.



Tough on dirt and germs

In addition to its flushing power, TwistFlush also boasts hygiene benefits: the rimless bowl and CeramicPlus provide for easy cleaning, while AntiBac prevents 99.9 % of bacterial growth. In this way, the toilet reduces the spread of germs, protecting young and old alike.



Practically splash-free

With TwistFlush, every drop of water is used for flushing, with no splashing over the toilet rim*. The controlled swirling action means that the flushing power is generated just where it is needed. The water swirls over almost the entire inner surface area. There is virtually no splashing and aerosols are reduced.



Whisper-quiet flushing

TwistFlush proves that powerful flushing doesn't have to be loud. The manner in which the water flows into the toilet bowl with a swirling motion results in less noise than with conventional toilets. So no waking the family or neighbours.

* In accordance with European standard EN 997.

**4-person household, compared with a conventional 6-litre flush. Average use: 5 x per person per day, based on information from the German Federal Environmental Agency.

HYGIENE CHAMPION - SANITARYWARE

HYGIENE CHAMPION



Our hygiene champion
The innovative toilet for four times the cleanliness

Hygienic, fresh, anti-bacterial and easy to clean – with our hygiene champion, you are always in safe hands. The rimless DirectFlush Subway 2.0 toilet with innovative ViFresh technology and CeramicPlus and AntiBac finish is the perfect hygiene solution from Villeroy & Boch. The best thing about it is that you can even save plenty of water and cleaning agents. It just doesn't get safer than four-fold hygiene. ViFresh, CeramicPlus and AntiBac are available separately for DirectFlush toilets and can also be combined on request

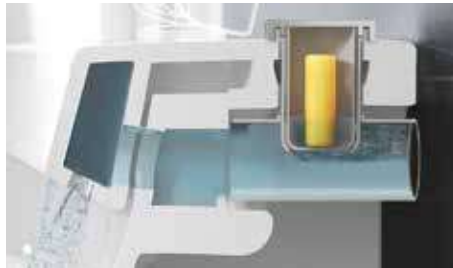

ViFresh
The integrated holder

The innovative holder for rim-blocks is integrated almost invisibly in the ceramic. It is filled without having to touch unhygienic areas and combines a fresh scent with an optimum flushing performance. As the water flow is no longer hindered by commercial holders, ViFresh is ideal for rimless toilets.

- The user-friendly solution for DirectFlush toilets
- Integrated care-product compartment within the water inlet in the ceramic
- Can be filled hygienically with commercially available rim-blocks or gel-cleaners without having to touch the toilet bowl or rim
- During flushing, the active ingredients are distributed evenly throughout the bowl
- With the same excellent flushing performance
- Simple installation without additional costs
- No bonding, no risk of corrosion

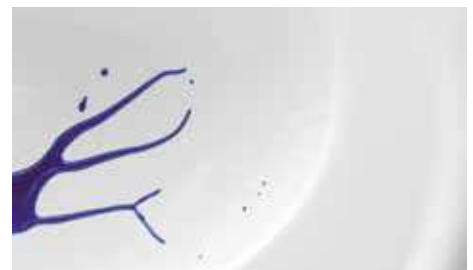
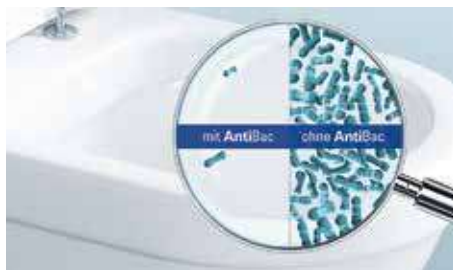

DirectFlush
The rimless generation of toilets

- Flushes the entire inner bowl without splashing
- Maximum flushing performance thanks to precise water flow
- Easy, quick cleaning thanks to the rimless design
- Visible hygiene for the user, too

AntiBac
The antibacterial glaze

- Has been proven to reduce the growth of bacteria by more than 99.9%***
- For ceramic surfaces and toilet seats
- Ideal for commercial areas with strict hygiene requirements

CeramicPlus
The dirt-repellent surface finish

- Non-stick effect prevents limescale deposits
- Permanent dirt-repellent effect for a brilliant shine
- 90% less water consumption*, cleaning agent ** and cleaning time** than before
- Available for all sanitary-ceramic products and all colours

* When contaminated with dirty water, ** When removing limescale deposits compared with standard ceramics (study carried out by the wfk-Forschungsinstitut für Reinigungstechnologie), *** Confirmed by the independent BOKEN Quality Evaluation Institute, the Bundesanstalt für Materialprüfung (BAM) in Berlin, and the IZORE Centrum Infectieziekten Friesland, NL

SUPRAFIX 3.0 - SANITARYWARE

SupraFix 3.0 has a patent pending and makes the installation of wall-mounted toilets more flexible. The toilets can be installed swiftly and simply by just one person – conveniently from above and without visible attachment. Now new: The toilet seats can be positioned as required by the customer.





Simple and flexible installation

- Easy toilet installation from above by one person
- 2-in-1 installation of the toilet and toilet seat using the same holes
- Vario-nut for flexible installation and exact positioning of the seat

Perfect toilet design

- Invisible fastening: no visible screws or cover caps
- Toilet seat can be positioned individually as required

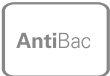
OVERVIEW ANTIBAC - SANITARYWARE

Collection	Models
ARCHITECTURA 	selected models, see pages 42-58
SUBWAY 2.0 	selected models, see pages 306-325
SUBWAY 3.0 	selected models, see pages 287-305

OVERVIEW EXPRESS DELIVERY - BATHROOM FURNITURE

Furniture Programme/Mirrors	Models	Colours Express Delivery
ANTHEUS	all models	all colours
AVENTO	all models	all colours
FINION	selected models, see pages 101-145	—
HOMMAGE	all models	all colours
MORE TO SEE	all models	—
MORE TO SEE 14	all models	—
MORE TO SEE LITE	all models	—
MORE TO SEE ONE	all models	—
MY VIEW 14	all models	—
MY VIEW 14+	all models	—
MY VIEW NOW	all models	—
MY VIEW ONE	all models	—
SUBWAY 2.0	selected models, see pages 306-325	Glossy White (DH), Glossy Grey (FP)
SUBWAY 3.0	selected models, see pages 287-305	Brilliant White (VE) and Kansas Oak (RH) in handle colour 0 (glossy aluminium), all mirrors
VENTICELLO	selected models, see pages 332-345	Glossy White (DH), Glossy Grey (FP) with handle version 1

THE VILLEROY & BOCH APP



CURRENT DELIVERY
INFORMATION AND PRICES



CONFIGURATOR BRINGS
CUSTOMERS' WISHES TO LIFE



DATA SHEETS AND
INSTALLATION INSTRUCTIONS



PRODUCT SUGGESTIONS
TO BOOST SALES



SAMPLE FOLDER CREATED
AUTOMATICALLY



OPTIONAL
OFFLINE MODE

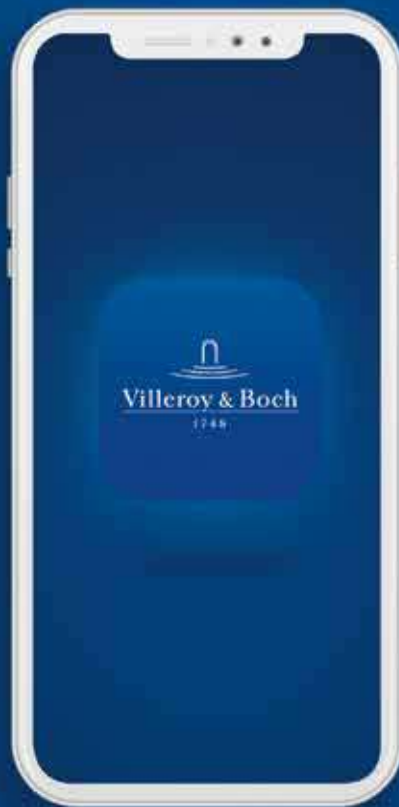

THE SMART TOOL FOR PLANNING AND CONSULTATION

Now you have the full information on Villeroy & Boch bathrooms at your fingertips. A glance at your smartphone, tablet or PC is all it takes to find current dimensions and prices while you're out and about or to configure model variants and check availability while advising customers.



For smartphone, tablet and PC.
Find out more: pro.villeroy-boch.com/villeroybochapp

SANITARYWARE & BATHROOM FURNITURE



INDEX - SANITARYWARE AND BATHROOM FURNITURE

GENERAL INFORMATION





























How to use this price list	2
Bicolour	9
Ceramic colour survey	6-7
TwistFlush	10
Hygiene Champion	11
Icons	see fold-out cover
Symbols	see fold-out cover
SupraFix 3.0	12

OVERVIEWS

Bidets	28
Urinals	29
Washbasins	20-24
Toilets	25-27

BATH CERAMIC

& BATHROOM FURNITURE

Antheus	Premium			28-35
Architectura	Profi			36-43
Artis	Premium			44-46
Avento	Mainstream			47-54
Collaro	Mainstream			55-83
Evana	Mainstream			84-85
Finion	Premium			86-130
Hommage	Premium			131-135
Legato	Mainstream			136-183
Loop & Friends	Mainstream			184-190
Memento 2.0	Premium			191-204
Stand-alone washbasins	Mainstream			233-236
Subway 3.0	Mainstream			237-255
Subway 2.0	Mainstream			256-275
Subway	Mainstream			276-279
Venticello	Mainstream			281-294
ViClean				295-299
ViConnect installation systems				300-311
WC-Seats and Cover				316-318
Accessories				312-315

MIRRORS & MIRROR CABINETS

More To See	Mainstream		205-208
More To See 14	Mainstream		209-212
More to See Lite	Mainstream		213-216
More To See One	Profi		217-218
My View 14	Mainstream		219-220
My View 14+	Mainstream		221-223
My View One	Profi		231-232
My View Now	Mainstream		224-230

WASHBASINS ACCORDING TO SHAPE AND DIMENSION

OVERVIEW

Vanity washbasin

600 mm Rectangle	600 mm Rectangle	650 mm Rectangle	800 mm Rectangle	800 mm Rectangle	800 mm Rectangle
Subway 3.0 4A70 60 (291)	Subway 3.0 4A70 6G (292)	Subway 3.0 4A70 65 (291)	Avento 4156 80 (63)	Collaro 4A33 80 (73)	Memento 2.0 4A22 80 (215)

Vanity washbasin

800 mm Rectangle	800 mm Rectangle	800 mm Rectangle	1000 mm Rectangle	1000 mm Rectangle	1000 mm Rectangle	1000 mm Rectangle
Subway 2.0 7175 80 (308)	Subway 3.0 4A70 80 (290)	Venticello 4104 8L (335)	Antheus 4A09 A2 (37)	Collaro 4A33 A5 (72)	Finion 4164 A1 (103)	Memento 2.0 4A22 A4 (213)

Vanity washbasin

1000 mm Rectangle	1000 mm Rectangle	1000 mm Rectangle	1000 mm Rectangle	1000 mm Rectangle	1200 mm Rectangle
Subway 2.0 7175 A0 (308)	Subway 3.0 4A70 A5 (290)	Venticello 4104 AK (334)	Venticello 4134 L1 (334)	Venticello 4134 R1 (334)	Avento 4A23 CK (63)

Vanity washbasin

1200 mm Rectangle	1200 mm Rectangle	1200 mm Rectangle	1300 mm Rectangle	1300 mm Rectangle	1300 mm Rectangle	1300 mm Rectangle
Collaro 4A33 C4 (71)	Finion 4164 C1 (103)	Venticello 4104 CK (333)	Collaro 4A34 D4 (71)	Subway 2.0 7175 D0 (307)	Subway 2.0 7176 D0 (307)	Subway 3.0 4A70 D4 (289)

Vanity washbasin

1300 mm Rectangle	1300 mm Rectangle	1300 mm Rectangle
Subway 3.0 4A71 D5 (289)	Subway 3.0 4A70 D5 (289)	Venticello 4111 DL (333)

WASHBASINS ACCORDING TO SHAPE AND DIMENSION

Washbasins

500 mm Rectangle



Memento

5133 50 (284)

500 mm Rectangle



Memento 2.0

4A22 50 (218)

550 mm Rectangle



Avento

4A00 55 (64)

550 mm Rectangle



Collaro

4A33 55 (76)

550 mm Rectangle



Subway 2.0

7113 55 (308)

550 mm Rectangle



Subway 3.0

4A70 55 (292)

Washbasins

600 mm Rectangle



Avento

4158 60 (63)

600 mm Rectangle



Collaro

4A33 60 (75)

600 mm Rectangle



Memento

5133 60 (284)

600 mm Rectangle



Memento 2.0

4A22 60 (217)

600 mm Rectangle



Subway 2.0

7113 60 (308)

600 mm Rectangle



Venticello

4124 60 (335)

Washbasins

650 mm Rectangle



Avento

4158 65 (63)

650 mm Rectangle



Collaro

4A33 65 (74)

650 mm Rectangle



Subway 2.0

7113 65 (308)

650 mm Rectangle



Venticello

4124 65 (335)

Surface-mounted washbasin

510 mm Oval



Collaro

4A15 51 (79)

560 mm Oval



Collaro

4A19 56 (77)

560 mm Oval



Loop & Friends

4A47 00 (201)

585 mm Oval









Loop & Friends

5151 00 (203)







WASHBASINS ACCORDING TO SHAPE AND DIMENSION

OVERVIEW







Surface-mounted washbasin

610 mm Oval	610 mm Oval	620 mm Oval	630 mm Oval	810 mm Oval	500 mm Rectangle	510 mm Rectangle
						
Artis 4198 61 (60)	My Nature 4110 60 (286)	Loop & Friends 4A48 00 (201)	Loop & Friends 5151 10 (203)	My Nature 4110 80 (286)	Memento 2.0 4A07 50 (220)	Collaro 4A17 51 (78)





Surface-mounted washbasin

550 mm Rectangle	560 mm Rectangle	560 mm Rectangle	580 mm Rectangle	585 mm Rectangle	600 mm Rectangle
					
Venticello 4113 55 (336)	Collaro 4A20 56 (77)	Loop & Friends 4A49 00 (202)	Artis 4172 58 (60)	Loop & Friends 5154 00 (204)	Finion 4143 61 (108)



Surface-mounted washbasin

600 mm Rectangle	620 mm Rectangle	650 mm Rectangle	380 mm Round	380 mm Round	400 mm Round
					
Memento 2.0 4A07 60 (220)	Loop & Friends 4A50 00 (202)	Antheus 4A10 65 (37)	Loop & Friends 4A45 00 (201)	Loop & Friends 5148 00 (203)	Collaro 4A18 40 (78)



Surface-mounted washbasin

420 mm Round	430 mm Round	430 mm Round	380 mm Square	410 mm Square
				
Loop & Friends 4A46 00 (201)	Artis 4179 43 (60)	Loop & Friends 5144 00 (203)	Collaro 4A21 38 (78)	Artis 4178 41 (60)

Semi-recessed washbasin

550 mm Rectangle	550 mm Rectangle
	
Avento 4A06 55 (64)	Memento 4133 55 (285)





Built-in washbasin

505 mm Oval	570 mm Oval	660 mm Oval
		
Loop & Friends 6155 10 (204)	Loop & Friends 6155 20 (204)	Loop & Friends 6155 30 (204)



WASHBASINS ACCORDING TO SHAPE AND DIMENSION





OVERVIEW

Built-in washbasin







510 mm Rectangle	600 mm Rectangle	630 mm Rectangle	675 mm Rectangle	390 mm Round
				
Loop & Friends 6145 10 (205)	Loop & Friends 6145 00 (205)	Hommage 7102 63 (147)	Loop & Friends 6145 20 (205)	Loop & Friends 6140 39 (204)

Undercounter washbasin

450 mm Round	430 mm Oval	455 mm Oval	485 mm Oval	500 mm Oval
				
Loop & Friends 6140 45 (204)	Loop & Friends 6161 10 (205)	Evana 6147 46 (100)	Loop & Friends 6161 20 (205)	Evana 6147 00 (100)

540 mm Oval	560 mm Oval	615 mm Oval	450 mm Rectangle	495 mm Rectangle
				
Architectura 4176 60 (47)	Loop & Friends 6161 30 (205)	Evana 6144 00 (100)	Loop & Friends 6163 10 (206)	Tube 4152 50 (331)

Undercounter washbasin

535 mm Rectangle	540 mm Rectangle	540 mm Rectangle	615 mm Rectangle	330 mm Round	380 mm Round
					
Lunea 5122 53 (208)	Architectura 4177 60 (47)	Loop & Friends 6163 00 (206)	Loop & Friends 6163 20 (206)	Loop & Friends 6180 33 (205)	Loop & Friends 6180 38 (205)

WASHBASINS ACCORDING TO SHAPE AND DIMENSION

OVERVIEW

Handwashbasin

360 mm Rectangle



360 mm Rectangle



370 mm Rectangle



Avento

4300 3R (65)

Avento

4300 3L (65)

Subway 2.0

7317 37 (310)

Handwashbasin

370 mm Rectangle



400 mm Rectangle



430 mm Rectangle



450 mm Rectangle



450 mm Rectangle



450 mm Rectangle



Subway 3.0

4370 37 (294)

Memento 2.0

4323 40 (220)

Finion

4364 43 (108)

Avento

7358 45 (64)

Collaro

4334 45 (77)

Subway 2.0

7315 45 (309)

Handwashbasin

450 mm Rectangle



500 mm Rectangle



500 mm Rectangle



500 mm Rectangle



500 mm Rectangle



Subway 3.0

4370 45 (293)

Collaro

4334 50 (76)

Subway 2.0

7315 50 (309)

Subway 3.0

4370 50 (293)

Venticello

4124 50 (336)

Corner handwashbasin

Quarter circle



Quarter circle



Subway 2.0

7319 45 (311)





Subway 3.0

4371 46 (294)







OVERVIEW TOILETS

OVERVIEW



Washdown toilet, rimless

wall-mounted	wall-mounted	wall-mounted	wall-mounted	wall-mounted
				
Antheus 4608 R0 (37)	Architectura 5684 R0 (50)	Architectura 5685 R0 (52)	Finion 4664 R0 (109)	Memento 2.0 4633 R0 (221)

Washdown toilet, rimless

wall-mounted	wall-mounted	wall-mounted	wall-mounted	Washdown toilet wall-mounted	wall-mounted
					
Subway 2.0 5614 A1 (313)	Subway 2.0 5614 R0 (206, 312)	Subway 3.0 4670 T0 (295)	Venticello 4611 R0 (337)	Architectura 5684 10 (51)	Homage 6661 B0 (147)

Washdown toilet

wall-mounted	wall-mounted	Combi-Pack wall-mounted
		
Subway 6600 10 (327)	Subway 2.0 5600 10 (315)	Architectura 5684 H1 (51)

Rimless Combi-Pack

wall-mounted	wall-mounted	wall-mounted	wall-mounted
			
Architectura 5684 HR (50)	Architectura 5685 HR (52)	Avento 5656 RS (66)	Avento 5656 HR (66)

Rimless Combi-Pack

wall-mounted	wall-mounted	wall-mounted	wall-mounted
			
Subway 2.0 5614 R2 (314)	Subway 3.0 4670 TS (61, 79, 295)	Venticello 4611 RS (337)	Venticello 4611 RL (338)

OVERVIEW TOILETS

OVERVIEW

**Shower-toilet,
wash-down toilet,
rimless**

wall-mounted



ViClean

V0E1 00 (365)

Washout toilet

wall-mounted



Subway

6603 10 (327)

**Washdown WC
Comfort, rimless**

wall-mounted



Subway 2.0

4609 R0 (317)

**Washdown WC
Compact, rimless**

wall-mounted



Subway 2.0

5606 R0 (316)

**Compact washdown
toilet**

wall-mounted



Subway 2.0

5606 10 (317)

Washdown toilet, rimless

floor-standing



Subway 2.0

5602 R0 (318)

floor-standing



Subway 3.0

4671 T0 (296)

OVERVIEW TOILETS

Washdown WC for close-coupled WC-suite, rimless

floor-standing



Avento
5644 R0 (66)

floor-standing



Subway 2.0
5617 R0 (319)

Washdown WC for close-coupled WC-suite, rimless

floor-standing



Venticello
4612 R0 (338)

Washdown toilet for close-coupled WC-suite

floor-standing



Subway
6610 10 (328)

OVERVIEW BIDETS

OVERVIEW

Bidet

wall-mounted



Avento
5405 00 (65)

wall-mounted



Finion
4465 00 (109)

wall-mounted



Memento 2.0
4433 00 (221)

wall-mounted



Subway 2.0
5400 00 (311)

wall-mounted



Subway 3.0
4470 00 (295)

Bidet

wall-mounted



Venticello
4411 00 (337)

floor-standing



Subway 2.0
5401 00 (312)

Bidet compact

wall-mounted



Subway 2.0
5406 00 (311)

OVERVIEW SIPHONIC URINALS

Siphonic urinal

concealed water inlet
concealed outlet



Architectura
5586 00 (57)

concealed water inlet
concealed outlet



Architectura
5587 00 (58)

concealed water inlet
Outlet may be concealed depending on the type of extractor section



Architectura
5574 00 (56)

concealed water inlet
Outlet may be concealed depending on the type of extractor section



Subway
7513 00 (67, 320, 329)

concealed water inlet
Outlet may be concealed depending on the type of extractor section



Subway
7513 01 (67, 320, 329)

Rimless siphonic urinal

concealed water inlet
Outlet may be concealed depending on the type of extractor section



Venticello
5504 R0 (110, 222, 339)

concealed water inlet
Outlet may be concealed depending on the type of extractor section



Venticello
5504 R1 (110, 222, 339)

ANTHEUS

Sanitaryware and Bathroom Furniture

- Premium segment
- Matching furniture programme Antheus
- Matching bath: Antheus, Theano

PRO.VILLEROY-BOCH.COM/TECHNICALDRAWINGS



ANTHEUS



Ceramic colours



R1 = White Alpin
CeramicPlus



RW = Stone
White
CeramicPlus

Front- / Body colours



PV = American
Walnut



PW = Black Ash

Colours countertop



RC = Carrara



RP = Nero
Marquina

ANTHEUS

€ excl. VAT

Registered design

Please order tap fittings and soap dispenser separately

VANITY WASHBASIN

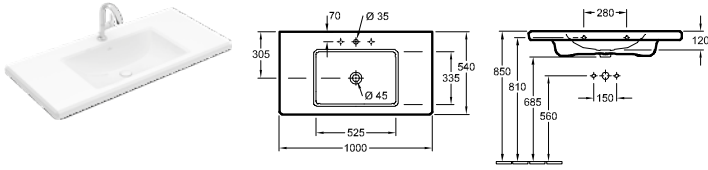

Article number	Description		plus R1	plus RW		pcs/ pal.	kg/ pc.
4A09 A2 XX	1000 x 540 mm 				-	6	30,9

wall fixation, matching furniture programme: Antheus



For further information about matching valves, see pages 380-383

Please note: unclosable outlet valve must be used with models without overflow

9221 49 00	WASHBASIN INSTALLATION ELEMENT 525 x 1120 x 75 mm For further ViConnect models, see pages 368-379		-	-		10	8,05
------------	--	---	---	---	--	----	------

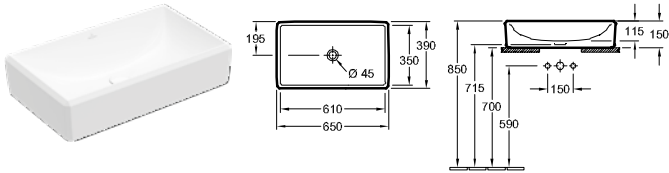
SURFACE-MOUNTED WASHBASIN



Article number	Description		plus R1	plus RW		pcs/ pal.	kg/ pc.
4A10 65 XX	650 x 388 mm for wall-mounted washbasin mixers or tall pillar tap fittings, without tap hole area 				-	10	18,2

incl. template, fastening set included, matching furniture programme: Antheus





For further information about matching valves, see pages 380-383

Please note: unclosable outlet valve must be used with models without overflow

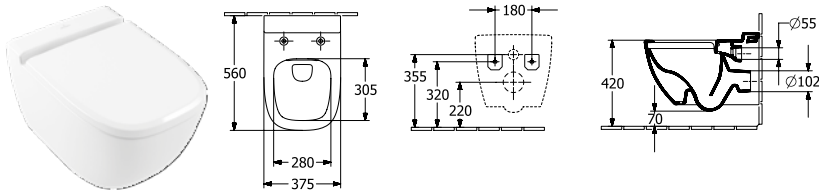

WASHDOWN TOILET, RIMLESS

DirectFlush



Article number	Description		plus R1	plus RW		pcs/ pal.	kg/ pc.
4608 R0 XX	375 x 560 mm  	 			-	12	25,8

wall-mounted, horizontal outlet, incl. fastening set "SupraFix 3.0", with water-saving AQUAREDUCT® system: flush volume 3 / 4,5 litres, not suitable for installation with flush valves

8M18 S1 XX	TOILET SEAT AND COVER with QuickRelease and SoftClosing hinges, hinges in stainless steel				-	108	2,7
9222 87 00	VIPROTECT SOUNDPROOFING SET (optional) incl. accessories		-	-		600	0,086
9224 65 00	TOILET INSTALLATION SYSTEM for dry-wall construction, low 450 x 1120 x 165 mm For further ViConnect models, see pages 368-379		-	-		8	19,78
9224 27 00	TOILET INSTALLATION SYSTEM for dry-wall construction, standard height 525 x 1120 x 135 mm For further ViConnect models, see pages 368-379		-	-		10	15,8

XX = Colour code to be indicated

R1 = White Alpin CeramicPlus, RW = Stone White CeramicPlus

ANTHEUS

€ excl. VAT

Registered design

Goods in stock, The washbasins are to be ordered separately.

Express Delivery These products are always in stock.

Front:

veneered MDF, silk matt lacquered finish in PV (19 mm)
 veneered MDF, matt black lacquered finish in PW (19 mm)
 horizontal grain in PV, PW
 interior colour to match décor

Body:

veneered chipboard, silk matt lacquered finish in PV (16 mm)
 veneered chipboard, matt black lacquered finish in PW (16 mm)
 horizontal grain in PV, PW
 interior colour direct-laminated Anthracite for vanity units
 interior colour to match décor for additional elements

Washbasin countertop:

marble in RC, RP (20 mm)

Frame:

high-gloss steel (10 mm)

Glass shelf:

Optiwhite single-pane safety glass (8 mm)

Drawers:

Slip-resistant base
 SoftClosing feature

Doors:

SoftClosing feature

Handles:

handle profile made from solid wood in PV, PW

Interior compartments :

removable wooden boxes made of solid wood with aluminium profile
 glass partitions (for vanity units without high-gloss steel frame)

Mirrors:

mirror (4 mm) bonded to frame

Mirror frame:

solid wood, silk matt lacquered finish in PV
 solid wood, matt black lacquered finish in PW

Mirror shelf:

Mirror (4 mm) on chipboard, melamine-laminated (8 mm)
 veneer edge silk matt lacquered finish in PV
 veneer edge, matt black lacquered finish in PW
 shelf, veneered chipboard, silk matt lacquered finish in PV (16 mm)
 shelf, veneered chipboard, matt black lacquered finish in PW (16 mm)

Towel holder:

high-gloss steel (3 mm)

Please note:

For further information such as tap fitting positions, installation and fastening dimensions etc. please see the technical drawings.

	MARBLE COUNTERTOP WITH FRAME MADE OF HIGH-GLOSS STEEL	MARBLE COUNTERTOP WITH FRAME MADE OF HIGH-GLOSS STEEL
Article number	B064 00 YY	B064 01 YY
Dimensions (w x h x d)	1200 x 745 x 570 mm	1200 x 745 x 570 mm
Version	without drilled tap holes	with drilled tap holes
For combination with	Antheus 4A10 65	Antheus 4A10 65
Equipped with	1x glass shelf 1x frame made of high-gloss steel 1x marble countertop	1x glass shelf 1x frame made of high-gloss steel 1x marble countertop
Please note	with wall-mount	with wall-mount
Installation	floor-standing	floor-standing
Scope of delivery	fastening set included	fastening set included
RC, RP		

XX = Insert front and body colour
 PV = American Walnut, PW = Black Ash

YY = Insert washbasin countertop colours
 RC = Carrara, RP = Nero Marquina







ANTHEUS

€ excl. VAT

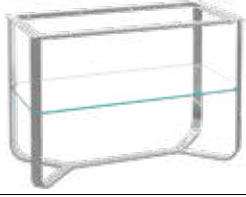
Registered design

Goods in stock, The washbasins are to be ordered separately.

Express Delivery These products are always in stock.

	FRAME MADE OF HIGH-GLOSS STEEL	
		
		
Article number	B064 50 00	
Dimensions (w x h x d)	1084 x 725 x 523 mm	
Equipped with	1x glass shelf 1x frame made of high-gloss steel	
Please note	with wall-mount	
Installation	floor-standing	
Scope of delivery	fastening set included	
	VANITY UNIT WITH FRAME MADE OF HIGH-GLOSS STEEL	VANITY UNIT
		
		
Article number	B065 10 XX	B066 10 XX
Dimensions (w x h x d)	927 x 852 x 500 mm	925 x 348 x 500 mm
Version	washbasin on the middle	washbasin on the middle
For combination with	Antheus 4A09 A2	Antheus 4A09 A2
Equipped with	1x frame made of high-gloss steel 1x pull-out compartment with non-slip mat 1x wooden box L 1x wooden box S	1x pull-out compartment with non-slip mat 1x wooden box L 1x wooden box S 2x wide glass drawer divider
Please note	with wall-mount	-
Installation	floor-standing	wall-mounted
Scope of delivery	space saving siphon, fastening set included	space saving siphon, fastening set included
PV, PW		

ANTHEUS

XX = Insert front and body colour
PV = American Walnut, PW = Black Ash

YY = Insert washbasin countertop colours
RC = Carrara, RP = Nero Marquina

ANTHEUS





€ excl. VAT

Registered design

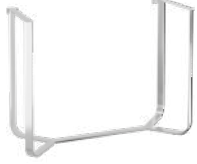
Goods in stock, The washbasins are to be ordered separately.

Express Delivery These products are always in stock.

	FRAME MADE OF HIGH-GLOSS STEEL
	
	Express Delivery
Article number	B065 50 00
Dimensions (w x h x d)	928 x 852 x 494 mm
For combination with	Antheus 4A09 A2
Equipped with	1x frame made of high-gloss steel
Please note	with wall-mount
Installation	floor-standing
Scope of delivery	fastening set included

	TALL CABINET	TALL CABINET	SIDE CABINET	SIDE CABINET
				
	Express Delivery	Express Delivery	Express Delivery	Express Delivery
Article number	B068 00 XX	B068 01 XX	B067 00 XX	B067 01 XX
Dimensions (w x h x d)	480 x 1700 x 200 mm	480 x 1700 x 200 mm	400 x 850 x 400 mm	400 x 850 x 400 mm
Hinges	hinges on left	hinges on right	hinges on left	hinges on right
Equipped with	2x door 1x fixed shelf 4x glass shelf	2x door 1x fixed shelf 4x glass shelf	1x door 1x pull-out compartment with non-slip mat 1x glass shelf	1x door 1x pull-out compartment with non-slip mat 1x glass shelf
Installation	wall-mounted	wall-mounted	wall-mounted	wall-mounted
Scope of delivery	fastening set included	fastening set included	fastening set included	fastening set included
PV, PW				

	MIRROR SHELF	MIRROR
		
	Express Delivery	Express Delivery
Article number	B306 00 XX	B305 00 XX
Dimensions (w x h x d)	600 x 1400 x 178 mm	850 x 850 x 35 mm, 850 mm Diameter
Equipped with	4x shelf on each side	with solid wood frame
Installation	wall-mounted	wall-mounted
Scope of delivery	fastening set included	fastening set included
PV, PW		

XX = Insert front and body colour
PV = American Walnut, PW = Black Ash

YY = Insert washbasin countertop colours
RC = Carrara, RP = Nero Marquina

ANTHEUS



€ excl. VAT

Registered design

Goods in stock, The washbasins are to be ordered separately.

Express Delivery

These products are always in stock.

	TOWEL RAIL
	
	
Article number	B069 80 00
Dimensions (w x h x d)	800 x 38 x 80 mm
Colour	high-gloss steel
Please note	for wall-mounting
Scope of delivery	fastening set included

ANTHEUS

XX = Insert front and body colour
 PV = American Walnut, PW = Black Ash

YY = Insert washbasin countertop colours
 RC = Carrara, RP = Nero Marquina

ARCHITECTURA

Bath ceramic

- Profi segment

PRO.VILLEROY-BOCH.COM/TECHNICALDRAWINGS



ARCHITECTURA



Ceramic colours



01 = White Alpin



R1 = White Alpin
CeramicPlus



T2 = White Alpin
AntiBac
CeramicPlus

ARCHITECTURA

€ excl. VAT

Registered design

Please order tap fittings and soap dispenser separately

UNDERCOUNTER WASHBASIN

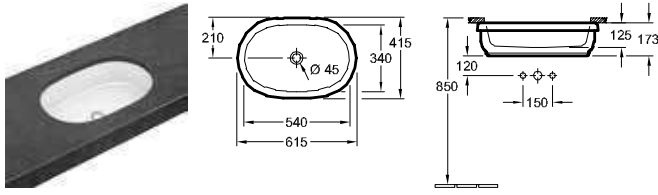

Article number	Description	01	plus R1	plus T2		pcs/ pal.	kg/ pc.
4176 60 XX	540 x 340 mm without tap hole area			-	-	10	20,68
4176 61 XX	540 x 340 mm without tap hole area			-	-	10	20,68

outside surface glazed, the hole for the washbasin can only be cut out using the original washbasin because tolerances of several millimetres are possible, fastening set included

For further information about matching valves, see pages 380-383

Please note: unclosable outlet valve must be used with models without overflow

UNDERCOUNTER WASHBASIN

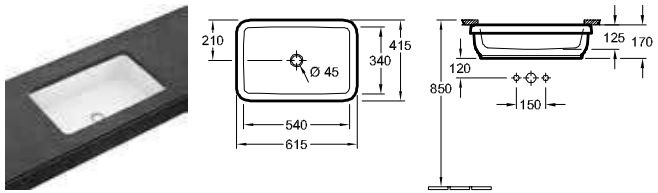

Article number	Description	01	plus R1	plus T2		pcs/ pal.	kg/ pc.
4177 60 XX	540 x 340 mm without tap hole area			-	-	10	21,2
4177 61 XX	540 x 340 mm without tap hole area			-	-	10	21,2

outside surface glazed, the hole for the washbasin can only be cut out using the original washbasin because tolerances of several millimetres are possible, fastening set included

For further information about matching valves, see pages 380-383

Please note: unclosable outlet valve must be used with models without overflow

XX = Colour code to be indicated

01 = White Alpin, R1 = White Alpin CeramicPlus, T2 = White Alpin AntiBac CeramicPlus

ARCHITECTURA

€ excl. VAT

Registered design

Please order tap fittings and soap dispenser separately

ARCHITECTURA

XX = Colour code to be indicated

01 = White Alpin, R1 = White Alpin CeramicPlus, T2 = White Alpin AntiBac CeramicPlus

ARCHITECTURA

€ excl. VAT





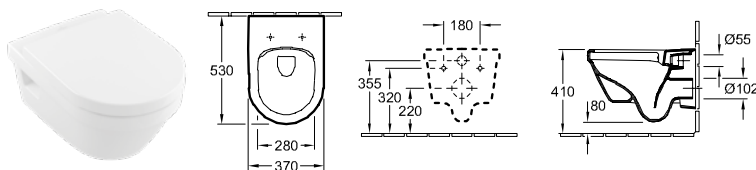

Registered design

Please order tap fittings and soap dispenser separately

WASHDOWN TOILET, RIMLESS

previously Omnia Architectura, DirectFlush





Article number	Description	01	C plus R1	C plus T2		pcs/ pal.	kg/ pc.
5684 R0 XX	370 x 530 mm				-	14	20,3
wall-mounted, horizontal outlet, with water-saving AQUAREDUCT® system: flush volume 3 / 4,5 litres, not suitable for installation with flush valves							
98M9 C1 01	TOILET SEAT AND COVER with QuickRelease and SoftClosing hinges, hinges in stainless steel		-	-	-	144	2,52
98M9 D1 01	TOILET SEAT AND COVER hinges in stainless steel		-	-	-	90	2,57
9M70 S1 01	TOILET SEAT AND COVER SLIMSEAT with QuickRelease and SoftClosing hinges, hinges in stainless steel		-	-	-	90	2,971
9M70 61 01	TOILET SEAT AND COVER SLIMSEAT hinges in stainless steel		-	-	-	90	2,971
9M63 61 01	SEAT with continuous hinge bolt, hinges in stainless steel		-	-	-	90	1,68
9953 00 00	FASTENING FRAME (optional)		-	-	-		2,93
9961 00 00	FASTENING SET (optional)		-	-	-		0,301
9222 87 00	VIPROTECT SOUNDPROOFING SET (optional) incl. accessories		-	-	-	600	0,086
9224 27 00	TOILET INSTALLATION SYSTEM for dry-wall construction, standard height 525 x 1120 x 135 mm For further ViConnect models, see pages 368-379		-	-	-	10	15,8

COMBI-PACK

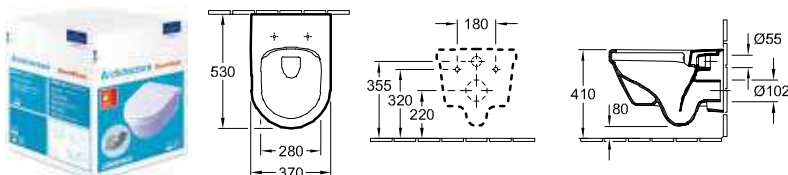
previously Omnia Architectura, DirectFlush



Article number	Description	01	C plus R1	C plus T2		pcs/ pal.	kg/ pc.
5684 HR XX	individual packaging materials, wall-mounted, horizontal outlet composed of: Washdown WC DirectFlush 5684 R0 XX, WC-seat and cover with QuickRelease and Soft-Closing hinges 98M9 C1 01				-	12	24,2

XX = Colour code to be indicated

01 = White Alpin, R1 = White Alpin CeramicPlus, T2 = White Alpin AntiBac CeramicPlus

ARCHITECTURA

€ excl. VAT





Registered design

Please order tap fittings and soap dispenser separately

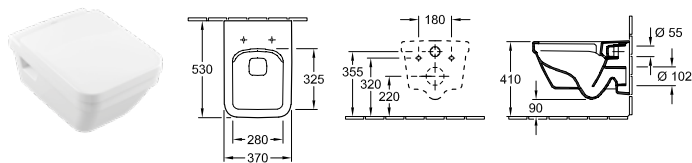
WASHDOWN TOILET, RIMLESS

DirectFlush





Article number	Description	01	plus R1	plus T2		pcs/ pal.	kg/ pc.
5685 R0 XX	370 x 530 mm					14	22
wall-mounted, horizontal outlet, with water-saving AQUAREDUCT® system: flush volume 3 / 4,5 litres, not suitable for installation with flush valves							
9M58 S1 01	TOILET SEAT AND COVER with QuickRelease and SoftClosing hinges, hinges in stainless steel		-	-	-	72	2,71
9M60 61 01	TOILET SEAT AND COVER hinges in stainless steel		-	-	-	144	2,63
9M81 S1 01	TOILET SEAT AND COVER SLIMSEAT with QuickRelease and SoftClosing hinges, hinges in stainless steel		-	-	-	40	2,65
9961 00 00	FASTENING SET (optional)		-	-	-		0,301
9953 00 00	FASTENING FRAME (optional)		-	-	-		2,93
9222 87 00	VIPROTECT SOUNDPROOFING SET (optional) incl. accessories		-	-	-	600	0,086
9224 27 00	TOILET INSTALLATION SYSTEM for dry-wall construction, standard height 525 x 1120 x 135 mm For further ViConnect models, see pages 368-379		-	-	-	10	15,8

COMBI-PACK

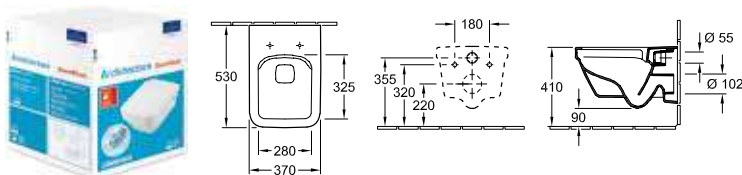
DirectFlush



Article number	Description	01	plus R1	plus T2		pcs/ pal.	kg/ pc.
5685 HR XX	individual packaging materials, wall-mounted, horizontal outlet composed of: Washdown WC DirectFlush 5685 R0 XX, WC-seat and cover with QuickRelease and Soft-Closing hinges 9M58 S1 01					12	22

XX = Colour code to be indicated

01 = White Alpin, R1 = White Alpin CeramicPlus, T2 = White Alpin AntiBac CeramicPlus

ARCHITECTURA

€ excl. VAT





Registered design

Please order tap fittings and soap dispenser separately

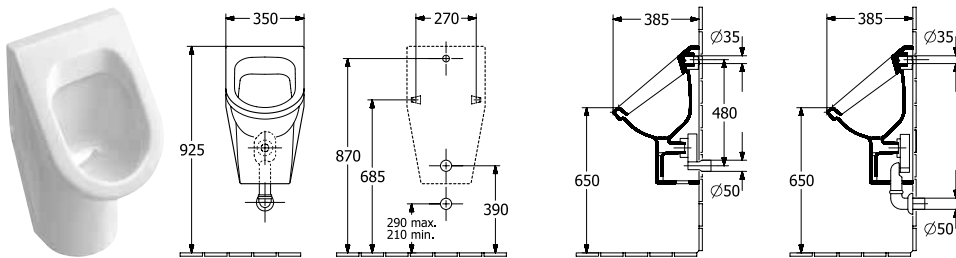
SIPHONIC URINAL

previously Omnia Architectura



Article number	Description		01	plus R1	plus T2		pcs/ pal.	kg/ pc.
5574 00 XX	355 x 620 x 385 mm splash-reducing	AntiBac			-	-	20	18,55
5574 05 XX	355 x 620 x 385 mm splash-reducing with target				-	-	20	18,55
5574 20 XX	355 x 620 x 385 mm splash-reducing, with ceramic strainer	AntiBac			-	-	20	18,55
5574 25 XX	355 x 620 x 385 mm splash-reducing, with ceramic strainer with target				-	-	20	18,55
fastening set included, concealed water inlet, Outlet may be concealed depending on the type of extractor section								
9326 00 00	EXTRACTOR (optional) horizontal outlet, Flush volume: 1,0 l		-	-	-			0,164
9327 00 00	EXTRACTOR (optional) vertical outlet, Flush volume: 1,0 l		-	-	-			0,175
9319 00 00	CONNECTION PIECES (optional) comprising: collar, outlet elbow, drain pipe 150 mm long		-	-	-			0,232
9933 00 00	WATER-INLET CONNECTOR (optional)		-	-	-			0,2
9190 B1 00	PRODETECT 2 RADAR FLUSH CONTROL FOR URINALS (optional) electronic urinal flushing system, battery-operated (6 x 1.5 V AAA required), pipe thread inlet connector 1/2"	Pro Detect 2	-	-	-			0,974
9190 N1 00	PRODETECT 2 RADAR FLUSH CONTROL FOR URINALS (optional) electronic urinal flushing system, mains-powered (110 - 240 V), Bluetooth-compatible thanks to optional adapter, pipe thread inlet connector 1/2"	Pro Detect 2	-	-	-			1,006
9190 61 00	BLUETOOTH ADAPTER (optional) Bluetooth-adapter for 9190 N1 for wireless function change and maintenance, incl. free app for iOS and Android, suitable for smartphones and tablets	Pro Detect 2	-	-	-			0,03
9190 57 00	ADAPTER FOR MAINS POWER SUPPLY CONNECTION (optional) recommendation: to install with power supply unit 9190 N1 00	Pro Detect 2	-	-	-			0,038
9221 85 00	URINAL INSTALLATION SYSTEM FOR PRODETECT 525 x 1120 x 80 mm For further ViConnect models, see pages 368-379		-	-	-		10	7,15
9219 89 00	URINAL INSTALLATION SYSTEM 525 x 1120 x 98 mm For further ViConnect models, see pages 368-379		-	-	-			8,05

XX = Colour code to be indicated

01 = White Alpin, R1 = White Alpin CeramicPlus, T2 = White Alpin AntiBac CeramicPlus

ARCHITECTURA

€ excl. VAT





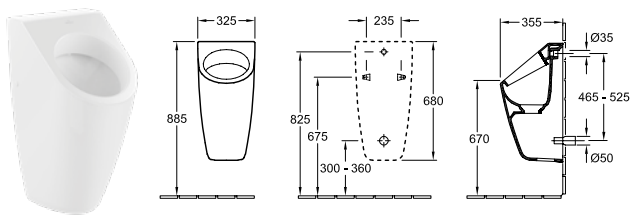

Registered design

Please order tap fittings and soap dispenser separately

SIPHONIC URINAL



ARCHITECTURA

Article number	Description	01	plus R1	plus T2		pcs/ pal.	kg/ pc.
5586 00 XX	325 x 680 x 355 mm 			-	-	9	22,6
5586 05 XX	325 x 680 x 355 mm with target			-	-	9	22,6
Incl. outlet, consisting of ViChange siphon cartridge and ceramic outlet cover, fastening set included, concealed water inlet, concealed outlet							
8706 20 00	VICHANGE SIPHON CARTRIDGE (required spare part) 1 ViChange replacement siphon cartridge incl. 1 glove, 1 disposal bag per set	-	-	-			0,097
8706 10 00	VICHANGE SIPHON CARTRIDGE (required spare part) 10 ViChange replacement siphon cartridges incl. 1 glove, 1 disposal bag per set	-	-	-			0,085
9933 00 00	WATER-INLET CONNECTOR (optional)	-	-	-			0,2
9220 67 00	FLEXIBLE WATER-INLET CONNECTOR (optional) not suitable for assembly with ProDetect	-	-	-			0,29
9190 B1 00	PRODETECT 2 RADAR FLUSH CONTROL FOR URINALS (optional) electronic urinal flushing system, battery-operated (6 x 1.5 V AAA required), pipe thread inlet connector 1/2"		-	-	-		0,974
9190 N1 00	PRODETECT 2 RADAR FLUSH CONTROL FOR URINALS (optional) electronic urinal flushing system, mains-powered (110 - 240 V), Bluetooth-compatible thanks to optional adapter, pipe thread inlet connector 1/2"		-	-	-		1,006
9190 61 00	BLUETOOTH ADAPTER (optional) Bluetooth-adapter for 9190 N1 for wireless function change and maintenance, incl. free app for iOS and Android, suitable for smartphones and tablets		-	-	-		0,03
9190 57 00	ADAPTER FOR MAINS POWER SUPPLY CONNECTION (optional) recommendation: to install with power supply unit 9190 N1 00		-	-	-		0,038
9221 85 00	URINAL INSTALLATION SYSTEM FOR PRODETECT 525 x 1120 x 80 mm For further ViConnect models, see pages 368-379		-	-	-	10	7,15
9219 89 00	URINAL INSTALLATION SYSTEM 525 x 1120 x 98 mm For further ViConnect models, see pages 368-379		-	-	-		8,05

XX = Colour code to be indicated

01 = White Alpin, R1 = White Alpin CeramicPlus, T2 = White Alpin AntiBac CeramicPlus

ARCHITECTURA





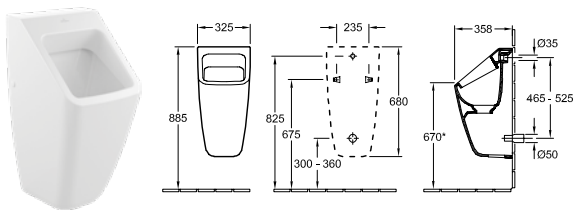

€ excl. VAT

Registered design

Please order tap fittings and soap dispenser separately

SIPHONIC URINAL



Article number	Description	01	plus R1	plus T2		pcs/ pal.	kg/ pc.
5587 00 XX	325 x 680 x 355 mm 			-	-	9	24,3
5587 05 XX	325 x 680 x 355 mm with target			-	-	9	24,3
Incl. outlet, consisting of ViChange siphon cartridge and ceramic outlet cover, fastening set included, concealed water inlet, concealed outlet							
8706 20 00	VICHANGE SIPHON CARTRIDGE (required spare part) 1 ViChange replacement siphon cartridge incl. 1 glove, 1 disposal bag per set	-	-	-			0,097
8706 10 00	VICHANGE SIPHON CARTRIDGE (required spare part) 10 ViChange replacement siphon cartridges incl. 1 glove, 1 disposal bag per set	-	-	-			0,085
9933 00 00	WATER-INLET CONNECTOR (optional)	-	-	-			0,2
9220 67 00	FLEXIBLE WATER-INLET CONNECTOR (optional) not suitable for assembly with ProDetect	-	-	-			0,29
9190 B1 00	PRODETECT 2 RADAR FLUSH CONTROL FOR URINALS (optional) electronic urinal flushing system, battery-operated (6 x 1.5 V AAA required), pipe thread inlet connector 1/2"		-	-	-		0,974
9190 N1 00	PRODETECT 2 RADAR FLUSH CONTROL FOR URINALS (optional) electronic urinal flushing system, mains-powered (110 - 240 V), Bluetooth-compatible thanks to optional adapter, pipe thread inlet connector 1/2"		-	-	-		1,006
9190 61 00	BLUETOOTH ADAPTER (optional) Bluetooth-adapter for 9190 N1 for wireless function change and maintenance, incl. free app for iOS and Android, suitable for smartphones and tablets		-	-	-		0,03
9190 57 00	ADAPTER FOR MAINS POWER SUPPLY CONNECTION (optional) recommendation: to install with power supply unit 9190 N1 00		-	-	-		0,038
9221 85 00	URINAL INSTALLATION SYSTEM FOR PRODETECT 525 x 1120 x 80 mm For further ViConnect models, see pages 368-379		-	-	-	10	7,15
9219 89 00	URINAL INSTALLATION SYSTEM 525 x 1120 x 98 mm For further ViConnect models, see pages 368-379		-	-	-		8,05

XX = Colour code to be indicated

01 = White Alpin, R1 = White Alpin CeramicPlus, T2 = White Alpin AntiBac CeramicPlus

ARTIS

Bath ceramic

PRO.VILLEROY-BOCH.COM/TECHNICALDRAWINGS

- Premium segment
- Matching furniture programme Finion, Legato
- Designed to match all mirror collections
- Designed to match all mirror cabinet collections
- Matching baths Antheus, Aveo New Generation, Collaro, Finion, La Belle, La Belle Excellence, Loop & Friends, Oberon 2.0, Squaro Excellence, Squaro Edge 12, Theano



Ceramic colours



01 = White Alpin

R1 = White Alpin
CeramicPlus

RW = Stone
White
CeramicPlus

Ceramic colours Bicolour



BCW0 = Fog

BCW2 = Ocean

BCT0 = Powder

BCT7 = French
Linen

BCT8 = Coal
Black

BCW8 = Rust

BCW9 = Indian
Summer

BCS8 = Sage
Green

BCS9 =
Bordeaux

Due to the different materials used, there may be variations in colour between the images and the actual products. For further information, see page 15

ARTIS

€ excl. VAT

Please order tap fittings and soap dispenser separately

SURFACE-MOUNTED WASHBASIN

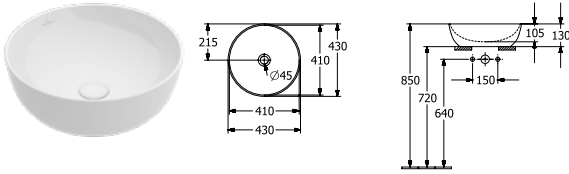

Article number	Description	01	plus R1	plus RW	BC	pcs/ pal.	kg/ pc.
4179 43 XX	430 mm Diameter for wall-mounted washbasin mixers or tall pillar tap fittings, without tap hole area					18	8.2

incl. template, fastening set included, matching furniture programme: Legato, Finion
For further information about matching valves, see pages 380-383
Please note: unclosable outlet valve must be used with models without overflow

SURFACE-MOUNTED WASHBASIN

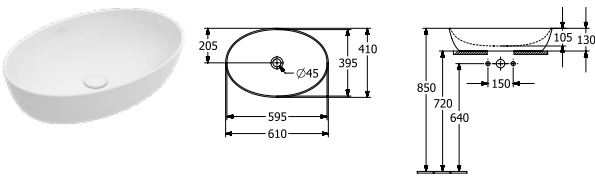

Article number	Description	01	plus R1	plus RW	BC	pcs/ pal.	kg/ pc.
4198 61 XX	610 x 410 mm for wall-mounted washbasin mixers or tall pillar tap fittings, without tap hole area					10	10.5

incl. template, fastening set included, matching furniture programme: Legato, Finion
For further information about matching valves, see pages 380-383
Please note: unclosable outlet valve must be used with models without overflow

SURFACE-MOUNTED WASHBASIN

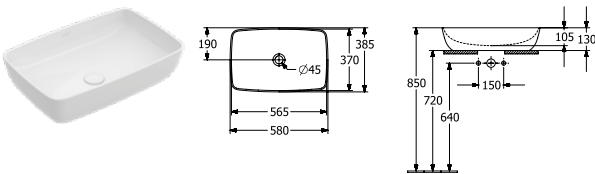

Article number	Description	01	plus R1	plus RW	BC	pcs/ pal.	kg/ pc.
4172 58 XX	580 x 380 mm for wall-mounted washbasin mixers or tall pillar tap fittings, without tap hole area					10	11.5

incl. template, fastening set included, matching furniture programme: Legato, Finion
For further information about matching valves, see pages 380-383
Please note: unclosable outlet valve must be used with models without overflow

SURFACE-MOUNTED WASHBASIN

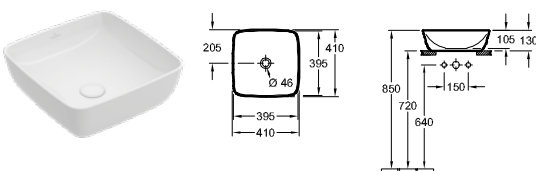

Article number	Description	01	plus R1	plus RW	BC	pcs/ pal.	kg/ pc.
4178 41 XX	410 x 410 mm for wall-mounted washbasin mixers or tall pillar tap fittings, without tap hole area					12	8.2

incl. template, fastening set included, matching furniture programme: Legato, Finion
For further information about matching valves, see pages 380-383
Please note: unclosable outlet valve must be used with models without overflow

The colours Bicolour are made to order. Please enquire about delivery times when ordering.

XX = Colour code to be indicated
01 = White Alpin, R1 = White Alpin CeramicPlus, RW = Stone White CeramicPlus
Bicolour:
BCW0 = Fog, BCW2 = Ocean, BCT0 = Powder, BCT7 = French Linen, BCT8 = Coal Black, BCW8 = Rust, BCW9 = Indian Summer, BCS8 = Sage Green, BCS9 = Bordeaux

ARTIS

ARTIS

€ excl. VAT

Please order tap fittings and soap dispenser separately

COMBI-PACK

TwistFlush

We recommend the SUBWAY 3.0 combi-pack for ARTIS

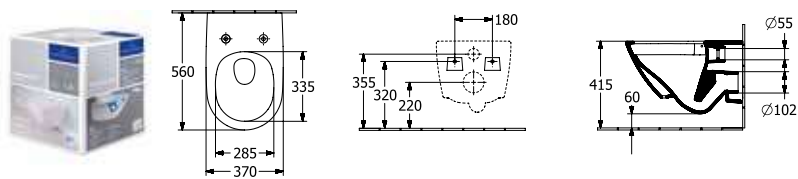

Article number	Description	01	plus R1	plus RW	BC	pcs/ pal.	kg/ pc.
4670 TS XX	individual packaging materials, wall-mounted, horizontal outlet composed of: Washdown WC TwistFlush 4670 T0 XX, WC-seat and cover with Quick-Release and SoftClosing hinges 8M42 S1 01			-	-	12	25,6



ARTIS

The colours Bicolour are made to order. Please enquire about delivery times when ordering.

XX = Colour code to be indicated

01 = White Alpin, R1 = White Alpin CeramicPlus, RW = Stone White CeramicPlus

Bicolour:

BCW0 = Fog, BCW2 = Ocean, BCT0 = Powder, BCT7 = French Linen, BCT8 = Coal Black, BCW8 = Rust, BCW9 = Indian Summer, BCS8 = Sage Green, BCS9 = Bordeaux

AVENTO

Sanitaryware and Bathroom Furniture

- Mainstream segment
- Matching furniture programme Avento
- Designed to match all mirror collections
- Designed to match all mirror cabinet collections
- matching wellness programme Avento

PRO.VILLEROY-BOCH.COM/TECHNICALDRAWINGS



AVENTO

Ceramic colours



01 = White Alpin R1 = White Alpin CeramicPlus RW = Stone White CeramicPlus

Front- / Body colours



B1 = Crystal Grey B3 = Crystal Black B4 = Crystal White PN = Elm Impresso RH = Oak Kansas RK = Stone Oak VH = Arizona Oak VJ = Nordic Oak





AVENTO

€ excl. VAT

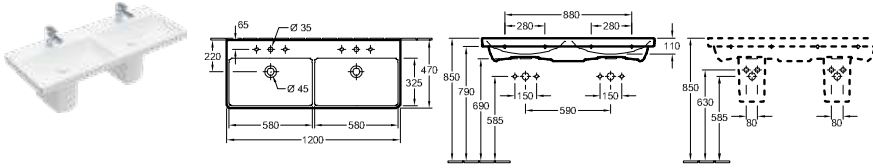
Please order tap fittings and soap dispenser separately



DOUBLE VANITY WASHBASIN



Article number	Description	01	plus R1	plus RW		pcs/ pal.	kg/ pc.
4A23 CK XX	1200 x 470 mm 2x    					-	8 32,5

matching furniture programme: Avento

For further information about matching valves and CAP, see pages 380-383

5244 00 XX	TRAP COVER cannot be combined with 3-hole tap fittings, incl. fastening set "SmartFix"						40 5,59
9221 49 00	WASHBASIN INSTALLATION ELEMENT 525 x 1120 x 75 mm For further ViConnect models, see pages 368-379						10 8,05

VANITY WASHBASIN

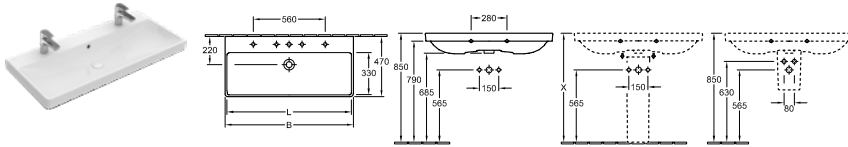



Article no.	B	L
4156A4XX	1000	980
4156A5XX	1000	980
415680XX	800	770

Article number	Description	01	plus R1	plus RW		pcs/ pal.	kg/ pc.
4156 A4 XX	1000 x 470 mm 2x  					-	8 25
4156 A5 XX	1000 x 470 mm    					-	8 25
4156 80 XX	800 x 470 mm    					-	12 20,5

matching furniture programme: Avento







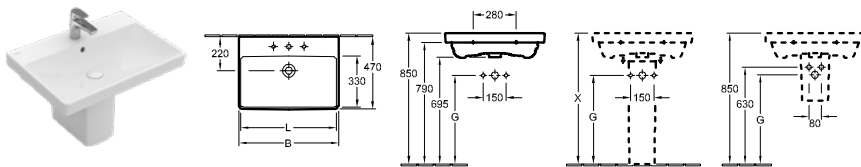

For further information about matching valves and CAP, see pages 380-383

5244 00 XX	TRAP COVER cannot be combined with 3-hole tap fittings, incl. fastening set "SmartFix"						40 5,59
9221 49 00	WASHBASIN INSTALLATION ELEMENT 525 x 1120 x 75 mm For further ViConnect models, see pages 368-379						10 8,05

WASHBASINS





Article no.	B	G	L
415865XX	650	575	620
415860XX	600	585	570

Article number	Description	01	plus R1	plus RW		pcs/ pal.	kg/ pc.
4158 65 XX	650 x 470 mm    					-	24 19
4158 60 XX	600 x 470 mm    					-	24 16,5

matching furniture programme: Avento

For further information about matching valves and CAP, see pages 380-383

5244 00 XX	TRAP COVER cannot be combined with 3-hole tap fittings, incl. fastening set "SmartFix"						40 5,59
9221 49 00	WASHBASIN INSTALLATION ELEMENT 525 x 1120 x 75 mm For further ViConnect models, see pages 368-379						10 8,05

XX = Colour code to be indicated

01 = White Alpin, R1 = White Alpin CeramicPlus, RW = Stone White CeramicPlus



AVENTO

€ excl. VAT

Please order tap fittings and soap dispenser separately

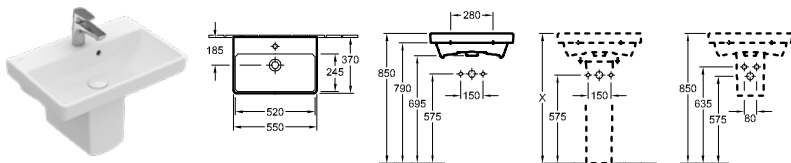
WASHBASIN COMPACT



Article number	Description	01	plus R1	plus RW		pcs/ pal.	kg/ pc.
4A00 55 XX	550 x 370 mm  				-	36	13



matching furniture programme: Avento

For further information about matching valves and CAP, see pages 380-383

5222 00 XX	TRAP COVER cannot be combined with 3-hole tap fittings, fastening set included			-	-	50	7,35
9221 49 00	WASHBASIN INSTALLATION ELEMENT 525 x 1120 x 75 mm For further ViConnect models, see pages 368-379		-	-	-	10	8,05

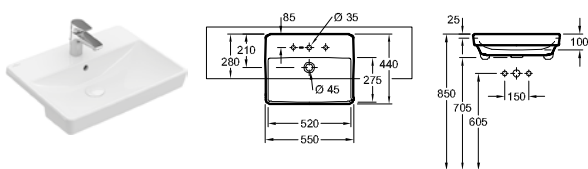
SEMI-RECESSED WASHBASIN



Article number	Description	01	plus R1	plus RW		pcs/ pal.	kg/ pc.
4A06 55 XX	550 x 440 mm  				-	12	14,7



incl. template, fastening set included

For further information about matching valves, see pages 380-383

Please note: unclosable outlet valve must be used with models without overflow

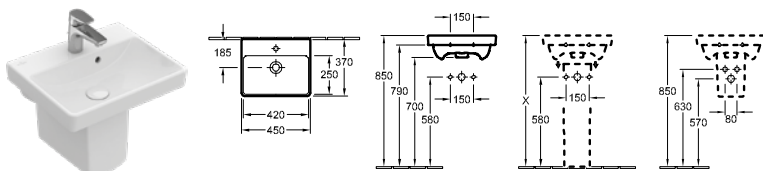
HANDWASHBASIN



Article number	Description	01	plus R1	plus RW		pcs/ pal.	kg/ pc.
7358 45 XX	450 x 370 mm  				-	48	10,4

matching furniture programme: Avento

For further information about matching valves, see pages 380-383

5222 00 XX	TRAP COVER cannot be combined with 3-hole tap fittings, fastening set included			-	-	50	7,35
9221 49 00	WASHBASIN INSTALLATION ELEMENT 525 x 1120 x 75 mm For further ViConnect models, see pages 368-379		-	-	-	10	8,05

XX = Colour code to be indicated

01 = White Alpin, R1 = White Alpin CeramicPlus, RW = Stone White CeramicPlus

AVENTO

€ excl. VAT

Please order tap fittings and soap dispenser separately

HANDWASHBASIN

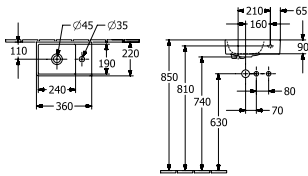

Article number	Description	01	plus R1	plus RW		pcs/ pal.	kg/ pc.
4300 3L XX	360 x 220 mm				-	90	5,5

basin left

For further information about matching valves, see pages 380-383

Please note: unclosable outlet valve must be used with models without overflow

HANDWASHBASIN

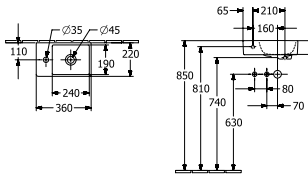

Article number	Description	01	plus R1	plus RW		pcs/ pal.	kg/ pc.
4300 3R XX	360 x 220 mm				-	90	5,5

basin right

For further information about matching valves, see pages 380-383

Please note: unclosable outlet valve must be used with models without overflow

BIDET

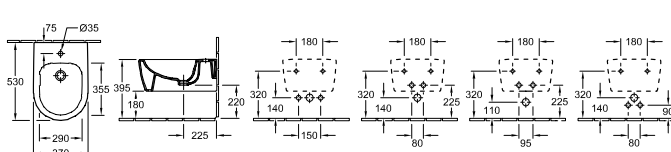

Article number	Description	01	plus R1	plus RW		pcs/ pal.	kg/ pc.
5405 00 XX	370 x 530 mm				-	12	18,9

wall-mounted, with fastening set for concealed fastening

For further information about matching valves, see pages 380-383

9953 00 00	FASTENING FRAME (optional)	-	-	-			2,93
9223 78 61	DESIGNER SIPHON (optional) chrome	-	-	-			0,522
9221 48 00	BIDET INSTALLATION SYSTEM 525 x 1120 x 100 mm For further ViConnect models, see pages 368-379		-	-	-	10	10,54

XX = Colour code to be indicated

01 = White Alpin, R1 = White Alpin CeramicPlus, RW = Stone White CeramicPlus

AVENTO

€ excl. VAT

Please order tap fittings and soap dispenser separately

COMBI-PACK DirectFlush

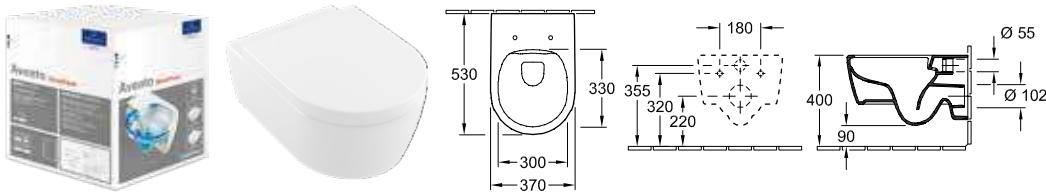

Article number	Description	01	plus R1	plus RW		pcs/ pal.	kg/ pc.
5656 HR XX	individual packaging materials, wall-mounted, horizontal outlet composed of: Washdown WC DirectFlush 5656 R0 XX, WC-seat with QuickRelease and SoftClosing hinges 9M77 C1 XX					12	22

COMBI-PACK DirectFlush

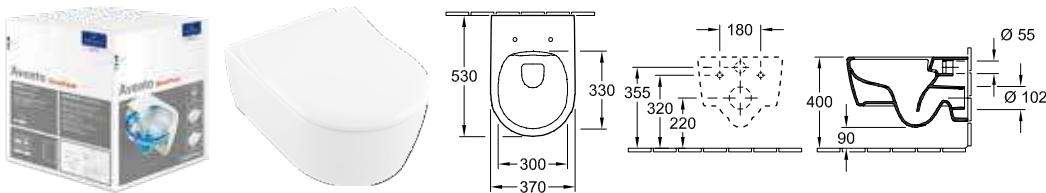

Article number	Description	01	plus R1	plus RW		pcs/ pal.	kg/ pc.
5656 RS XX	individual packaging materials, wall-mounted, horizontal outlet composed of: Washdown WC DirectFlush 5656 R0 XX, SlimSeat with QuickRelease and SoftClosing hinges 9M87 S1 01					12	22

WASHDOWN TOILET FOR CLOSE-COUPLED WC-SUITE, RIMLESS DirectFlush

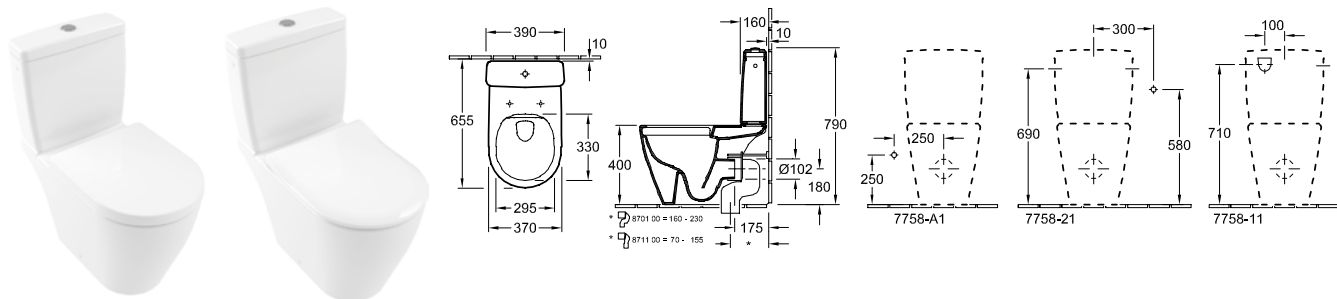

Article number	Description	01	plus R1	plus RW		pcs/ pal.	kg/ pc.
5644 R0 XX	370 x 640 mm					8	29

floor-standing, horizontal outlet, with fastening set for concealed fastening, with water-saving AQUAREDUCT® system: flush volume 3 / 4,5 litres

7758 11 XX	CISTERN water inlet from the sides or rear, flushing mechanism with DualFlush water-saving button, chrome					16	10,8
9M77 C1 XX	TOILET SEAT AND COVER with QuickRelease and SoftClosing hinges, hinges in stainless steel					108	2,61
9M87 S1 01	TOILET SEAT AND COVER SLIMSEAT with QuickRelease and SoftClosing hinges, hinges in stainless steel					90	2,91
8701 00 00	VARIO DRAINBEND for vertical outlet 160 - 230 mm						0,74
8711 00 00	VARIO DRAINBEND for vertical outlet 70 - 155 mm						0,72

XX = Colour code to be indicated

01 = White Alpin, R1 = White Alpin CeramicPlus, RW = Stone White CeramicPlus

AVENTO







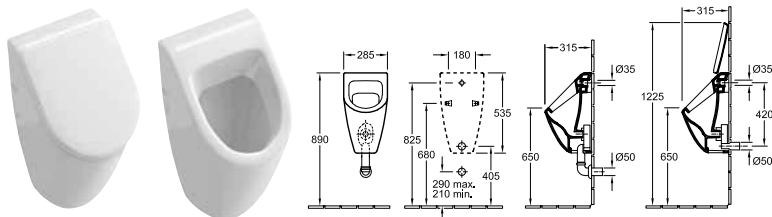

€ excl. VAT

Please order tap fittings and soap dispenser separately

SIPHONIC URINAL

We recommend the urinal from SUBWAY for use with AVENTO



Article number	Description	01	plus R1	plus RW		pcs/ pal.	kg/ pc.
7513 01 XX	285 x 535 x 315 mm for cover				-	15	16,82
7513 00 XX	285 x 535 x 315 mm without cover				-	15	16,82
with fastening set for concealed fastening, concealed water inlet. Outlet may be concealed depending on the type of extractor section							
9956 S1 XX	COVER with SoftClosing hinges, chrome hinges		-	-	-	90	2
9326 00 00	EXTRACTOR (optional) horizontal outlet, Flush volume: 1,0 l		-	-	-		0,164
9327 00 00	EXTRACTOR (optional) vertical outlet, Flush volume: 1,0 l		-	-	-		0,175
9319 00 00	CONNECTION PIECES (optional) comprising: collar, outlet elbow, drain pipe 150 mm long		-	-	-		0,232
9933 00 00	WATER-INLET CONNECTOR (optional)		-	-	-		0,2
9190 B1 00	PRODETECT 2 RADAR FLUSH CONTROL FOR URINALS (optional) electronic urinal flushing system, battery-operated (6 x 1.5 V AAA required), pipe thread inlet connector 1/2"		-	-	-		0,974
9190 N1 00	PRODETECT 2 RADAR FLUSH CONTROL FOR URINALS (optional) electronic urinal flushing system, mains-powered (110 - 240 V), Bluetooth-compatible thanks to optional adapter, pipe thread inlet connector 1/2"		-	-	-		1,006
9190 61 00	BLUETOOTH ADAPTER (optional) Bluetooth-adapter for 9190 N1 for wireless function change and maintenance, incl. free app for iOS and Android, suitable for smartphones and tablets		-	-	-		0,03
9190 57 00	ADAPTER FOR MAINS POWER SUPPLY CONNECTION (optional) recommendation: to install with power supply unit 9190 N1 00		-	-	-		0,038
9221 85 00	URINAL INSTALLATION SYSTEM FOR PRODETECT 525 x 1120 x 80 mm For further ViConnect models, see pages 368-379		-	-	-	10	7,15
9219 89 00	URINAL INSTALLATION SYSTEM 525 x 1120 x 98 mm For further ViConnect models, see pages 368-379		-	-	-		8,05

XX = Colour code to be indicated

01 = White Alpin, R1 = White Alpin CeramicPlus, RW = Stone White CeramicPlus

AVENTO

€ excl. VAT

Goods in stock, The washbasins are to be ordered separately.

Express Delivery These products are always in stock.

Front:
MDF with acrylic layer in B1, B3, B4 (19 mm)
coated chipboard in PN, RH, RK, VH, VJ (16 mm)
horizontal grain in PN, RH, RK, VH, VJ
interior colour to match décor

Body:
MDF with acrylic layer in B1, B3, B4 (19 mm)
coated chipboard in PN, RH, RK, VH, VJ (16 mm)

horizontal grain in PN, RH, RK, VH, VJ
interior colour to match décor

Drawers:
SoftClosing feature

Doors:
SoftClosing feature

Handles:
glossy chrome

Please note:

For further information such as tap fitting positions, installation and fastening dimensions etc. please see the technical drawings.

	VANITY UNIT	VANITY UNIT	VANITY UNIT	VANITY UNIT
Article number	A893 00 XX	A892 00 XX	A891 00 XX	
Dimensions (w x h x d)	1180 x 514 x 452 mm	980 x 514 x 452 mm	780 x 514 x 452 mm	
Version	washbasin on the middle	washbasin on the middle	washbasin on the middle	
For combination with	Avento 4A23 CK	Avento 4156 A4/A5	Avento 4156 80	
Equipped with	4x pull-out compartment	2x pull-out compartment	2x pull-out compartment	
Installation	wall-mounted	wall-mounted	wall-mounted	
Scope of delivery	fastening set included	fastening set included	fastening set included	
B1, B3, B4, PN, RH, RK, VH, VJ				
	VANITY UNIT	VANITY UNIT	VANITY UNIT	VANITY UNIT
Article number	A890 00 XX	A889 00 XX	A888 00 XX	A888 01 XX
Dimensions (w x h x d)	630 x 514 x 452 mm	580 x 514 x 452 mm	530 x 514 x 352 mm	530 x 514 x 352 mm
Version	washbasin on the middle	washbasin on the middle	washbasin on the middle	washbasin on the middle
Hinges	-	-	hinges on left	hinges on right
For combination with	Avento 4158 65	Avento 4158 60	Avento 4A00 55	Avento 4A00 55
Equipped with	2x pull-out compartment	2x pull-out compartment	1x door	1x door
Installation	wall-mounted	wall-mounted	wall-mounted	wall-mounted
Scope of delivery	fastening set included	fastening set included	fastening set included	fastening set included
B1, B3, B4, PN, RH, RK, VH, VJ				

XX = Insert front and body colour

B1 = Crystal Grey, B3 = Crystal Black, B4 = Crystal White, PN = Elm Impres-
so, RH = Oak Kansas, RK = Stone Oak, VH = Arizona Oak, VJ = Nordic Oak















AVENTO

AVENTO

€ excl. VAT

Goods in stock, The washbasins are to be ordered separately.

Express Delivery These products are always in stock.

	VANITY UNIT	VANITY UNIT	VANITY UNIT	VANITY UNIT
				
				
Article number	A887 00 XX	A887 01 XX	A876 00 XX	A876 01 XX
Dimensions (w x h x d)	430 x 514 x 352 mm	430 x 514 x 352 mm	340 x 514 x 202 mm	340 x 514 x 202 mm
Version	washbasin on the middle	washbasin on the middle	washbasin on the middle	washbasin on the middle
Hinges	hinges on left	hinges on right	hinges on left	hinges on right
For combination with	Avento 7358 45	Avento 7358 45	Avento 4300 3L/3R	Avento 4300 3L/3R
Equipped with	1x door	1x door	1x door	1x door
Installation	wall-mounted	wall-mounted	wall-mounted	wall-mounted
Scope of delivery	fastening set included	fastening set included	fastening set included	fastening set included
Please note	-	-	A bottle-trap is required when combining a hand-rinse washbasin with a vanity unit	A bottle-trap is required when combining a hand-rinse washbasin with a vanity unit
B1, B3, B4, PN, RH, RK, VH, VJ				
	TALL CABINET	TALL CABINET	SIDE CABINET	SIDE CABINET
				
				
Article number	A894 00 XX	A894 01 XX	A895 00 XX	A895 01 XX
Dimensions (w x h x d)	350 x 1760 x 372 mm	350 x 1760 x 372 mm	350 x 890 x 373 mm	350 x 890 x 373 mm
Hinges	hinges on left	hinges on right	hinges on left	hinges on right
Equipped with	2x door 4x glass shelf	2x door 4x glass shelf	1x door 2x glass shelf	1x door 2x glass shelf
Installation	wall-mounted	wall-mounted	wall-mounted	wall-mounted
Scope of delivery	fastening set included	fastening set included	fastening set included	fastening set included
B1, B3, B4, PN, RH, RK, VH, VJ				

XX = Insert front and body colour
 B1 = Crystal Grey, B3 = Crystal Black, B4 = Crystal White, PN = Elm Impres-
 so, RH = Oak Kansas, RK = Stone Oak, VH = Arizona Oak, VJ = Nordic Oak

COLLARO

Sanitaryware and Bathroom Furniture

- Mainstream segment
- Matching furniture programme Collaro
- Selected washbasins also match the furniture programmes Finion, Legato
- Designed to match all mirror collections
- Designed to match all mirror cabinet collections
- matching wellness programme Collaro

PRO.VILLEROY-BOCH.COM/TECHNICALDRAWINGS



COLLARO

Ceramic colours



01 = White Alpin R1 = White Alpin CeramicPlus RW = Stone White CeramicPlus

Front- / Body colours



DH = Glossy White FP = Glossy Grey MS = White Matt PD = Black Matt Lacquer VG = Truffle Grey VK = Soft Grey E8 = White Wood RH = Oak Kansas RK = Stone Oak VH = Arizona Oak



VJ = Nordic Oak

COLLARO





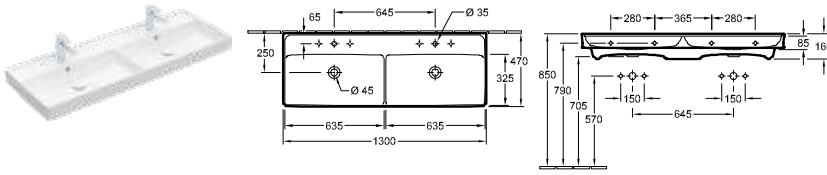

€ excl. VAT

Please order tap fittings and soap dispenser separately

DOUBLE VANITY WASHBASIN

Registered design



Article number	Description	01	plus R1	plus RW		pcs/ pal.	kg/ pc.
4A34 D4 XX	1300 x 470 mm 2x  				-	8	38
4A34 D1 XX	1300 x 470 mm 2x  				-	8	38



wall fixation, matching furniture programme: Collaro
 For further information about matching valves and CAP, see pages 380-383
 A non-closing valve or the ViFlow (concealed overflow) must be used for models without overflow function.

9221 49 00	WASHBASIN INSTALLATION ELEMENT 525 x 1120 x 75 mm For further ViConnect models, see pages 368-379		-	-	-	10	8,05
------------	--	---	---	---	---	----	------

DOUBLE VANITY WASHBASIN

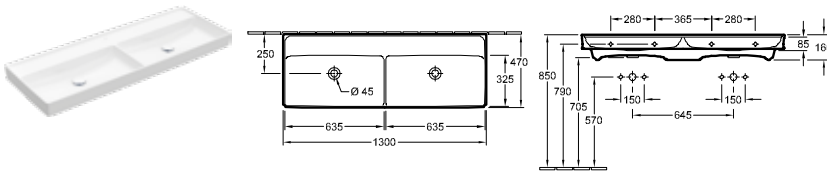
Registered design



Article number	Description	01	plus R1	plus RW		pcs/ pal.	kg/ pc.
4A34 D2 XX	1300 x 470 mm  				-	8	38





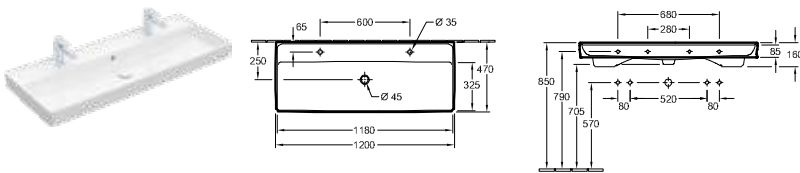

wall fixation, when using a wall-mounted tap fitting, we recommend a projection of at least 210 mm, matching furniture programme: Collaro
 For further information about matching valves and CAP, see pages 380-383
 Please note: unclosable outlet valve must be used with models without overflow

9221 49 00	WASHBASIN INSTALLATION ELEMENT 525 x 1120 x 75 mm For further ViConnect models, see pages 368-379		-	-	-	10	8,05
------------	--	---	---	---	---	----	------

VANITY WASHBASIN

Registered design



Article number	Description	01	plus R1	plus RW		pcs/ pal.	kg/ pc.
4A33 C4 XX	1200 x 470 mm 2x   with 2 single-lever mixers and turn-knob operation or in conjunction with toggle valve, as well as push-open valve, please do not exceed a flow rate of max. 7.5 l/min per tap fitting.				-	8	32,2
4A33 C1 XX	1200 x 470 mm 2x  				-	8	32,2

wall fixation, matching furniture programme: Collaro
 For further information about matching valves and CAP, see pages 380-383
 A non-closing valve or the ViFlow (concealed overflow) must be used for models without overflow function.

9221 49 00	WASHBASIN INSTALLATION ELEMENT 525 x 1120 x 75 mm For further ViConnect models, see pages 368-379		-	-	-	10	8,05
------------	--	---	---	---	---	----	------

XX = Colour code to be indicated
 01 = White Alpin, R1 = White Alpin CeramicPlus, RW = Stone White CeramicPlus

COLLARO





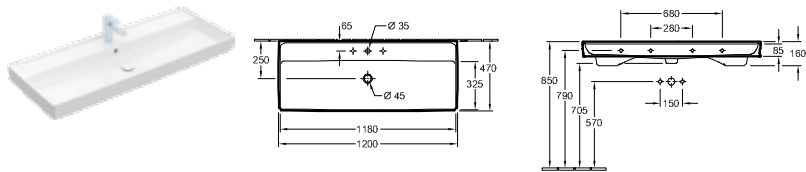

€ excl. VAT

Please order tap fittings and soap dispenser separately

VANITY WASHBASIN

Registered design



Article number	Description		01	plus R1	plus RW		pcs/ pal.	kg/ pc.
4A33 C5 XX	1200 x 470 mm  					-	8	32,2
4A33 C2 XX	1200 x 470 mm  					-	8	32,2

wall fixation, matching furniture programme: Collaro

For further information about matching valves and CAP, see pages 380-383



A non-closing valve or the ViFlow (concealed overflow) must be used for models without overflow function.

9221 49 00	WASHBASIN INSTALLATION ELEMENT 525 x 1120 x 75 mm For further ViConnect models, see pages 368-379		-	-	-		10	8,05
------------	--	---	---	---	---	--	----	------

VANITY WASHBASIN

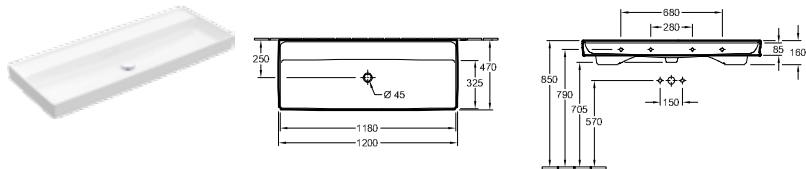
Registered design



Article number	Description		01	plus R1	plus RW		pcs/ pal.	kg/ pc.
4A33 C3 XX	1200 x 470 mm  					-	8	32,2

wall fixation, when using a wall-mounted tap fitting, we recommend a projection of at least 210 mm, matching furniture programme: Collaro

For further information about matching valves and CAP, see pages 380-383





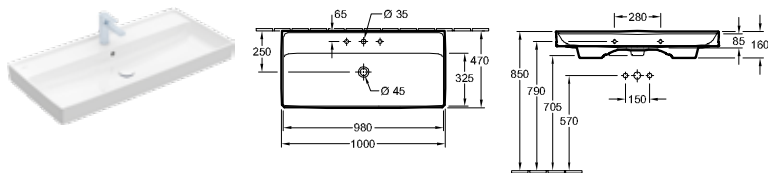

A non-closing valve or the ViFlow (concealed overflow) must be used for models without overflow function.

9221 49 00	WASHBASIN INSTALLATION ELEMENT 525 x 1120 x 75 mm For further ViConnect models, see pages 368-379		-	-	-		10	8,05
------------	--	---	---	---	---	--	----	------

VANITY WASHBASIN

Registered design



Article number	Description		01	plus R1	plus RW		pcs/ pal.	kg/ pc.
4A33 A5 XX	1000 x 470 mm  					-	8	26,7
4A33 A2 XX	1000 x 470 mm  					-	8	26,7

wall fixation, matching furniture programme: Collaro

For further information about matching valves and CAP, see pages 380-383

A non-closing valve or the ViFlow (concealed overflow) must be used for models without overflow function.

9221 49 00	WASHBASIN INSTALLATION ELEMENT 525 x 1120 x 75 mm For further ViConnect models, see pages 368-379		-	-	-		10	8,05
------------	--	---	---	---	---	--	----	------

XX = Colour code to be indicated

01 = White Alpin, R1 = White Alpin CeramicPlus, RW = Stone White CeramicPlus

COLLARO

COLLARO

€ excl. VAT

Please order tap fittings and soap dispenser separately

VANITY WASHBASIN

Registered design

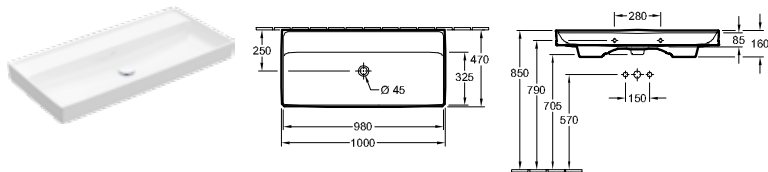

Article number	Description	01	plus R1	plus RW		pcs/ pal.	kg/ pc.
4A33 A3 XX	1000 x 470 mm					8	26,7

wall fixation, when using a wall-mounted tap fitting, we recommend a projection of at least 210 mm, matching furniture programme: Collaro

For further information about matching valves and CAP, see pages 380-383

A non-closing valve or the ViFlow (concealed overflow) must be used for models without overflow function.

9221 49 00	WASHBASIN INSTALLATION ELEMENT 525 x 1120 x 75 mm For further ViConnect models, see pages 368-379		-	-	-	10	8,05
------------	---	--	---	---	---	----	------

VANITY WASHBASIN

Registered design

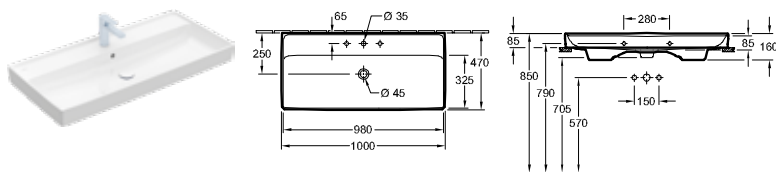

Article number	Description	01	plus R1	plus RW		pcs/ pal.	kg/ pc.
4A33 1G XX	1000 x 470 mm					8	26,3

ground underside, wall fixation, matching furniture programme: Collaro

For further information about matching valves and CAP, see pages 380-383

9221 49 00	WASHBASIN INSTALLATION ELEMENT 525 x 1120 x 75 mm For further ViConnect models, see pages 368-379		-	-	-	10	8,05
------------	---	--	---	---	---	----	------

VANITY WASHBASIN

Registered design

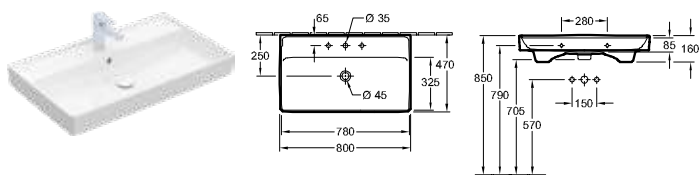

Article number	Description	01	plus R1	plus RW		pcs/ pal.	kg/ pc.
4A33 80 XX	800 x 470 mm					12	21
4A33 81 XX	800 x 470 mm					12	21

wall fixation, matching furniture programme: Collaro

For further information about matching valves and CAP, see pages 380-383

A non-closing valve or the ViFlow (concealed overflow) must be used for models without overflow function.

9221 49 00	WASHBASIN INSTALLATION ELEMENT 525 x 1120 x 75 mm For further ViConnect models, see pages 368-379		-	-	-	10	8,05
------------	---	--	---	---	---	----	------

XX = Colour code to be indicated

01 = White Alpin, R1 = White Alpin CeramicPlus, RW = Stone White CeramicPlus

COLLARO

€ excl. VAT

Please order tap fittings and soap dispenser separately

VANITY WASHBASIN

Registered design

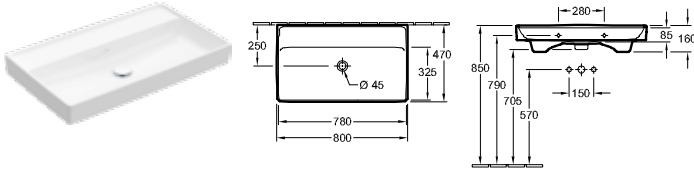

Article number	Description	01	plus R1	plus RW		pcs/ pal.	kg/ pc.
4A33 83 XX	800 x 470 mm				-	12	21

wall fixation, when using a wall-mounted tap fitting, we recommend a projection of at least 210 mm, matching furniture programme: Collaro

For further information about matching valves and CAP, see pages 380-383

A non-closing valve or the ViFlow (concealed overflow) must be used for models without overflow function.

9221 49 00	WASHBASIN INSTALLATION ELEMENT 525 x 1120 x 75 mm For further ViConnect models, see pages 368-379		-	-	-	10	8,05
------------	---	--	---	---	---	----	------

VANITY WASHBASIN

Registered design

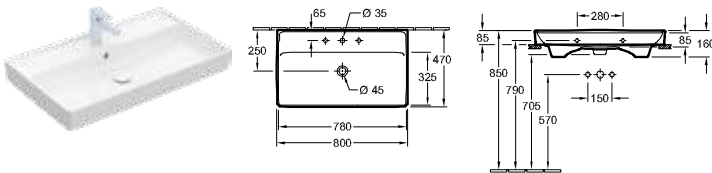

Article number	Description	01	plus R1	plus RW		pcs/ pal.	kg/ pc.
4A33 8G XX	800 x 470 mm				-	12	21

ground underside, wall fixation, matching furniture programme: Collaro

For further information about matching valves and CAP, see pages 380-383

9221 49 00	WASHBASIN INSTALLATION ELEMENT 525 x 1120 x 75 mm For further ViConnect models, see pages 368-379		-	-	-	10	8,05
------------	---	--	---	---	---	----	------

WASHBASINS

Registered design

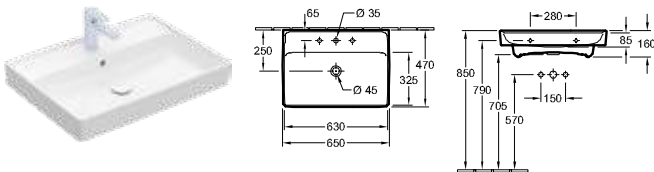

Article number	Description	01	plus R1	plus RW		pcs/ pal.	kg/ pc.
4A33 65 XX	650 x 470 mm				-	16	19,2
4A33 66 XX	650 x 470 mm				-	16	19,2
4A33 68 XX	650 x 470 mm when using a wall-mounted tap fitting, we recommend a projection of at least 210 mm				-	16	19,2

wall fixation, matching furniture programme: Collaro

For further information about matching valves and CAP, see pages 380-383

A non-closing valve or the ViFlow (concealed overflow) must be used for models without overflow function.

9221 49 00	WASHBASIN INSTALLATION ELEMENT 525 x 1120 x 75 mm For further ViConnect models, see pages 368-379		-	-	-	10	8,05
------------	---	--	---	---	---	----	------

XX = Colour code to be indicated

01 = White Alpin, R1 = White Alpin CeramicPlus, RW = Stone White CeramicPlus

COLLARO







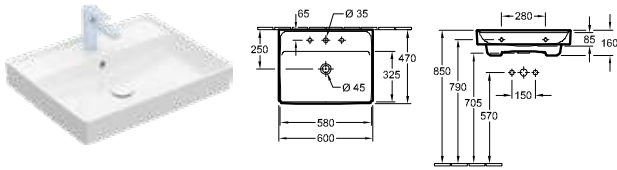

€ excl. VAT

Please order tap fittings and soap dispenser separately

WASHBASINS

Registered design



Article number	Description		01	plus R1	plus RW		pcs/ pal.	kg/ pc.
4A33 60 XX	600 x 470 mm  					-	18	17,4
4A33 61 XX	600 x 470 mm  					-	18	17,4
4A33 63 XX	600 x 470 mm   when using a wall-mounted tap fitting, we recommend a projection of at least 210 mm					-	18	17,4

wall fixation, matching furniture programme: Collaro

For further information about matching valves and CAP, see pages 380-383



A non-closing valve or the ViFlow (concealed overflow) must be used for models without overflow function.

9221 49 00	WASHBASIN INSTALLATION ELEMENT 525 x 1120 x 75 mm For further ViConnect models, see pages 368-379		-	-	-		10	8,05
------------	--	---	---	---	---	--	----	------

WASHBASINS

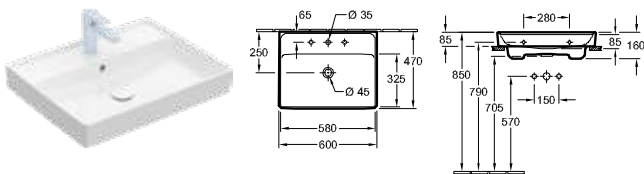
Registered design



Article number	Description		01	plus R1	plus RW		pcs/ pal.	kg/ pc.
4A33 6G XX	600 x 470 mm  					-	10	17,4

ground underside, wall fixation, matching furniture programme: Collaro

For further information about matching valves and CAP, see pages 380-383

9221 49 00	WASHBASIN INSTALLATION ELEMENT 525 x 1120 x 75 mm For further ViConnect models, see pages 368-379		-	-	-		10	8,05
------------	--	---	---	---	---	--	----	------

XX = Colour code to be indicated

01 = White Alpin, R1 = White Alpin CeramicPlus, RW = Stone White CeramicPlus

COLLARO

€ excl. VAT

Please order tap fittings and soap dispenser separately

WASHBASINS

Registered design

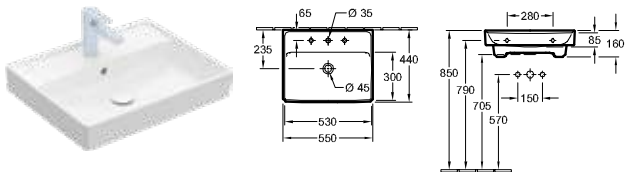

Article number	Description		01	plus R1	plus RW		pcs/ pal.	kg/ pc.
4A33 55 XX	550 x 440 mm					-	18	16,4
4A33 56 XX	550 x 440 mm					-	18	16,4
4A33 58 XX	550 x 440 mm when using a wall-mounted tap fitting, we recommend a projection of at least 210 mm					-	18	16,4

wall fixation, matching furniture programme: Collaro

For further information about matching valves and CAP, see pages 380-383

A non-closing valve or the ViFlow (concealed overflow) must be used for models without overflow function.

9221 49 00	WASHBASIN INSTALLATION ELEMENT 525 x 1120 x 75 mm For further ViConnect models, see pages 368-379		-	-	-		10	8,05
------------	--	--	---	---	---	--	----	------

HANDWASHBASIN

Registered design

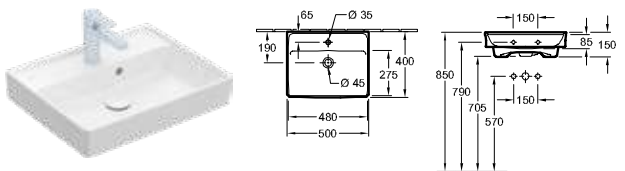

Article number	Description		01	plus R1	plus RW		pcs/ pal.	kg/ pc.
4334 50 XX	500 x 400 mm					-	24	13,3
4334 51 XX	500 x 400 mm					-	24	13,3

wall fixation, matching furniture programme: Collaro

For further information about matching valves and CAP, see pages 380-383

A non-closing valve or the ViFlow (concealed overflow) must be used for models without overflow function.

9221 49 00	WASHBASIN INSTALLATION ELEMENT 525 x 1120 x 75 mm For further ViConnect models, see pages 368-379		-	-	-		10	8,05
------------	--	--	---	---	---	--	----	------

HANDWASHBASIN

Registered design

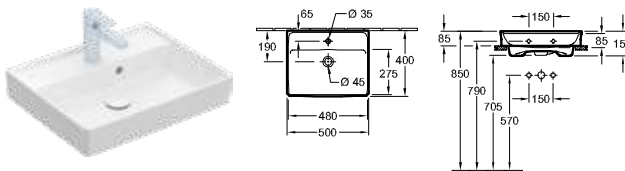

Article number	Description		01	plus R1	plus RW		pcs/ pal.	kg/ pc.
4334 5G XX	500 x 400 mm					-	16	13,3

ground underside, wall fixation, matching furniture programme: Collaro

For further information about matching valves and CAP, see pages 380-383

9221 49 00	WASHBASIN INSTALLATION ELEMENT 525 x 1120 x 75 mm For further ViConnect models, see pages 368-379		-	-	-		10	8,05
------------	--	--	---	---	---	--	----	------

XX = Colour code to be indicated

01 = White Alpin, R1 = White Alpin CeramicPlus, RW = Stone White CeramicPlus

COLLARO

COLLARO





€ excl. VAT

Please order tap fittings and soap dispenser separately

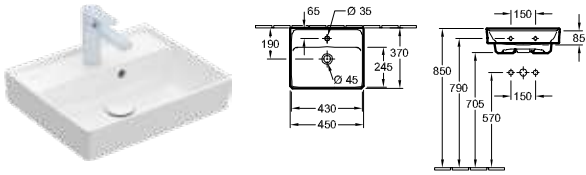
HANDWASHBASIN

Registered design





Article number	Description	01	plus R1	plus RW		pcs/ pal.	kg/ pc.
4334 45 XX	450 x 370 mm 				-	36	11,2
4334 46 XX	450 x 370 mm 				-	36	11,2

wall fixation, matching furniture programme: Collaro
 For further information about matching valves and CAP, see pages 380-383
 A non-closing valve or the ViFlow (concealed overflow) must be used for models without overflow function.

9221 49 00	WASHBASIN INSTALLATION ELEMENT 525 x 1120 x 75 mm For further ViConnect models, see pages 368-379		-	-	-	10	8,05
------------	---	---	---	---	---	----	------

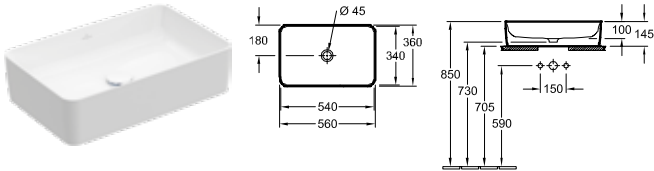
SURFACE-MOUNTED WASHBASIN





Article number	Description	01	plus R1	plus RW		pcs/ pal.	kg/ pc.
4A20 56 XX	560 x 360 mm for wall-mounted washbasin mixers or tall pillar tap fittings, without tap hole area 				-	10	14,5

Recommendation: to be installed with a gap of at least 50 mm between the washbasin and the wall, incl. template, fastening set included, when using a wall-mounted tap fitting, we recommend a projection of at least 210 mm, matching furniture programme: Collaro, Legato, Finion
 For further information about matching valves and CAP, see pages 380-383
 Please note: unclosable outlet valve must be used with models without overflow

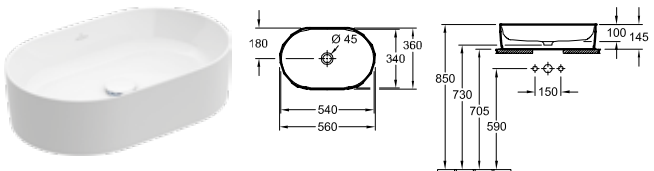
SURFACE-MOUNTED WASHBASIN



Article number	Description	01	plus R1	plus RW		pcs/ pal.	kg/ pc.
4A19 56 XX	560 x 360 mm for wall-mounted washbasin mixers or tall pillar tap fittings, without tap hole area 				-	16	11,7

Recommendation: to be installed with a gap of at least 50 mm between the washbasin and the wall, incl. template, fastening set included, when using a wall-mounted tap fitting, we recommend a projection of at least 210 mm, matching furniture programme: Collaro, Legato, Finion
 For further information about matching valves and CAP, see pages 380-383
 Please note: unclosable outlet valve must be used with models without overflow

XX = Colour code to be indicated
 01 = White Alpin, R1 = White Alpin CeramicPlus, RW = Stone White CeramicPlus

COLLARO

€ excl. VAT

Please order tap fittings and soap dispenser separately

SURFACE-MOUNTED WASHBASIN

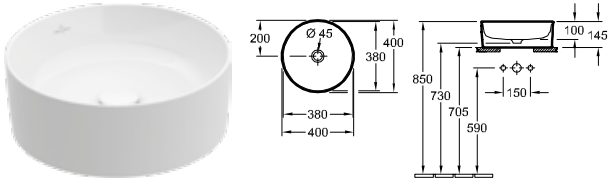

Article number	Description	01	plus R1	plus RW		pcs/ pal.	kg/ pc.
4A18 40 XX	400 mm Diameter for wall-mounted washbasin mixers or tall pillar tap fittings, without tap hole area  Titan Ceram				-	30	9,3

Recommendation: to be installed with a gap of at least 50 mm between the washbasin and the wall, incl. template, fastening set included, when using a wall-mounted tap fitting, we recommend a projection of at least 210 mm, matching furniture programme: Collaro, Legato, Finion

For further information about matching valves and CAP, see pages 380-383

Please note: unclosable outlet valve must be used with models without overflow

SURFACE-MOUNTED WASHBASIN

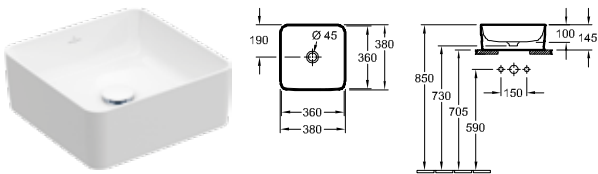

Article number	Description	01	plus R1	plus RW		pcs/ pal.	kg/ pc.
4A21 38 XX	380 x 380 mm for wall-mounted washbasin mixers or tall pillar tap fittings, without tap hole area  Titan Ceram				-	30	10,8

Recommendation: to be installed with a gap of at least 50 mm between the washbasin and the wall, incl. template, fastening set included, when using a wall-mounted tap fitting, we recommend a projection of at least 210 mm, matching furniture programme: Collaro, Legato, Finion



For further information about matching valves and CAP, see pages 380-383

Please note: unclosable outlet valve must be used with models without overflow

SURFACE-MOUNTED WASHBASIN

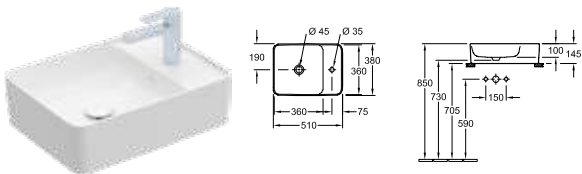
Registered design



Article number	Description	01	plus R1	plus RW		pcs/ pal.	kg/ pc.
4A17 51 XX	510 x 380 mm  Titan Ceram				-	16	14,2
4A17 53 XX	510 x 380 mm for wall outlet tap fitting or tap fitting with raised base, with tap hole surface, tap hole not punched through  Titan Ceram				-	16	14,2

reversible, incl. template, fastening set included, matching furniture programme: Collaro, Legato

For further information about matching valves and CAP, see pages 380-383

Please note: unclosable outlet valve must be used with models without overflow

XX = Colour code to be indicated

01 = White Alpin, R1 = White Alpin CeramicPlus, RW = Stone White CeramicPlus

COLLARO

€ excl. VAT

Please order tap fittings and soap dispenser separately

SURFACE-MOUNTED WASHBASIN

Registered design

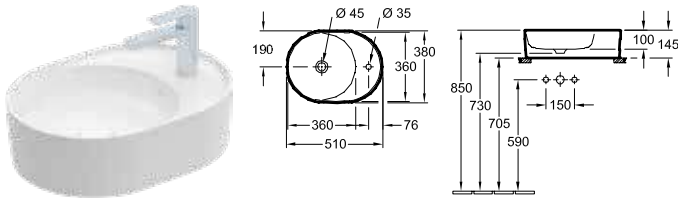

Article number	Description	01	plus R1	plus RW		pcs/ pal.	kg/ pc.
4A15 51 XX	510 x 380 mm				-	16	11,4
4A15 53 XX	510 x 380 mm for wall outlet tap fitting or tap fitting with raised base, with tap hole surface, tap hole not punched through				-	16	11,4

reversible, incl. template, fastening set included, matching furniture programme: Collaro, Legato

For further information about matching valves and CAP, see pages 380-383

Please note: unclosable outlet valve must be used with models without overflow

COMBI-PACK

TwistFlush

We recommend the SUBWAY 3.0 combi-pack for COLLARO

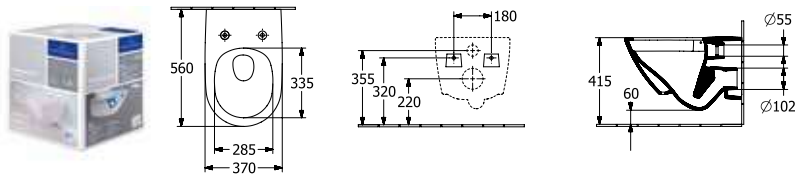

Article number	Description	01	plus R1	plus RW		pcs/ pal.	kg/ pc.
4670 TS XX	individual packaging materials, wall-mounted, horizontal outlet composed of: Washdown WC TwistFlush 4670 T0 XX, WC-seat and cover with Quick-Release and SoftClosing hinges 8M42 S1 01				-	12	25,6



XX = Colour code to be indicated

01 = White Alpin, R1 = White Alpin CeramicPlus, RW = Stone White CeramicPlus

COLLARO

€ excl. VAT

Produced to order (Please note that it is not always possible to cancel or change orders!), The washbasins are to be ordered separately.

Front:
 MDF with acrylic film in DH, FP (16 mm)
 direct-laminated chipboard in E8, MS, RH, RK, VG, VH, VJ, VK (16 mm)
 painted MDF in PD (16 mm)
 horizontal grain in E8, RH, RK, VH, VJ
 matching interior colour for DH, FP
 interior colour to match décor for E8, MS, RH, RK, VG, VH, VJ, VK
 interior colour Anthracite for PD

Body:
 MDF with acrylic film in DH, FP (8 mm)
 direct-laminated chipboard in E8, MS, RH, RK, VG, VH, VJ, VK (8 mm)
 painted MDF in PD (8 mm)
 horizontal grain in E8, RH, RK, VH, VJ

Interior body:
 direct-laminated chipboard in anthracite

Washbasin countertop:
 painted MDF in DH, FP, PD (8 mm)
 direct-laminated chipboard in E8, MS, RH, RK, VG, VH, VJ, VK (8 mm)

Drawers:
 Slip-resistant base
 SoftClosing feature

Doors:
 SoftClosing feature

Handles:
 handle in lacquered Aluminium

Interior compartments :
 adjustable glass partitions (8 mm)
 accessory boxes made of grey translucent plastic

Lighting:
 integrated LED lighting
 continuously dimmable
 freely-adjustable light colour from DaylightWhite (6500 kelvin) to WarmWhite (2700 kelvin)
 With remote control
 Memory feature - The lighting readjusts to the intensity and colour temperature that were set before the power was switched off.
 loose mains connection

Colour combinations of furniture finish and handle:
 Furniture finish in VG combined with handle strip in Truffle Grey
 Furniture finish in PD combined with handle strip in Black Matt
 Furniture finish in VK, VJ combined with handle strip in Soft Grey
 Furniture finish in DH, E8, MS combined with handle strip in White Matt
 Furniture finish in FP, VH combined with handle strip in Anthracite Matt
 Furniture finish in RH, RK combined with handle strip in Anthracite Matt

Please note:
 A control unit is needed to operate the lighting in the furniture and mirror. This is not included in the scope of delivery and must be ordered separately under the following article number: G999 02 00. Only one control unit is required per bathroom.
 For further information such as tap fitting positions, installation and fastening dimensions etc. please see the technical drawings.
 The washbasin clippings shown are representative of all washbasin combination options.





	HANDLE STRIP	HANDLE STRIP	HANDLE STRIP	HANDLE STRIP
				
Colour	handle strip Truffle Grey	handle strip Black Matt	handle strip Soft Grey	handle strip White Matt
	HANDLE STRIP			
				
Colour	handle strip Anthracite Matt			
	ACCESSORIES PACKAGE 1			
Equipped with	1x wide glass drawer divider 2x narrow glass drawer divider 1x accessory box L			





XX = Insert front and body colour
 DH = Glossy White, FP = Glossy Grey, MS = White Matt, PD = Black Matt
 Lacquer, VG = Truffle Grey, VK = Soft Grey, E8 = White Wood, RH = Oak
 Kansas, RK = Stone Oak, VH = Arizona Oak, VJ = Nordic Oak

COLLARO

€ excl. VAT

Produced to order (Please note that it is not always possible to cancel or change orders!), The washbasins are to be ordered separately.

	VANITY UNIT	VANITY UNIT	VANITY UNIT	VANITY UNIT
				
Article number	C013 00 XX	C013 L0 XX	C012 00 XX	C012 L0 XX
Dimensions (w x h x d)	1254 x 546 x 444 mm	1254 x 546 x 444 mm	1154 x 546 x 444 mm	1154 x 546 x 444 mm
Version	washbasin on the middle	washbasin on the middle	washbasin on the middle	washbasin on the middle
For combination with	Collaro 4A34 D1/D2/D4	Collaro 4A34 D1/D2/D4	Collaro 4A33 C1/C2/C3/C5	Collaro 4A33 C1/C2/C3/C5
Lighting	-	LED lighting Lighting 1x LED / 9,2 W	-	LED lighting Lighting 1x LED / 8,5 W
Equipped with	2x Accessories package 1 4x pull-out compartment with non-slip mat	2x Accessories package 1 4x pull-out compartment with non-slip mat	2x Accessories package 1 4x pull-out compartment with non-slip mat	2x Accessories package 1 4x pull-out compartment with non-slip mat
Installation	wall-mounted	wall-mounted	wall-mounted	wall-mounted
Scope of delivery	fastening set included	fastening set included	fastening set included	fastening set included
Please note	-	-	vanity washbasin 4A33 C4 only available in combination with a push-open valve	vanity washbasin 4A33 C4 only available in combination with a push-open valve
DH, E8, FP, MS, RH, RK, VG, VH, VJ, VK				
PD				









	VANITY UNIT	VANITY UNIT	VANITY UNIT	VANITY UNIT
				
Article number	C011 00 XX	C011 L0 XX	C010 00 XX	C010 L0 XX
Dimensions (w x h x d)	954 x 546 x 444 mm	954 x 546 x 444 mm	754 x 546 x 444 mm	754 x 546 x 444 mm
Version	washbasin on the middle	washbasin on the middle	washbasin on the middle	washbasin on the middle
For combination with	Collaro 4A33 A2/A3/A5	Collaro 4A33 A2/A3/A5	Collaro 4A33 80/81/83	Collaro 4A33 80/81/83
Lighting	-	LED lighting Lighting 1x LED / 6,9 W	-	LED lighting Lighting 1x LED / 5,4 W
Equipped with	1x Accessories package 1 2x pull-out compartment with non-slip mat	1x Accessories package 1 2x pull-out compartment with non-slip mat	1x Accessories package 1 2x pull-out compartment with non-slip mat	1x Accessories package 1 2x pull-out compartment with non-slip mat
Installation	wall-mounted	wall-mounted	wall-mounted	wall-mounted
Scope of delivery	fastening set included	fastening set included	fastening set included	fastening set included
DH, E8, FP, MS, RH, RK, VG, VH, VJ, VK				
PD				

XX = Insert front and body colour
 DH = Glossy White, FP = Glossy Grey, MS = White Matt, PD = Black Matt
 Lacquer, VG = Truffle Grey, VK = Soft Grey, E8 = White Wood, RH = Oak
 Kansas, RK = Stone Oak, VH = Arizona Oak, VJ = Nordic Oak

COLLARO

€ excl. VAT

Produced to order (Please note that it is not always possible to cancel or change orders!), The washbasins are to be ordered separately.

	VANITY UNIT	VANITY UNIT	VANITY UNIT	VANITY UNIT
				
Article number	C009 00 XX	C009 L0 XX	C008 00 XX	C008 L0 XX
Dimensions (w x h x d)	604 x 546 x 444 mm	604 x 546 x 444 mm	554 x 546 x 444 mm	554 x 546 x 444 mm
Version	washbasin on the middle	washbasin on the middle	washbasin on the middle	washbasin on the middle
For combination with	Collaro 4A33 65/66/68	Collaro 4A33 65/66/68	Collaro 4A33 60/61/63	Collaro 4A33 60/61/63
Lighting	-	LED lighting Lighting 1x LED / 4,2 W	-	LED lighting Lighting 1x LED / 3,9 W
Equipped with	1x Accessories package 1 2x pull-out compartment with non-slip mat	1x Accessories package 1 2x pull-out compartment with non-slip mat	1x Accessories package 1 2x pull-out compartment with non-slip mat	1x Accessories package 1 2x pull-out compartment with non-slip mat
Installation	wall-mounted	wall-mounted	wall-mounted	wall-mounted
Scope of delivery	fastening set included	fastening set included	fastening set included	fastening set included
DH, E8, FP, MS, RH, RK, VG, VH, VJ, VK				
PD				
	VANITY UNIT	VANITY UNIT	VANITY UNIT	VANITY UNIT
				
Article number	C007 00 XX	C007 L0 XX	C006 00 XX	C006 L0 XX
Dimensions (w x h x d)	510 x 546 x 414 mm	510 x 546 x 414 mm	460 x 546 x 374 mm	460 x 546 x 374 mm
Version	washbasin on the middle	washbasin on the middle	washbasin on the middle	washbasin on the middle
For combination with	Collaro 4A33 55/56/58	Collaro 4A33 55/56/58	Collaro 4334 50/51	Collaro 4334 50/51
Lighting	-	LED lighting Lighting 1x LED / 3,5 W	-	LED lighting Lighting 1x LED / 3,1 W
Equipped with	1x accessory box L 2x pull-out compartment with non-slip mat	1x accessory box L 2x pull-out compartment with non-slip mat	1x accessory box L 2x pull-out compartment with non-slip mat	1x accessory box L 2x pull-out compartment with non-slip mat
Installation	wall-mounted	wall-mounted	wall-mounted	wall-mounted
Scope of delivery	fastening set included	fastening set included	fastening set included	fastening set included
DH, E8, FP, MS, RH, RK, VG, VH, VJ, VK				
PD				

COLLARO



XX = Insert front and body colour
 DH = Glossy White, FP = Glossy Grey, MS = White Matt, PD = Black Matt
 Lacquer, VG = Truffle Grey, VK = Soft Grey, E8 = White Wood, RH = Oak
 Kansas, RK = Stone Oak, VH = Arizona Oak, VJ = Nordic Oak

COLLARO

€ excl. VAT

Produced to order (Please note that it is not always possible to cancel or change orders!), The washbasins are to be ordered separately.

	VANITY UNIT	VANITY UNIT
		
Article number	C005 00 XX	C005 01 XX
Dimensions (w x h x d)	410 x 546 x 344 mm	410 x 546 x 344 mm
Version	washbasin on the middle	washbasin on the middle
Hinges	hinges on left	hinges on right
For combination with	Collaro 4334 45/46	Collaro 4334 45/46
Equipped with	1x door 1x shelf	1x door 1x shelf
Installation	wall-mounted	wall-mounted
Scope of delivery	fastening set included	fastening set included
DH, E8, FP, MS, RH, RK, VG, VH, VJ, VK		
PD		

	VANITY UNIT	VANITY UNIT	VANITY UNIT	VANITY UNIT
				
Article number	C031 00 XX	C031 L0 XX	C029 00 XX	C029 L0 XX
Dimensions (w x h x d)	1600 x 548 x 500 mm	1600 x 548 x 500 mm	1600 x 548 x 500 mm	1600 x 548 x 500 mm
Version	washbasin on the middle	washbasin on the middle	washbasin on left	washbasin on left
For combination with	Collaro 4A33 1G	Collaro 4A33 1G	Collaro 4A33 1G	Collaro 4A33 1G
Lighting	-	LED lighting Lighting 1x LED / 11,9 W	-	LED lighting Lighting 1x LED / 11,9 W
Equipped with	2x Accessories package 1 4x pull-out compartment with non-slip mat	2x Accessories package 1 4x pull-out compartment with non-slip mat	2x Accessories package 1 4x pull-out compartment with non-slip mat	2x Accessories package 1 4x pull-out compartment with non-slip mat
Installation	wall-mounted	wall-mounted	wall-mounted	wall-mounted
Scope of delivery	fastening set included	fastening set included	fastening set included	fastening set included
DH, E8, FP, MS, RH, RK, VG, VH, VJ, VK				
PD				

XX = Insert front and body colour
 DH = Glossy White, FP = Glossy Grey, MS = White Matt, PD = Black Matt
 Lacquer, VG = Truffle Grey, VK = Soft Grey, E8 = White Wood, RH = Oak
 Kansas, RK = Stone Oak, VH = Arizona Oak, VJ = Nordic Oak

COLLARO

€ excl. VAT

Produced to order (Please note that it is not always possible to cancel or change orders!), The washbasins are to be ordered separately.

	VANITY UNIT	VANITY UNIT	VANITY UNIT	VANITY UNIT
				
Article number	C030 00 XX	C030 L0 XX	C028 00 XX	C028 L0 XX
Dimensions (w x h x d)	1600 x 548 x 500 mm	1600 x 548 x 500 mm	1600 x 548 x 500 mm	1600 x 548 x 500 mm
Version	washbasin on right	washbasin on right	washbasin on the middle	washbasin on the middle
For combination with	Collaro 4A33 1G	Collaro 4A33 1G	Collaro 4A33 8G	Collaro 4A33 8G
Lighting	-	LED lighting Lighting 1x LED / 11,9 W	-	LED lighting Lighting 1x LED / 11,9 W
Equipped with	2x Accessories package 1 4x pull-out compartment with non-slip mat	2x Accessories package 1 4x pull-out compartment with non-slip mat	2x Accessories package 1 4x pull-out compartment with non-slip mat	2x Accessories package 1 4x pull-out compartment with non-slip mat
Installation	wall-mounted	wall-mounted	wall-mounted	wall-mounted
Scope of delivery	fastening set included	fastening set included	fastening set included	fastening set included
DH, E8, FP, MS, RH, RK, VG, VH, VJ, VK				
PD				
	VANITY UNIT	VANITY UNIT	VANITY UNIT	VANITY UNIT
				
Article number	C026 00 XX	C026 L0 XX	C027 00 XX	C027 L0 XX
Dimensions (w x h x d)	1600 x 548 x 500 mm	1600 x 548 x 500 mm	1600 x 548 x 500 mm	1600 x 548 x 500 mm
Version	washbasin on left	washbasin on left	washbasin on right	washbasin on right
For combination with	Collaro 4A33 8G	Collaro 4A33 8G	Collaro 4A33 8G	Collaro 4A33 8G
Lighting	-	LED lighting Lighting 1x LED / 11,9 W	-	LED lighting Lighting 1x LED / 11,9 W
Equipped with	2x Accessories package 1 4x pull-out compartment with non-slip mat	2x Accessories package 1 4x pull-out compartment with non-slip mat	2x Accessories package 1 4x pull-out compartment with non-slip mat	2x Accessories package 1 4x pull-out compartment with non-slip mat
Installation	wall-mounted	wall-mounted	wall-mounted	wall-mounted
Scope of delivery	fastening set included	fastening set included	fastening set included	fastening set included
DH, E8, FP, MS, RH, RK, VG, VH, VJ, VK				
PD				

COLLARO

XX = Insert front and body colour
 DH = Glossy White, FP = Glossy Grey, MS = White Matt, PD = Black Matt
 Lacquer, VG = Truffle Grey, VK = Soft Grey, E8 = White Wood, RH = Oak
 Kansas, RK = Stone Oak, VH = Arizona Oak, VJ = Nordic Oak

COLLARO

€ excl. VAT

Produced to order (Please note that it is not always possible to cancel or change orders!), The washbasins are to be ordered separately.

	VANITY UNIT	VANITY UNIT	VANITY UNIT	VANITY UNIT
				
Article number	C024 00 XX	C024 L0 XX	C025 00 XX	C025 L0 XX
Dimensions (w x h x d)	1600 x 548 x 500 mm	1600 x 548 x 500 mm	1600 x 548 x 500 mm	1600 x 548 x 500 mm
Version	for 2 washbasins	for 2 washbasins	washbasin on the middle	washbasin on the middle
For combination with	Collaro 4A33 6G	Collaro 4A33 6G	Collaro 4A33 6G	Collaro 4A33 6G
Lighting	-	LED lighting Lighting 1x LED / 11,9 W	-	LED lighting Lighting 1x LED / 11,9 W
Equipped with	2x Accessories package 1 4x pull-out compartment with non-slip mat	2x Accessories package 1 4x pull-out compartment with non-slip mat	2x Accessories package 1 4x pull-out compartment with non-slip mat	2x Accessories package 1 4x pull-out compartment with non-slip mat
Installation	wall-mounted	wall-mounted	wall-mounted	wall-mounted
Scope of delivery	fastening set included	fastening set included	fastening set included	fastening set included
DH, E8, FP, MS, RH, RK, VG, VH, VJ, VK				
PD				
	VANITY UNIT	VANITY UNIT	VANITY UNIT	VANITY UNIT
				
Article number	C022 00 XX	C022 L0 XX	C023 00 XX	C023 L0 XX
Dimensions (w x h x d)	1600 x 548 x 500 mm	1600 x 548 x 500 mm	1600 x 548 x 500 mm	1600 x 548 x 500 mm
Version	washbasin on left	washbasin on left	washbasin on right	washbasin on right
For combination with	Collaro 4A33 6G	Collaro 4A33 6G	Collaro 4A33 6G	Collaro 4A33 6G
Lighting	-	LED lighting Lighting 1x LED / 11,9 W	-	LED lighting Lighting 1x LED / 11,9 W
Equipped with	2x Accessories package 1 4x pull-out compartment with non-slip mat	2x Accessories package 1 4x pull-out compartment with non-slip mat	2x Accessories package 1 4x pull-out compartment with non-slip mat	2x Accessories package 1 4x pull-out compartment with non-slip mat
Installation	wall-mounted	wall-mounted	wall-mounted	wall-mounted
Scope of delivery	fastening set included	fastening set included	fastening set included	fastening set included
DH, E8, FP, MS, RH, RK, VG, VH, VJ, VK				
PD				









COLLARO

XX = Insert front and body colour
 DH = Glossy White, FP = Glossy Grey, MS = White Matt, PD = Black Matt
 Lacquer, VG = Truffle Grey, VK = Soft Grey, E8 = White Wood, RH = Oak
 Kansas, RK = Stone Oak, VH = Arizona Oak, VJ = Nordic Oak

COLLARO

€ excl. VAT

Produced to order (Please note that it is not always possible to cancel or change orders!), The washbasins are to be ordered separately.

	VANITY UNIT	VANITY UNIT	VANITY UNIT	VANITY UNIT
				
Article number	C021 00 XX	C021 L0 XX	C020 00 XX	C020 L0 XX
Dimensions (w x h x d)	1600 x 548 x 500 mm	1600 x 548 x 500 mm	1000 x 548 x 500 mm	1000 x 548 x 500 mm
Version	for 2 washbasins	for 2 washbasins	washbasin on the middle	washbasin on the middle
For combination with	Collaro 4334 5G	Collaro 4334 5G	Collaro 4A33 8G	Collaro 4A33 8G
Lighting	-	LED lighting Lighting 1x LED / 11,9 W	-	LED lighting Lighting 1x LED / 7,2 W
Equipped with	2x Accessories package 1 4x pull-out compartment with non-slip mat	2x Accessories package 1 4x pull-out compartment with non-slip mat	1x Accessories package 1 2x pull-out compartment with non-slip mat	1x Accessories package 1 2x pull-out compartment with non-slip mat
Installation	wall-mounted	wall-mounted	wall-mounted	wall-mounted
Scope of delivery	fastening set included	fastening set included	fastening set included	fastening set included
DH, E8, FP, MS, RH, RK, VG, VH, VJ, VK				
PD				
	VANITY UNIT	VANITY UNIT	VANITY UNIT	VANITY UNIT
				
Article number	C019 00 XX	C019 L0 XX	C017 00 XX	C017 L0 XX
Dimensions (w x h x d)	1000 x 548 x 500 mm	1000 x 548 x 500 mm	1000 x 548 x 500 mm	1000 x 548 x 500 mm
Version	washbasin on the middle	washbasin on the middle	washbasin on left	washbasin on left
For combination with	Collaro 4A33 6G	Collaro 4A33 6G	Collaro 4A33 6G	Collaro 4A33 6G
Lighting	-	LED lighting Lighting 1x LED / 7,2 W	-	LED lighting Lighting 1x LED / 7,2 W
Equipped with	1x Accessories package 1 2x pull-out compartment with non-slip mat	1x Accessories package 1 2x pull-out compartment with non-slip mat	1x Accessories package 1 2x pull-out compartment with non-slip mat	1x Accessories package 1 2x pull-out compartment with non-slip mat
Installation	wall-mounted	wall-mounted	wall-mounted	wall-mounted
Scope of delivery	fastening set included	fastening set included	fastening set included	fastening set included
DH, E8, FP, MS, RH, RK, VG, VH, VJ, VK				
PD				









COLLARO

XX = Insert front and body colour
 DH = Glossy White, FP = Glossy Grey, MS = White Matt, PD = Black Matt
 Lacquer, VG = Truffle Grey, VK = Soft Grey, E8 = White Wood, RH = Oak
 Kansas, RK = Stone Oak, VH = Arizona Oak, VJ = Nordic Oak

COLLARO

€ excl. VAT

Produced to order (Please note that it is not always possible to cancel or change orders!), The washbasins are to be ordered separately.



	VANITY UNIT	VANITY UNIT	VANITY UNIT	VANITY UNIT
				
Article number	C018 00 XX	C018 L0 XX	C016 00 XX	C016 L0 XX
Dimensions (w x h x d)	1000 x 548 x 500 mm	1000 x 548 x 500 mm	1000 x 548 x 500 mm	1000 x 548 x 500 mm
Version	washbasin on right	washbasin on right	washbasin on the middle	washbasin on the middle
For combination with	Collaro 4A33 6G	Collaro 4A33 6G	Collaro 4334 5G	Collaro 4334 5G
Lighting	-	LED lighting Lighting 1x LED / 7,2 W	-	LED lighting Lighting 1x LED / 7,2 W
Equipped with	1x Accessories package 1 2x pull-out compartment with non-slip mat	1x Accessories package 1 2x pull-out compartment with non-slip mat	1x Accessories package 1 2x pull-out compartment with non-slip mat	1x Accessories package 1 2x pull-out compartment with non-slip mat
Installation	wall-mounted	wall-mounted	wall-mounted	wall-mounted
Scope of delivery	fastening set included	fastening set included	fastening set included	fastening set included
DH, E8, FP, MS, RH, RK, VG, VH, VJ, VK				
PD				
	VANITY UNIT	VANITY UNIT	VANITY UNIT	VANITY UNIT
				
Article number	C014 00 XX	C014 L0 XX	C015 00 XX	C015 L0 XX
Dimensions (w x h x d)	1000 x 548 x 500 mm	1000 x 548 x 500 mm	1000 x 548 x 500 mm	1000 x 548 x 500 mm
Version	washbasin on left	washbasin on left	washbasin on right	washbasin on right
For combination with	Collaro 4334 5G	Collaro 4334 5G	Collaro 4334 5G	Collaro 4334 5G
Lighting	-	LED lighting Lighting 1x LED / 7,2 W	-	LED lighting Lighting 1x LED / 7,2 W
Equipped with	1x Accessories package 1 2x pull-out compartment with non-slip mat	1x Accessories package 1 2x pull-out compartment with non-slip mat	1x Accessories package 1 2x pull-out compartment with non-slip mat	1x Accessories package 1 2x pull-out compartment with non-slip mat
Installation	wall-mounted	wall-mounted	wall-mounted	wall-mounted
Scope of delivery	fastening set included	fastening set included	fastening set included	fastening set included
DH, E8, FP, MS, RH, RK, VG, VH, VJ, VK				
PD				



XX = Insert front and body colour
 DH = Glossy White, FP = Glossy Grey, MS = White Matt, PD = Black Matt
 Lacquer, VG = Truffle Grey, VK = Soft Grey, E8 = White Wood, RH = Oak
 Kansas, RK = Stone Oak, VH = Arizona Oak, VJ = Nordic Oak

COLLARO

€ excl. VAT

Produced to order (Please note that it is not always possible to cancel or change orders!), The washbasins are to be ordered separately.

	VANITY UNIT	VANITY UNIT	VANITY UNIT	VANITY UNIT
				
Article number	C068 00 XX	C068 L0 XX	C065 00 XX	C065 L0 XX
Dimensions (w x h x d)	1600 x 548 x 500 mm	1600 x 548 x 500 mm	1600 x 548 x 500 mm	1600 x 548 x 500 mm
Version	for 2 washbasins	for 2 washbasins	washbasin on the middle	washbasin on the middle
For combination with	Collaro 4A15 51, 4A17 51	Collaro 4A15 51, 4A17 51	Collaro 4A15 51, 4A17 51	Collaro 4A15 51, 4A17 51
Lighting	-	LED lighting Lighting 1x LED / 11,9 W	-	LED lighting Lighting 1x LED / 11,9 W
Equipped with	2x Accessories package 1 4x pull-out compartment with non-slip mat	2x Accessories package 1 4x pull-out compartment with non-slip mat	2x Accessories package 1 4x pull-out compartment with non-slip mat	2x Accessories package 1 4x pull-out compartment with non-slip mat
Please note	Installation of surface-mounted washbasin with tap hole surface on left or right.	Installation of surface-mounted washbasin with tap hole surface on left or right.	Installation of surface-mounted washbasin with tap hole surface on left or right.	Installation of surface-mounted washbasin with tap hole surface on left or right.
Installation	wall-mounted	wall-mounted	wall-mounted	wall-mounted
Scope of delivery	fastening set included	fastening set included	fastening set included	fastening set included
DH, E8, FP, MS, RH, RK, VG, VH, VJ, VK				
PD				





	VANITY UNIT	VANITY UNIT	VANITY UNIT	VANITY UNIT
				
Article number	C066 00 XX	C066 L0 XX	C067 00 XX	C067 L0 XX
Dimensions (w x h x d)	1600 x 548 x 500 mm	1600 x 548 x 500 mm	1600 x 548 x 500 mm	1600 x 548 x 500 mm
Version	washbasin on left	washbasin on left	washbasin on right	washbasin on right
For combination with	Collaro 4A15 51, 4A17 51	Collaro 4A15 51, 4A17 51	Collaro 4A15 51, 4A17 51	Collaro 4A15 51, 4A17 51
Lighting	-	LED lighting Lighting 1x LED / 11,9 W	-	LED lighting Lighting 1x LED / 11,9 W
Equipped with	2x Accessories package 1 4x pull-out compartment with non-slip mat	2x Accessories package 1 4x pull-out compartment with non-slip mat	2x Accessories package 1 4x pull-out compartment with non-slip mat	2x Accessories package 1 4x pull-out compartment with non-slip mat
Please note	Installation of surface-mounted washbasin with tap hole surface on left or right.	Installation of surface-mounted washbasin with tap hole surface on left or right.	Installation of surface-mounted washbasin with tap hole surface on left or right.	Installation of surface-mounted washbasin with tap hole surface on left or right.
Installation	wall-mounted	wall-mounted	wall-mounted	wall-mounted
Scope of delivery	fastening set included	fastening set included	fastening set included	fastening set included
DH, E8, FP, MS, RH, RK, VG, VH, VJ, VK				
PD				

XX = Insert front and body colour
 DH = Glossy White, FP = Glossy Grey, MS = White Matt, PD = Black Matt
 Lacquer, VG = Truffle Grey, VK = Soft Grey, E8 = White Wood, RH = Oak
 Kansas, RK = Stone Oak, VH = Arizona Oak, VJ = Nordic Oak

COLLARO

€ excl. VAT

Produced to order (Please note that it is not always possible to cancel or change orders!), The washbasins are to be ordered separately.





	VANITY UNIT	VANITY UNIT	VANITY UNIT	VANITY UNIT
				
Article number	C064 00 XX	C064 L0 XX	C061 00 XX	C061 L0 XX
Dimensions (w x h x d)	1400 x 548 x 500 mm	1400 x 548 x 500 mm	1400 x 548 x 500 mm	1400 x 548 x 500 mm
Version	for 2 washbasins	for 2 washbasins	washbasin on the middle	washbasin on the middle
For combination with	Collaro 4A15 51, 4A17 51	Collaro 4A15 51, 4A17 51	Collaro 4A15 51, 4A17 51	Collaro 4A15 51, 4A17 51
Lighting	-	LED lighting Lighting 1x LED / 10,4 W	-	LED lighting Lighting 1x LED / 10,4 W
Equipped with	2x Accessories package 1 4x pull-out compartment with non-slip mat	2x Accessories package 1 4x pull-out compartment with non-slip mat	2x Accessories package 1 4x pull-out compartment with non-slip mat	2x Accessories package 1 4x pull-out compartment with non-slip mat
Please note	Installation of surface-mounted washbasin with tap hole surface on left or right.	Installation of surface-mounted washbasin with tap hole surface on left or right.	Installation of surface-mounted washbasin with tap hole surface on left or right.	Installation of surface-mounted washbasin with tap hole surface on left or right.
Installation	wall-mounted	wall-mounted	wall-mounted	wall-mounted
Scope of delivery	fastening set included	fastening set included	fastening set included	fastening set included
DH, E8, FP, MS, RH, RK, VG, VH, VJ, VK				
PD				
	VANITY UNIT	VANITY UNIT	VANITY UNIT	VANITY UNIT
				
Article number	C062 00 XX	C062 L0 XX	C063 00 XX	C063 L0 XX
Dimensions (w x h x d)	1400 x 548 x 500 mm	1400 x 548 x 500 mm	1400 x 548 x 500 mm	1400 x 548 x 500 mm
Version	washbasin on left	washbasin on left	washbasin on right	washbasin on right
For combination with	Collaro 4A15 51, 4A17 51	Collaro 4A15 51, 4A17 51	Collaro 4A15 51, 4A17 51	Collaro 4A15 51, 4A17 51
Lighting	-	LED lighting Lighting 1x LED / 10,4 W	-	LED lighting Lighting 1x LED / 10,4 W
Equipped with	2x Accessories package 1 4x pull-out compartment with non-slip mat	2x Accessories package 1 4x pull-out compartment with non-slip mat	2x Accessories package 1 4x pull-out compartment with non-slip mat	2x Accessories package 1 4x pull-out compartment with non-slip mat
Please note	Installation of surface-mounted washbasin with tap hole surface on left or right.	Installation of surface-mounted washbasin with tap hole surface on left or right.	Installation of surface-mounted washbasin with tap hole surface on left or right.	Installation of surface-mounted washbasin with tap hole surface on left or right.
Installation	wall-mounted	wall-mounted	wall-mounted	wall-mounted
Scope of delivery	fastening set included	fastening set included	fastening set included	fastening set included
DH, E8, FP, MS, RH, RK, VG, VH, VJ, VK				
PD				

XX = Insert front and body colour
 DH = Glossy White, FP = Glossy Grey, MS = White Matt, PD = Black Matt
 Lacquer, VG = Truffle Grey, VK = Soft Grey, E8 = White Wood, RH = Oak
 Kansas, RK = Stone Oak, VH = Arizona Oak, VJ = Nordic Oak

COLLARO

€ excl. VAT

Produced to order (Please note that it is not always possible to cancel or change orders!), The washbasins are to be ordered separately.

	VANITY UNIT	VANITY UNIT	VANITY UNIT	VANITY UNIT
				
Article number	C060 00 XX	C060 L0 XX	C057 00 XX	C057 L0 XX
Dimensions (w x h x d)	1200 x 548 x 500 mm	1200 x 548 x 500 mm	1200 x 548 x 500 mm	1200 x 548 x 500 mm
Version	for 2 washbasins	for 2 washbasins	washbasin on the middle	washbasin on the middle
For combination with	Collaro 4A15 51, 4A17 51	Collaro 4A15 51, 4A17 51	Collaro 4A15 51, 4A17 51	Collaro 4A15 51, 4A17 51
Lighting	-	LED lighting Lighting 1x LED / 8,8 W	-	LED lighting Lighting 1x LED / 8,8 W
Equipped with	2x Accessories package 1 4x pull-out compartment with non-slip mat	2x Accessories package 1 4x pull-out compartment with non-slip mat	2x Accessories package 1 4x pull-out compartment with non-slip mat	2x Accessories package 1 4x pull-out compartment with non-slip mat
Please note	Installation of surface-mounted washbasin with tap hole surface on left or right.	Installation of surface-mounted washbasin with tap hole surface on left or right.	Installation of surface-mounted washbasin with tap hole surface on left or right.	Installation of surface-mounted washbasin with tap hole surface on left or right.
Installation	wall-mounted	wall-mounted	wall-mounted	wall-mounted
Scope of delivery	fastening set included	fastening set included	fastening set included	fastening set included
DH, E8, FP, MS, RH, RK, VG, VH, VJ, VK				
PD				
	VANITY UNIT	VANITY UNIT	VANITY UNIT	VANITY UNIT
				
Article number	C058 00 XX	C058 L0 XX	C059 00 XX	C059 L0 XX
Dimensions (w x h x d)	1200 x 548 x 500 mm	1200 x 548 x 500 mm	1200 x 548 x 500 mm	1200 x 548 x 500 mm
Version	washbasin on left	washbasin on left	washbasin on right	washbasin on right
For combination with	Collaro 4A15 51, 4A17 51	Collaro 4A15 51, 4A17 51	Collaro 4A15 51, 4A17 51	Collaro 4A15 51, 4A17 51
Lighting	-	LED lighting Lighting 1x LED / 8,8 W	-	LED lighting Lighting 1x LED / 8,8 W
Equipped with	2x Accessories package 1 4x pull-out compartment with non-slip mat	2x Accessories package 1 4x pull-out compartment with non-slip mat	2x Accessories package 1 4x pull-out compartment with non-slip mat	2x Accessories package 1 4x pull-out compartment with non-slip mat
Please note	Installation of surface-mounted washbasin with tap hole surface on left or right.	Installation of surface-mounted washbasin with tap hole surface on left or right.	Installation of surface-mounted washbasin with tap hole surface on left or right.	Installation of surface-mounted washbasin with tap hole surface on left or right.
Installation	wall-mounted	wall-mounted	wall-mounted	wall-mounted
Scope of delivery	fastening set included	fastening set included	fastening set included	fastening set included
DH, E8, FP, MS, RH, RK, VG, VH, VJ, VK				
PD				









COLLARO

XX = Insert front and body colour
 DH = Glossy White, FP = Glossy Grey, MS = White Matt, PD = Black Matt
 Lacquer, VG = Truffle Grey, VK = Soft Grey, E8 = White Wood, RH = Oak
 Kansas, RK = Stone Oak, VH = Arizona Oak, VJ = Nordic Oak

COLLARO

€ excl. VAT

Produced to order (Please note that it is not always possible to cancel or change orders!), The washbasins are to be ordered separately.









	VANITY UNIT	VANITY UNIT	VANITY UNIT	VANITY UNIT
				
Article number	C054 00 XX	C054 L0 XX	C055 00 XX	C055 L0 XX
Dimensions (w x h x d)	1000 x 548 x 500 mm	1000 x 548 x 500 mm	1000 x 548 x 500 mm	1000 x 548 x 500 mm
Version	washbasin on the middle	washbasin on the middle	washbasin on left	washbasin on left
For combination with	Collaro 4A15 51, 4A17 51	Collaro 4A15 51, 4A17 51	Collaro 4A15 51, 4A17 51	Collaro 4A15 51, 4A17 51
Lighting	-	LED lighting Lighting 1x LED / 7,2 W	-	LED lighting Lighting 1x LED / 7,2 W
Equipped with	1x Accessories package 1 2x pull-out compartment with non-slip mat	1x Accessories package 1 2x pull-out compartment with non-slip mat	1x Accessories package 1 2x pull-out compartment with non-slip mat	1x Accessories package 1 2x pull-out compartment with non-slip mat
Please note	Installation of surface-mounted washbasin with tap hole surface on left or right.	Installation of surface-mounted washbasin with tap hole surface on left or right.	Installation of surface-mounted washbasin with tap hole surface on left or right.	Installation of surface-mounted washbasin with tap hole surface on left or right.
Installation	wall-mounted	wall-mounted	wall-mounted	wall-mounted
Scope of delivery	fastening set included	fastening set included	fastening set included	fastening set included
DH, E8, FP, MS, RH, RK, VG, VH, VJ, VK				
PD				
	VANITY UNIT	VANITY UNIT	VANITY UNIT	VANITY UNIT
				
Article number	C056 00 XX	C056 L0 XX	C053 00 XX	C053 L0 XX
Dimensions (w x h x d)	1000 x 548 x 500 mm	1000 x 548 x 500 mm	800 x 548 x 500 mm	800 x 548 x 500 mm
Version	washbasin on right	washbasin on right	washbasin on the middle	washbasin on the middle
For combination with	Collaro 4A15 51, 4A17 51	Collaro 4A15 51, 4A17 51	Collaro 4A15 51, 4A17 51	Collaro 4A15 51, 4A17 51
Lighting	-	LED lighting Lighting 1x LED / 7,2 W	-	LED lighting Lighting 1x LED / 5,7 W
Equipped with	1x Accessories package 1 2x pull-out compartment with non-slip mat	1x Accessories package 1 2x pull-out compartment with non-slip mat	1x Accessories package 1 2x pull-out compartment with non-slip mat	1x Accessories package 1 2x pull-out compartment with non-slip mat
Please note	Installation of surface-mounted washbasin with tap hole surface on left or right.	Installation of surface-mounted washbasin with tap hole surface on left or right.	Installation of surface-mounted washbasin with tap hole surface on left or right.	Installation of surface-mounted washbasin with tap hole surface on left or right.
Installation	wall-mounted	wall-mounted	wall-mounted	wall-mounted
Scope of delivery	fastening set included	fastening set included	fastening set included	fastening set included
DH, E8, FP, MS, RH, RK, VG, VH, VJ, VK				
PD				

XX = Insert front and body colour
 DH = Glossy White, FP = Glossy Grey, MS = White Matt, PD = Black Matt
 Lacquer, VG = Truffle Grey, VK = Soft Grey, E8 = White Wood, RH = Oak
 Kansas, RK = Stone Oak, VH = Arizona Oak, VJ = Nordic Oak

COLLARO

€ excl. VAT

Produced to order (Please note that it is not always possible to cancel or change orders!), The washbasins are to be ordered separately.

	VANITY UNIT	VANITY UNIT	VANITY UNIT	VANITY UNIT
				
Article number	C052 00 XX	C052 L0 XX	C049 00 XX	C049 L0 XX
Dimensions (w x h x d)	1600 x 548 x 500 mm	1600 x 548 x 500 mm	1600 x 548 x 500 mm	1600 x 548 x 500 mm
Version	for 2 washbasins	for 2 washbasins	washbasin on the middle	washbasin on the middle
For combination with	Collaro 4A18 40, 4A21 38, 4A19 56, 4A20 56	Collaro 4A18 40, 4A21 38, 4A19 56, 4A20 56	Collaro 4A18 40, 4A21 38, 4A19 56, 4A20 56	Collaro 4A18 40, 4A21 38, 4A19 56, 4A20 56
Lighting	-	LED lighting Lighting 1x LED / 11,9 W	-	LED lighting Lighting 1x LED / 11,9 W
Equipped with	2x Accessories package 1 4x pull-out compartment with non-slip mat	2x Accessories package 1 4x pull-out compartment with non-slip mat	2x Accessories package 1 4x pull-out compartment with non-slip mat	2x Accessories package 1 4x pull-out compartment with non-slip mat
Installation	wall-mounted	wall-mounted	wall-mounted	wall-mounted
Scope of delivery	fastening set included	fastening set included	fastening set included	fastening set included
DH, E8, FP, MS, RH, RK, VG, VH, VJ, VK				
PD				
	VANITY UNIT	VANITY UNIT	VANITY UNIT	VANITY UNIT
				
Article number	C050 00 XX	C050 L0 XX	C051 00 XX	C051 L0 XX
Dimensions (w x h x d)	1600 x 548 x 500 mm	1600 x 548 x 500 mm	1600 x 548 x 500 mm	1600 x 548 x 500 mm
Version	washbasin on left	washbasin on left	washbasin on right	washbasin on right
For combination with	Collaro 4A18 40, 4A21 38, 4A19 56, 4A20 56	Collaro 4A18 40, 4A21 38, 4A19 56, 4A20 56	Collaro 4A18 40, 4A21 38, 4A19 56, 4A20 56	Collaro 4A18 40, 4A21 38, 4A19 56, 4A20 56
Lighting	-	LED lighting Lighting 1x LED / 11,9 W	-	LED lighting Lighting 1x LED / 11,9 W
Equipped with	2x Accessories package 1 4x pull-out compartment with non-slip mat	2x Accessories package 1 4x pull-out compartment with non-slip mat	2x Accessories package 1 4x pull-out compartment with non-slip mat	2x Accessories package 1 4x pull-out compartment with non-slip mat
Installation	wall-mounted	wall-mounted	wall-mounted	wall-mounted
Scope of delivery	fastening set included	fastening set included	fastening set included	fastening set included
DH, E8, FP, MS, RH, RK, VG, VH, VJ, VK				
PD				









COLLARO

XX = Insert front and body colour
 DH = Glossy White, FP = Glossy Grey, MS = White Matt, PD = Black Matt
 Lacquer, VG = Truffle Grey, VK = Soft Grey, E8 = White Wood, RH = Oak
 Kansas, RK = Stone Oak, VH = Arizona Oak, VJ = Nordic Oak

COLLARO

€ excl. VAT

Produced to order (Please note that it is not always possible to cancel or change orders!), The washbasins are to be ordered separately.









	VANITY UNIT	VANITY UNIT	VANITY UNIT	VANITY UNIT
				
Article number	C048 00 XX	C048 L0 XX	C045 00 XX	C045 L0 XX
Dimensions (w x h x d)	1400 x 548 x 500 mm	1400 x 548 x 500 mm	1400 x 548 x 500 mm	1400 x 548 x 500 mm
Version	for 2 washbasins	for 2 washbasins	washbasin on the middle	washbasin on the middle
For combination with	Collaro 4A18 40, 4A21 38, 4A19 56, 4A20 56	Collaro 4A18 40, 4A21 38, 4A19 56, 4A20 56	Collaro 4A18 40, 4A21 38, 4A19 56, 4A20 56	Collaro 4A18 40, 4A21 38, 4A19 56, 4A20 56
Lighting	-	LED lighting Lighting 1x LED / 10,4 W	-	LED lighting Lighting 1x LED / 10,4 W
Equipped with	2x Accessories package 1 4x pull-out compartment with non-slip mat	2x Accessories package 1 4x pull-out compartment with non-slip mat	2x Accessories package 1 4x pull-out compartment with non-slip mat	2x Accessories package 1 4x pull-out compartment with non-slip mat
Installation	wall-mounted	wall-mounted	wall-mounted	wall-mounted
Scope of delivery	fastening set included	fastening set included	fastening set included	fastening set included
DH, E8, FP, MS, RH, RK, VG, VH, VJ, VK				
PD				
	VANITY UNIT	VANITY UNIT	VANITY UNIT	VANITY UNIT
				
Article number	C046 00 XX	C046 L0 XX	C047 00 XX	C047 L0 XX
Dimensions (w x h x d)	1400 x 548 x 500 mm	1400 x 548 x 500 mm	1400 x 548 x 500 mm	1400 x 548 x 500 mm
Version	washbasin on left	washbasin on left	washbasin on right	washbasin on right
For combination with	Collaro 4A18 40, 4A21 38, 4A19 56, 4A20 56	Collaro 4A18 40, 4A21 38, 4A19 56, 4A20 56	Collaro 4A18 40, 4A21 38, 4A19 56, 4A20 56	Collaro 4A18 40, 4A21 38, 4A19 56, 4A20 56
Lighting	-	LED lighting Lighting 1x LED / 10,4 W	-	LED lighting Lighting 1x LED / 10,4 W
Equipped with	2x Accessories package 1 4x pull-out compartment with non-slip mat	2x Accessories package 1 4x pull-out compartment with non-slip mat	2x Accessories package 1 4x pull-out compartment with non-slip mat	2x Accessories package 1 4x pull-out compartment with non-slip mat
Installation	wall-mounted	wall-mounted	wall-mounted	wall-mounted
Scope of delivery	fastening set included	fastening set included	fastening set included	fastening set included
DH, E8, FP, MS, RH, RK, VG, VH, VJ, VK				
PD				

XX = Insert front and body colour
 DH = Glossy White, FP = Glossy Grey, MS = White Matt, PD = Black Matt
 Lacquer, VG = Truffle Grey, VK = Soft Grey, E8 = White Wood, RH = Oak
 Kansas, RK = Stone Oak, VH = Arizona Oak, VJ = Nordic Oak

COLLARO

€ excl. VAT

Produced to order (Please note that it is not always possible to cancel or change orders!), The washbasins are to be ordered separately.

	VANITY UNIT	VANITY UNIT	VANITY UNIT	VANITY UNIT
				
Article number	C044 00 XX	C044 L0 XX	C041 00 XX	C041 L0 XX
Dimensions (w x h x d)	1200 x 548 x 500 mm	1200 x 548 x 500 mm	1200 x 548 x 500 mm	1200 x 548 x 500 mm
Version	for 2 washbasins	for 2 washbasins	washbasin on the middle	washbasin on the middle
For combination with	Collaro 4A18 40, 4A21 38, 4A19 56, 4A20 56	Collaro 4A18 40, 4A21 38, 4A19 56, 4A20 56	Collaro 4A18 40, 4A21 38, 4A19 56, 4A20 56	Collaro 4A18 40, 4A21 38, 4A19 56, 4A20 56
Lighting	-	LED lighting Lighting 1x LED / 8,8 W	-	LED lighting Lighting 1x LED / 8,8 W
Equipped with	2x Accessories package 1 4x pull-out compartment with non-slip mat	2x Accessories package 1 4x pull-out compartment with non-slip mat	2x Accessories package 1 4x pull-out compartment with non-slip mat	2x Accessories package 1 4x pull-out compartment with non-slip mat
Installation	wall-mounted	wall-mounted	wall-mounted	wall-mounted
Scope of delivery	fastening set included	fastening set included	fastening set included	fastening set included
DH, E8, FP, MS, RH, RK, VG, VH, VJ, VK				
PD				
	VANITY UNIT	VANITY UNIT	VANITY UNIT	VANITY UNIT
				
Article number	C042 00 XX	C042 L0 XX	C043 00 XX	C043 L0 XX
Dimensions (w x h x d)	1200 x 548 x 500 mm	1200 x 548 x 500 mm	1200 x 548 x 500 mm	1200 x 548 x 500 mm
Version	washbasin on left	washbasin on left	washbasin on right	washbasin on right
For combination with	Collaro 4A18 40, 4A21 38, 4A19 56, 4A20 56	Collaro 4A18 40, 4A21 38, 4A19 56, 4A20 56	Collaro 4A18 40, 4A21 38, 4A19 56, 4A20 56	Collaro 4A18 40, 4A21 38, 4A19 56, 4A20 56
Lighting	-	LED lighting Lighting 1x LED / 8,8 W	-	LED lighting Lighting 1x LED / 8,8 W
Equipped with	2x Accessories package 1 4x pull-out compartment with non-slip mat	2x Accessories package 1 4x pull-out compartment with non-slip mat	2x Accessories package 1 4x pull-out compartment with non-slip mat	2x Accessories package 1 4x pull-out compartment with non-slip mat
Installation	wall-mounted	wall-mounted	wall-mounted	wall-mounted
Scope of delivery	fastening set included	fastening set included	fastening set included	fastening set included
DH, E8, FP, MS, RH, RK, VG, VH, VJ, VK				
PD				









COLLARO

XX = Insert front and body colour
 DH = Glossy White, FP = Glossy Grey, MS = White Matt, PD = Black Matt
 Lacquer, VG = Truffle Grey, VK = Soft Grey, E8 = White Wood, RH = Oak
 Kansas, RK = Stone Oak, VH = Arizona Oak, VJ = Nordic Oak

COLLARO

€ excl. VAT

Produced to order (Please note that it is not always possible to cancel or change orders!), The washbasins are to be ordered separately.

	VANITY UNIT	VANITY UNIT	VANITY UNIT	VANITY UNIT
				
Article number	C038 00 XX	C038 L0 XX	C039 00 XX	C039 L0 XX
Dimensions (w x h x d)	1000 x 548 x 500 mm	1000 x 548 x 500 mm	1000 x 548 x 500 mm	1000 x 548 x 500 mm
Version	washbasin on the middle	washbasin on the middle	washbasin on left	washbasin on left
For combination with	Collaro 4A18 40, 4A21 38, 4A19 56, 4A20 56	Collaro 4A18 40, 4A21 38, 4A19 56, 4A20 56	Collaro 4A18 40, 4A21 38, 4A19 56, 4A20 56	Collaro 4A18 40, 4A21 38, 4A19 56, 4A20 56
Lighting	-	LED lighting Lighting 1x LED / 7,2 W	-	LED lighting Lighting 1x LED / 7,2 W
Equipped with	1x Accessories package 1 2x pull-out compartment with non-slip mat	1x Accessories package 1 2x pull-out compartment with non-slip mat	1x Accessories package 1 2x pull-out compartment with non-slip mat	1x Accessories package 1 2x pull-out compartment with non-slip mat
Installation	wall-mounted	wall-mounted	wall-mounted	wall-mounted
Scope of delivery	fastening set included	fastening set included	fastening set included	fastening set included
DH, E8, FP, MS, RH, RK, VG, VH, VJ, VK				
PD				
	VANITY UNIT	VANITY UNIT	VANITY UNIT	VANITY UNIT
				
Article number	C040 00 XX	C040 L0 XX	C037 00 XX	C037 L0 XX
Dimensions (w x h x d)	1000 x 548 x 500 mm	1000 x 548 x 500 mm	800 x 548 x 500 mm	800 x 548 x 500 mm
Version	washbasin on right	washbasin on right	washbasin on the middle	washbasin on the middle
For combination with	Collaro 4A18 40, 4A21 38, 4A19 56, 4A20 56	Collaro 4A18 40, 4A21 38, 4A19 56, 4A20 56	Collaro 4A18 40, 4A21 38, 4A19 56, 4A20 56	Collaro 4A18 40, 4A21 38, 4A19 56, 4A20 56
Lighting	-	LED lighting Lighting 1x LED / 7,2 W	-	LED lighting Lighting 1x LED / 5,7 W
Equipped with	1x Accessories package 1 2x pull-out compartment with non-slip mat	1x Accessories package 1 2x pull-out compartment with non-slip mat	1x Accessories package 1 2x pull-out compartment with non-slip mat	1x Accessories package 1 2x pull-out compartment with non-slip mat
Installation	wall-mounted	wall-mounted	wall-mounted	wall-mounted
Scope of delivery	fastening set included	fastening set included	fastening set included	fastening set included
DH, E8, FP, MS, RH, RK, VG, VH, VJ, VK				
PD				

XX = Insert front and body colour
 DH = Glossy White, FP = Glossy Grey, MS = White Matt, PD = Black Matt
 Lacquer, VG = Truffle Grey, VK = Soft Grey, E8 = White Wood, RH = Oak
 Kansas, RK = Stone Oak, VH = Arizona Oak, VJ = Nordic Oak

COLLARO

€ excl. VAT

Produced to order (Please note that it is not always possible to cancel or change orders!), The washbasins are to be ordered separately.

	TALL CABINET	TALL CABINET	TALL CABINET	TALL CABINET
				
Article number	C033 00 XX	C033 L0 XX	C033 01 XX	C033 L1 XX
Dimensions (w x h x d)	404 x 1538 x 349 mm	404 x 1538 x 349 mm	404 x 1538 x 349 mm	404 x 1538 x 349 mm
Hinges	hinges on left	hinges on left	hinges on right	hinges on right
Lighting	-	LED lighting Lighting 1x LED / 2,7 W	-	LED lighting Lighting 1x LED / 2,7 W
Equipped with	2x door 1x fixed shelf 3x glass shelf	2x door 1x fixed shelf 3x glass shelf	2x door 1x fixed shelf 3x glass shelf	2x door 1x fixed shelf 3x glass shelf
Installation	wall-mounted	wall-mounted	wall-mounted	wall-mounted
Scope of delivery	fastening set included	fastening set included	fastening set included	fastening set included
DH, E8, FP, MS, RH, RK, VG, VH, VJ, VK				
PD				

	TALL CABINET	TALL CABINET	TALL CABINET	TALL CABINET
				
Article number	C034 00 XX	C034 L0 XX	C034 01 XX	C034 L1 XX
Dimensions (w x h x d)	454 x 1538 x 349 mm	454 x 1538 x 349 mm	454 x 1538 x 349 mm	454 x 1538 x 349 mm
Hinges	hinges on left	hinges on left	hinges on right	hinges on right
Lighting	-	LED lighting Lighting 1x LED / 3,1 W	-	LED lighting Lighting 1x LED / 3,1 W
Equipped with	1x door 1 x laundry flap 1x glass shelf	2x door with a laundry basket 1x glass shelf	1x door 1 x laundry flap 1x glass shelf	2x door with a laundry basket 1x glass shelf
Installation	wall-mounted	wall-mounted	wall-mounted	wall-mounted
Scope of delivery	fastening set included	fastening set included	fastening set included	fastening set included
DH, E8, FP, MS, RH, RK, VG, VH, VJ, VK				
PD				



COLLARO

XX = Insert front and body colour
 DH = Glossy White, FP = Glossy Grey, MS = White Matt, PD = Black Matt
 Lacquer, VG = Truffle Grey, VK = Soft Grey, E8 = White Wood, RH = Oak
 Kansas, RK = Stone Oak, VH = Arizona Oak, VJ = Nordic Oak

COLLARO

€ excl. VAT

Produced to order (Please note that it is not always possible to cancel or change orders!), The washbasins are to be ordered separately.

	TALL CABINET	TALL CABINET	TALL CABINET	TALL CABINET
				
Article number	C035 D0 XX	C035 LD XX	C036 D1 XX	C036 LD XX
Dimensions (w x h x d)	404 x 1538 x 349 mm	404 x 1538 x 349 mm	404 x 1538 x 349 mm	404 x 1538 x 349 mm
Hinges	hinges on left	hinges on left	hinges on right	hinges on right
Lighting	-	LED lighting Lighting 1x LED / 11,6 W	-	LED lighting Lighting 1x LED / 11,6 W
Equipped with	door with mirror on both sides 1x fixed shelf 3x glass shelf 2x socket	door with mirror on both sides 1x fixed shelf 3x glass shelf 2x socket	door with mirror on both sides 1x fixed shelf 3x glass shelf 2x socket	door with mirror on both sides 1x fixed shelf 3x glass shelf 2x socket
Installation	wall-mounted	wall-mounted	wall-mounted	wall-mounted
Scope of delivery	fastening set included	fastening set included	fastening set included	fastening set included
DH, E8, FP, MS, RH, RK, VG, VH, VJ, VK				
PD				
	SIDE CABINET	SIDE CABINET	SIDE CABINET	SIDE CABINET
				
Article number	C032 00 XX	C032 L0 XX	C032 01 XX	C032 L1 XX
Dimensions (w x h x d)	404 x 748 x 349 mm	404 x 748 x 349 mm	404 x 748 x 349 mm	404 x 748 x 349 mm
Hinges	hinges on left	hinges on left	hinges on right	hinges on right
Lighting	-	LED lighting Lighting 1x LED / 2,7 W	-	LED lighting Lighting 1x LED / 2,7 W
Equipped with	1x door 1x drawer with non-slip mat 1x glass shelf	1x door 1x drawer with non-slip mat 1x glass shelf	1x door 1x drawer with non-slip mat 1x glass shelf	1x door 1x drawer with non-slip mat 1x glass shelf
Installation	wall-mounted	wall-mounted	wall-mounted	wall-mounted
Scope of delivery	fastening set included	fastening set included	fastening set included	fastening set included
DH, E8, FP, MS, RH, RK, VG, VH, VJ, VK				
PD				



COLLARO

XX = Insert front and body colour
 DH = Glossy White, FP = Glossy Grey, MS = White Matt, PD = Black Matt
 Lacquer, VG = Truffle Grey, VK = Soft Grey, E8 = White Wood, RH = Oak
 Kansas, RK = Stone Oak, VH = Arizona Oak, VJ = Nordic Oak

COLLARO

€ excl. VAT

Produced to order (Please note that it is not always possible to cancel or change orders!), The washbasins are to be ordered separately.

	REMOTE CONTROL, INCLUDING MOUNT
	
	
Article number	G999 02 00
Dimensions (w x h x d)	40 x 10 x 115 mm
Description	one remote control for all Collaro and Finion articles, is required to operate all Collaro and Finion lighting elements
Scope of delivery	not included in scope of delivery

XX = Insert front and body colour

DH = Glossy White, FP = Glossy Grey, MS = White Matt, PD = Black Matt

Lacquer, VG = Truffle Grey, VK = Soft Grey, E8 = White Wood, RH = Oak

Kansas, RK = Stone Oak, VH = Arizona Oak, VJ = Nordic Oak

EVANA

Bath ceramic

- Mainstream segment

PRO.VILLEROY-BOCH.COM/TECHNICALDRAWINGS



EVANA

Ceramic colours



01 = White Alpin



R1 = White Alpin
CeramicPlus

EVANA

€ excl. VAT



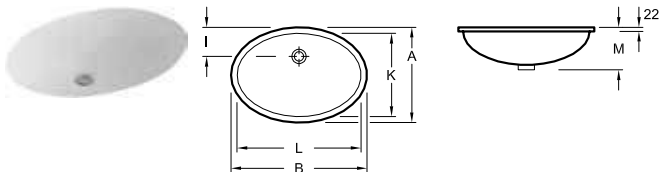

Registered design

Please order tap fittings and soap dispenser separately

UNDERCOUNTER WASHBASIN



Article no.	A	B	I	K	L	M
614400XX	475	675	150	415	615	215
614700XX	410	570	140	350	500	215
614746XX	365	520	125	305	455	190

Article number	Description	01	 R1	pcs/ pal.	kg/ pc.
6144 00 XX	615 x 415 mm without tap hole area 			12	13,7
6147 00 XX	500 x 350 mm without tap hole area 			10	10,7
6147 46 XX	455 x 305 mm without tap hole area 			28	10,43

outside surface glazed, the hole for the washbasin can only be cut out using the original washbasin because tolerances of several millimetres are possible, fastening set included

For further information about matching valves, see pages 380-383

FINION

Sanitaryware and Bathroom Furniture

PRO.VILLEROY-BOCH.COM/TECHNICALDRAWINGS

- Premium segment
- Matching furniture programme Finion
- Match washbasins in the collections Artis, Collaro, Finion, Memento 2.0
- Selected washbasins also match the furniture programme Legato
- matching wellness programme Finion



Ceramic colours



R1 = White Alpin
CeramicPlus



RW = Stone
White
CeramicPlus

Front- / Body- / Shelf colours



GF = Glossy
White Lacquer



GJ = Light Grey
Matt Lacquer



GK = Anthracite
Matt Lacquer



GM = Olive Matt
Lacquer



HB = Peony
Matt Lacquer



HG = Midnight
Blue Matt
Lacquer



HH = Sand Matt
Lacquer



MT = White Matt
Lacquer



PD = Black Matt
Lacquer



PH = Glossy
Black Lacquer



GN = Walnut
Veneer



PC = Oak
Veneer

Additional Shelf colour



HF = Gold Matt
Lacquer

Top colours



1 = Glass White
Matt



2 = Glass Black
Matt

FINION

Bathroom furniture

The article numbers for the Finion bathroom furniture are made up as follows:

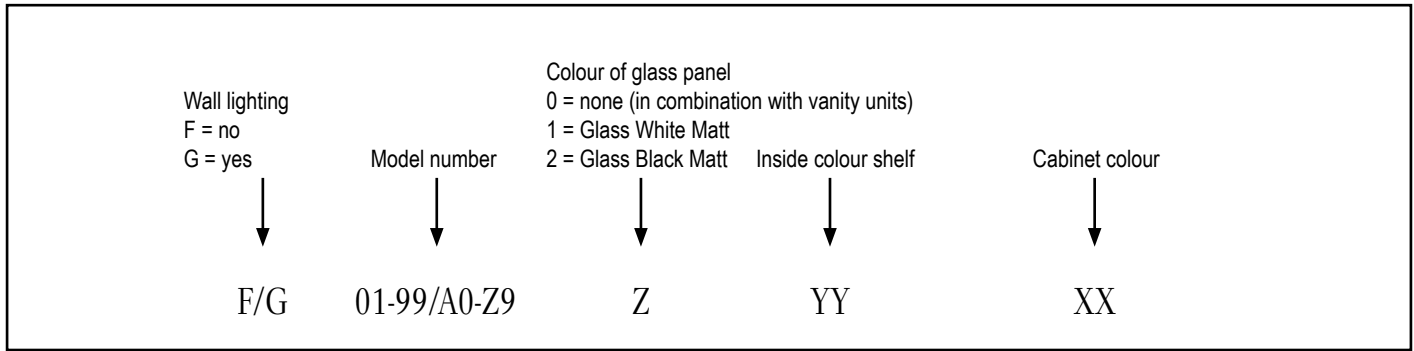

Individual bathroom design

As the cabinet colour and shelf colour* can be freely combined, colours can be used to add a personal touch to the bathroom.



* HF - Gold Matt Lacquer only available as shelf colour



Comprehensive lighting concept

The collection's comprehensive lighting concept is operated via a control unit. This can be ordered separately under the following article number: G999 02 00.

This enables the operation of both the entire lighting concept and individual lighting elements.

- Shelf elements are always lit indirectly
- Certain specific shelf modules are also available without illumination
- All furniture models are available as an option with wall lighting
- LED lighting, continuously dimmable, freely adjustable light colour from daylight white to warm white
- Finion bath lighting can be added
- Only one control unit needed per bathroom
- Factory default setting of the lighting elements can also be modified individually at a later stage

Bath ceramic

ViFlow outlet and overflow system for Finion washbasins

ViFlow performs the overflow function and is concealed below the washbasin.

- Ceramic valve cover in the colours White Alpin and Stone White
- To match tap fittings with turn knob operation
- Closing valve without moving the ceramic valve cover
- Variable adjustment of the overflow height and water level
- Hygienic thanks to optimum flow properties
- Tested as per EN 274-3



FINION

€ excl. VAT

Registered design

Please order tap fittings and soap dispenser separately

VANITY WASHBASIN

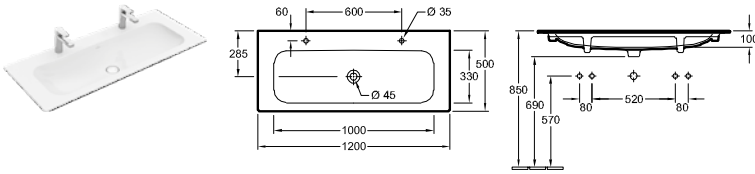

Article number	Description		plus R1	plus RW		pcs/ pal.	kg/ pc.
4164 C1 XX	1200 x 500 mm	Titan Ceram			-	6	23,7

incl. unclosable valve with ceramic valve cover, matching furniture programme: Finion

VANITY WASHBASIN

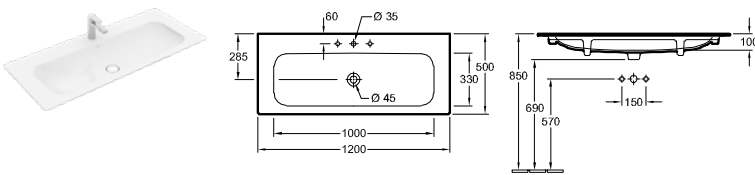

Article number	Description		plus R1	plus RW		pcs/ pal.	kg/ pc.
4164 C2 XX	1200 x 500 mm incl. unclosable valve with ceramic valve cover	Titan Ceram			-	6	23,7
4164 CB XX	1200 x 500 mm incl. concealed ViFlow overflow with ceramic valve cover	ViFlow Titan Ceram			-	6	23,7
4164 C3 XX	1200 x 500 mm incl. unclosable valve with ceramic valve cover	Titan Ceram			-	6	23,7

matching furniture programme: Finion

VANITY WASHBASIN

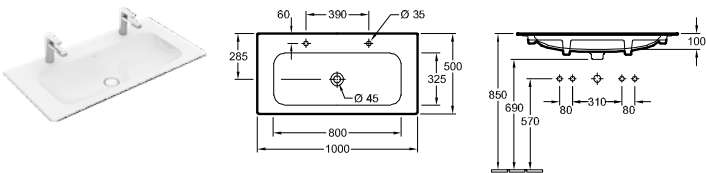

Article number	Description		plus R1	plus RW		pcs/ pal.	kg/ pc.
4164 A1 XX	1000 x 500 mm	Titan Ceram			-	6	21,1

incl. unclosable valve with ceramic valve cover, matching furniture programme: Finion

VANITY WASHBASIN

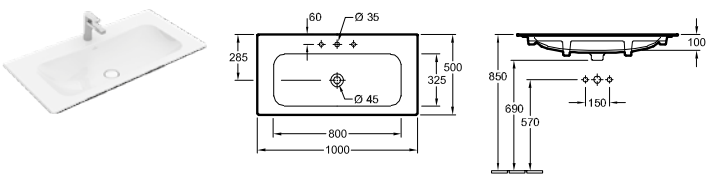

Article number	Description		plus R1	plus RW		pcs/ pal.	kg/ pc.
4164 A2 XX	1000 x 500 mm incl. unclosable valve with ceramic valve cover	Titan Ceram			-	6	21,1
4164 AB XX	1000 x 500 mm incl. concealed ViFlow overflow with ceramic valve cover	ViFlow Titan Ceram			-	6	21,1
4164 A3 XX	1000 x 500 mm incl. unclosable valve with ceramic valve cover	Titan Ceram			-	6	21,1

matching furniture programme: Finion

XX = Colour code to be indicated
R1 = White Alpin CeramicPlus, RW = Stone White CeramicPlus

FINION

€ excl. VAT

Registered design

Please order tap fittings and soap dispenser separately

VANITY WASHBASIN

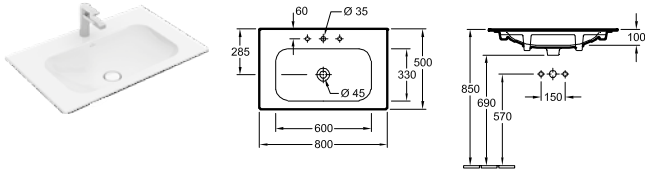

Article number	Description	plus		pcs/pal.	kg/pc.
		R1	RW		
4164 81 XX	800 x 500 mm incl. unclosable valve with ceramic valve cover			-	6 16,8
4164 84 XX	800 x 500 mm incl. concealed ViFlow overflow with ceramic valve cover			-	6 16,8
4164 83 XX	800 x 500 mm incl. unclosable valve with ceramic valve cover			-	6 16,8

matching furniture programme: Finion

DOUBLE WASHBASIN

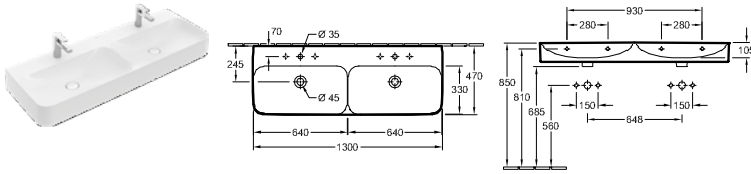

Article number	Description	plus		pcs/pal.	kg/pc.
		R1	RW		
4139 D2 XX	1300 x 470 mm incl. unclosable valve with ceramic valve cover			-	8 37,6
4139 D8 XX	1300 x 470 mm incl. concealed ViFlow overflow with ceramic valve cover			-	8 37,6

wall fixation

9221 49 00	WASHBASIN INSTALLATION ELEMENT 525 x 1120 x 75 mm For further ViConnect models, see pages 368-379				10 8,05
------------	--	--	--	--	---------

DOUBLE WASHBASIN

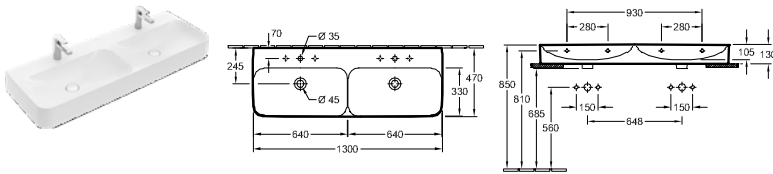

Article number	Description	plus		pcs/pal.	kg/pc.
		R1	RW		
4139 DG XX	1300 x 470 mm incl. unclosable valve with ceramic valve cover			-	8 37,6
4139 DC XX	1300 x 470 mm incl. concealed ViFlow overflow with ceramic valve cover			-	8 37,6

ground underside, wall fixation, matching furniture programme: Finion

9221 49 00	WASHBASIN INSTALLATION ELEMENT 525 x 1120 x 75 mm For further ViConnect models, see pages 368-379				10 8,05
------------	--	--	--	--	---------

XX = Colour code to be indicated
R1 = White Alpin CeramicPlus, RW = Stone White CeramicPlus

FINION



€ excl. VAT

Registered design

Please order tap fittings and soap dispenser separately

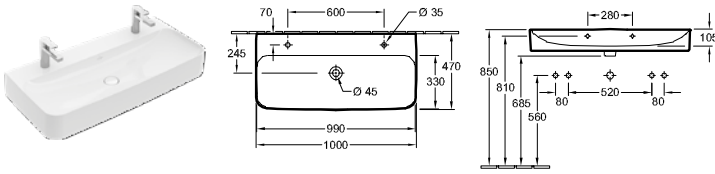







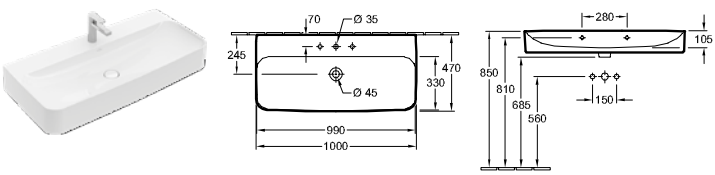

WASHBASINS



Article number	Description		plus R1	plus RW		pcs/ pal.	kg/ pc.
4168 A1 XX	1000 x 470 mm 2xO 				-	8	28
wall fixation, incl. unclosable valve with ceramic valve cover							
9221 49 00	WASHBASIN INSTALLATION ELEMENT 525 x 1120 x 75 mm For further ViConnect models, see pages 368-379		-	-		10	8,05



WASHBASINS

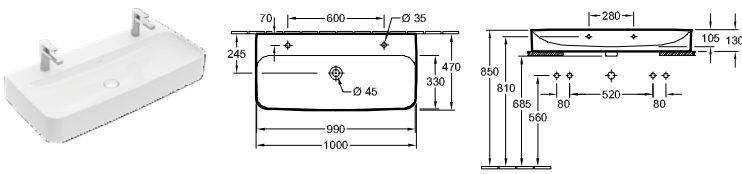

Article number	Description		plus R1	plus RW		pcs/ pal.	kg/ pc.
4168 A2 XX	1000 x 470 mm    incl. unclosable valve with ceramic valve cover				-	8	28
4168 AB XX	1000 x 470 mm    incl. concealed ViFlow overflow with ceramic valve cover	 			-	8	28
wall fixation							
9221 49 00	WASHBASIN INSTALLATION ELEMENT 525 x 1120 x 75 mm For further ViConnect models, see pages 368-379		-	-		10	8,05

WASHBASINS



Article number	Description		plus R1	plus RW		pcs/ pal.	kg/ pc.
4168 1L XX	1000 x 470 mm 2xO 				-	8	28
ground underside, wall fixation, incl. unclosable valve with ceramic valve cover, matching furniture programme: Finion							
9221 49 00	WASHBASIN INSTALLATION ELEMENT 525 x 1120 x 75 mm For further ViConnect models, see pages 368-379		-	-		10	8,05

XX = Colour code to be indicated
R1 = White Alpin CeramicPlus, RW = Stone White CeramicPlus

FINION

€ excl. VAT

Registered design

Please order tap fittings and soap dispenser separately

WASHBASINS

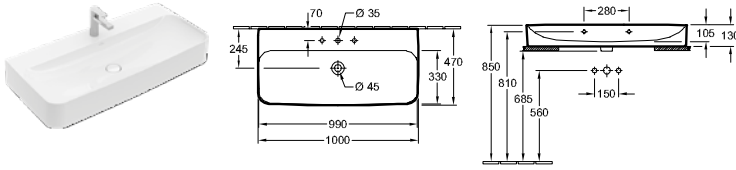

Article number	Description		plus R1	plus RW		pcs/ pal.	kg/ pc.
4168 1H XX	1000 x 470 mm incl. unclosable valve with ceramic valve cover				-	8	28
4168 1B XX	1000 x 470 mm incl. concealed ViFlow overflow with ceramic valve cover				-	8	28

ground underside, wall fixation, matching furniture programme: Finion

9221 49 00	WASHBASIN INSTALLATION ELEMENT 525 x 1120 x 75 mm For further ViConnect models, see pages 368-379		-	-		10	8,05
------------	--	--	---	---	--	----	------

WASHBASINS

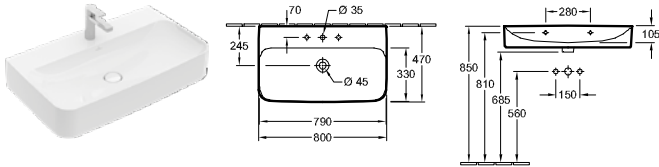

Article number	Description		plus R1	plus RW		pcs/ pal.	kg/ pc.
4168 81 XX	800 x 470 mm incl. unclosable valve with ceramic valve cover				-	12	23,8
4168 84 XX	800 x 470 mm incl. concealed ViFlow overflow with ceramic valve cover				-	12	23,8

wall fixation

9221 49 00	WASHBASIN INSTALLATION ELEMENT 525 x 1120 x 75 mm For further ViConnect models, see pages 368-379		-	-		10	8,05
------------	--	--	---	---	--	----	------

WASHBASINS

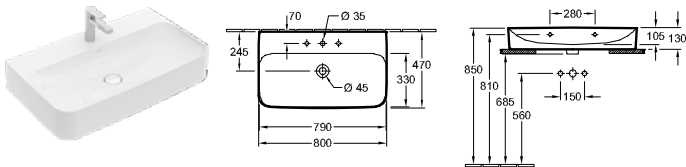

Article number	Description		plus R1	plus RW		pcs/ pal.	kg/ pc.
4168 8L XX	800 x 470 mm incl. unclosable valve with ceramic valve cover				-	12	23,8
4168 8C XX	800 x 470 mm incl. concealed ViFlow overflow with ceramic valve cover				-	12	23,8

ground underside, wall fixation, matching furniture programme: Finion

9221 49 00	WASHBASIN INSTALLATION ELEMENT 525 x 1120 x 75 mm For further ViConnect models, see pages 368-379		-	-		10	8,05
------------	--	--	---	---	--	----	------

XX = Colour code to be indicated

R1 = White Alpin CeramicPlus, RW = Stone White CeramicPlus

FINION

€ excl. VAT

Registered design

Please order tap fittings and soap dispenser separately

WASHBASINS

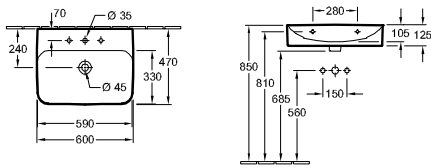

Article number	Description	plus		pcs/ pal.	kg/ pc.
		R1	RW		
4168 61 XX	600 x 470 mm incl. unclosable valve with ceramic valve cover			-	10 17,5
4168 64 XX	600 x 470 mm incl. concealed ViFlow overflow with ceramic valve cover			-	10 17,5
wall fixation					
9221 49 00	WASHBASIN INSTALLATION ELEMENT 525 x 1120 x 75 mm For further ViConnect models, see pages 368-379				10 8,05

WASHBASINS

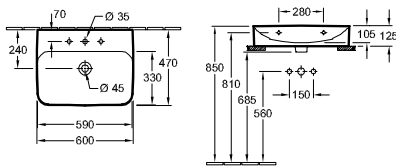

Article number	Description	plus		pcs/ pal.	kg/ pc.
		R1	RW		
4168 6L XX	600 x 470 mm incl. unclosable valve with ceramic valve cover			-	10 17,5
4168 6C XX	600 x 470 mm incl. concealed ViFlow overflow with ceramic valve cover			-	10 17,5
ground underside, wall fixation, matching furniture programme: Finion					
9221 49 00	WASHBASIN INSTALLATION ELEMENT 525 x 1120 x 75 mm For further ViConnect models, see pages 368-379				10 8,05

SURFACE-MOUNTED WASHBASIN

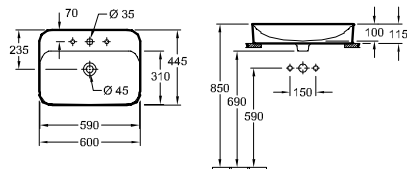

Article number	Description	plus		pcs/ pal.	kg/ pc.
		R1	RW		
4142 61 XX	600 x 445 mm incl. unclosable valve with ceramic valve cover, fastening set included, incl. template			-	12 16,4
4142 64 XX	600 x 445 mm incl. concealed ViFlow overflow with ceramic valve cover, fastening set included, incl. template			-	12 16,4

Recommendation: to be installed with a gap of at least 35 mm between the washbasin and the wall, matching furniture programme: Finion

XX = Colour code to be indicated
R1 = White Alpin CeramicPlus, RW = Stone White CeramicPlus

FINION



€ excl. VAT

Registered design

Please order tap fittings and soap dispenser separately

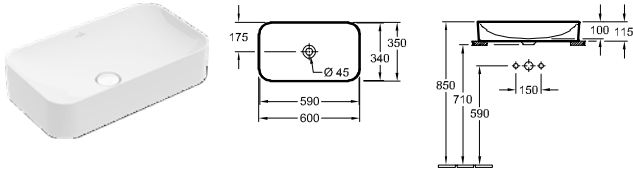
SURFACE-MOUNTED WASHBASIN





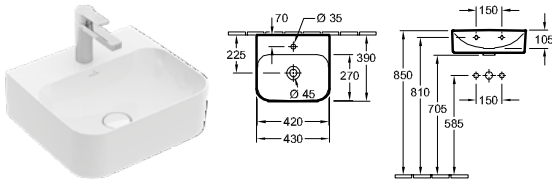

Article number	Description		plus R1	plus RW		pcs/ pal.	kg/ pc.
4143 61 XX	600 x 350 mm for wall-mounted washbasin mixers or tall pillar tap fittings, without tap hole area 				-	10	11,7

incl. unclosable valve with ceramic valve cover, fastening set included, incl. installation instructions, matching furniture programme: Finion

HANDWASHBASIN







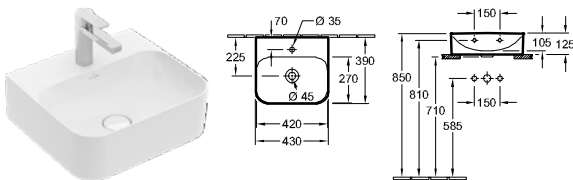

Article number	Description		plus R1	plus RW		pcs/ pal.	kg/ pc.
4364 43 XX	430 x 390 mm  incl. unclosable valve with ceramic valve cover				-	16	10,8
4364 44 XX	430 x 390 mm  incl. concealed ViFlow overflow with ceramic valve cover	 			-	16	10,8

wall fixation

9221 49 00	WASHBASIN INSTALLATION ELEMENT 525 x 1120 x 75 mm For further ViConnect models, see pages 368-379					10	8,05
------------	--	---	--	--	--	----	------

HANDWASHBASIN



Article number	Description		plus R1	plus RW		pcs/ pal.	kg/ pc.
4364 4L XX	430 x 390 mm  incl. unclosable valve with ceramic valve cover				-	16	10,8
4364 4C XX	430 x 390 mm  incl. concealed ViFlow overflow with ceramic valve cover	 			-	16	10,8

ground underside, wall fixation, matching furniture programme: Finion

9221 49 00	WASHBASIN INSTALLATION ELEMENT 525 x 1120 x 75 mm For further ViConnect models, see pages 368-379					10	8,05
------------	--	---	--	--	--	----	------

XX = Colour code to be indicated

R1 = White Alpin CeramicPlus, RW = Stone White CeramicPlus

FINION



€ excl. VAT

Registered design

Please order tap fittings and soap dispenser separately

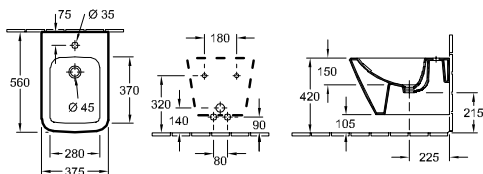
BIDET





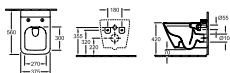

Article number	Description	plus R1	plus RW		pcs/pal.	kg/pc.
4465 00 XX	375 x 560 mm  				12	24
wall-mounted, incl. closing valve with ceramic valve cover						
9953 00 00	FASTENING FRAME (optional)	-	-			2,93
9221 48 00	BIDET INSTALLATION SYSTEM 525 x 1120 x 100 mm For further ViConnect models, see pages 368-379		-	-	10	10,54

WASHDOWN TOILET, RIMLESS

DirectFlush



Article number	Description	plus R1	plus RW		pcs/pal.	kg/pc.
4664 R0 XX	375 x 560 mm	  			12	29
wall-mounted, horizontal outlet, incl. fastening set "SupraFix 3.0", with water-saving AQUAREDUCT® system: flush volume 3 / 4,5 litres, not suitable for installation with flush valves						
9M88 S1 XX	TOILET SEAT AND COVER with QuickRelease and SoftClosing hinges, hinges in stainless steel				108	2,7
9222 87 00	VIPROTECT SOUNDPROOFING SET (optional) incl. accessories				600	0,086
9224 65 00	TOILET INSTALLATION SYSTEM for dry-wall construction, low 450 x 1120 x 165 mm For further ViConnect models, see pages 368-379		-	-	8	19,78
9224 27 00	TOILET INSTALLATION SYSTEM for dry-wall construction, standard height 525 x 1120 x 135 mm For further ViConnect models, see pages 368-379		-	-	10	15,8

XX = Colour code to be indicated

R1 = White Alpin CeramicPlus, RW = Stone White CeramicPlus

FINION

€ excl. VAT

Registered design

Please order tap fittings and soap dispenser separately

SIPHONIC URINAL



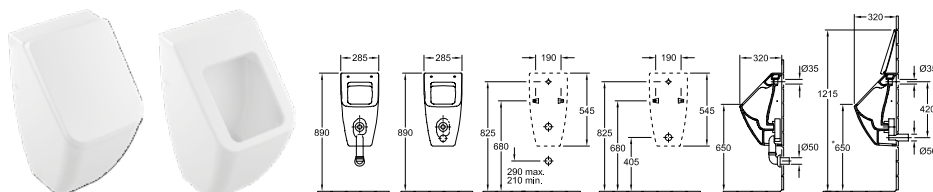

DirectFlush

We recommend the urinal from VENTICELLO for use with FINION



Article number	Description	01	plus R1	plus RW		pcs/ pal.	kg/ pc.
5504 R1 XX	285 x 545 x 315 mm for cover	Direct Flush			-	15	17
5504 R0 XX	285 x 545 x 315 mm without cover	Direct Flush			-	15	17























with fastening set for concealed fastening, concealed water inlet, Outlet may be concealed depending on the type of extractor section

8M10 S1 XX	COVER with SoftClosing hinges, chrome hinges					240	1,3
9326 00 00	EXTRACTOR (optional) horizontal outlet, Flush volume: 1,0 l		-	-	-		0,164
9327 00 00	EXTRACTOR (optional) vertical outlet, Flush volume: 1,0 l		-	-	-		0,175
9319 00 00	CONNECTION PIECES (optional) comprising: collar, outlet elbow, drain pipe 150 mm long		-	-	-		0,232
9933 00 00	WATER-INLET CONNECTOR (optional)		-	-	-		0,2
9190 B1 00	PRODETECT 2 RADAR FLUSH CONTROL FOR URINALS (optional) electronic urinal flushing system, battery-operated (6 x 1.5 V AAA required), pipe thread inlet connector 1/2"	Pro Detect 2	-	-	-		0,974
9190 N1 00	PRODETECT 2 RADAR FLUSH CONTROL FOR URINALS (optional) electronic urinal flushing system, mains-powered (110 - 240 V), Bluetooth-compatible thanks to optional adapter, pipe thread inlet connector 1/2"	Pro Detect 2	-	-	-		1,006
9190 61 00	BLUETOOTH ADAPTER (optional) Bluetooth-adapter for 9190 N1 for wireless function change and maintenance, incl. free app for iOS and Android, suitable for smartphones and tablets	Pro Detect 2	-	-	-		0,03
9190 57 00	ADAPTER FOR MAINS POWER SUPPLY CONNECTION (optional) recommendation: to install with power supply unit 9190 N1 00	Pro Detect 2	-	-	-		0,038
9221 85 00	URINAL INSTALLATION SYSTEM FOR PRODETECT 525 x 1120 x 80 mm For further ViConnect models, see pages 368-379		-	-	-	10	7,15
9219 89 00	URINAL INSTALLATION SYSTEM 525 x 1120 x 98 mm For further ViConnect models, see pages 368-379		-	-	-		8,05

XX = Colour code to be indicated

R1 = White Alpin CeramicPlus, RW = Stone White CeramicPlus

















FINION

Width in mm		Finion									
											
		4364 4L/4C	4168 6L/6C	4143 61	4142 61/64	4168 8L/8C	4168 1L/1H/1B	4139 DG/DC	4164 81/83/84	4164 A1/A2/A3/AB	4164 C1/C2/C3/CB
800	washbasin on the middle 	F08Z/G08Z (120)	F09Z/G09Z (120)	F22Z/G22Z (123) F63Z/G63Z (126)	F34Z/G34Z (129)						
	1000	washbasin on the middle 		F10Z/G10Z (119)	F23Z/G23Z (123) F64Z/G64Z (126)	F35Z/G35Z (129)	F10Z/G10Z (119)				
	washbasin on the middle 		F11Z/G11Z (120)	F24Z/G24Z (123) F65Z/G65Z (126)	F36Z/G36Z (129)	F11Z/G11Z (120)					
1200	washbasin on the middle 		F12Z/G12Z (120)	F25Z/G25Z (123) F66Z/G66Z (126)	F37Z/G37Z (129)	F12Z/G12Z (120)					
	washbasin on the middle 		F13Z/G13Z (118)	F26Z/G26Z (121) F67Z/G67Z (124)	F38Z/G38Z (127)	F13Z/G13Z (118)	F13Z/G13Z (118)				
	washbasin on right 		F14Z/G14Z (119)	F27Z/G27Z (122) F68Z/G68Z (125)	F39Z/G39Z (128)						
	washbasin on left 		F15Z/G15Z (119)	F28Z/G28Z (122) F69Z/G69Z (125)	F40Z/G40Z (128)						
	washbasin on the middle 		F16Z/G16Z (118)	F29Z/G29Z (122) F70Z/G70Z (125)	F41Z/G41Z (128)	F16Z/G16Z (118)	F16Z/G16Z (118)				
1600	washbasin on the middle 		F17Z/G17Z (119)	F30Z/G30Z (122) F71Z/G71Z (125)	F42Z/G42Z (128)	F17Z/G17Z (119)	F17Z/G17Z (119)				
	for 2 washbasins 		F18Z/G18Z (117)	F31Z/G31Z (121) F72Z/G72Z (124)	F43Z/G43Z (127)						
	washbasin on the middle 		F19Z/G19Z (118)	F32Z/G32Z (121) F73Z/G73Z (124)	F44Z/G44Z (127)	F19Z/G19Z (118)	F19Z/G19Z (118)	F20Z/G20Z (117)			
	washbasin on the middle 		F21Z/G21Z (118)	F33Z/G33Z (121) F74Z/G74Z (124)	F45Z/G45Z (127)	F21Z/G21Z (118)	F21Z/G21Z (118)				



















FINION

FINION

Combination options for Finion furniture with Finion washbasins

Width in mm		Finion									
											
		4364 4L/4C	4168 6L/6C	4143 61	4142 61/64	4168 8L/8C	4168 1L/1H/1B	4139 DG/DC	4164 81/83/84	4164 A1/A2/A3/AB	4164 C1/C2/C3/CB
800	- 								F010/G010 (117)		
1000	- 									F020/G020 (116)	
	- 									F030/G030 (116)	
	- 									F040/G040 (116)	
1200	- 										F050/G050 (115)
	- 										F060/G060 (115)
	- 										F070/G070 (116)





















FINION

			Memento 2.0					
								
			4A22 5G/5L*/5F	4A22 6G/6L*/6F	4A22 8G/8L*/8F	4A22 1G/1H*/1F/1K	4A22 CL/CH*/CG/CF	4A07 60/61*
800	washbasin on the middle		F08Z/G08Z (120)	F09Z/G09Z (120)			F34Z/G34Z (129)	
	washbasin on the middle			F10Z/G10Z (119)	F10Z/G10Z (119)		F35Z/G35Z (129)	
	washbasin on the middle			F11Z/G11Z (120)	F11Z/G11Z (120)		F36Z/G36Z (129)	
1000	washbasin on the middle			F12Z/G12Z (120)	F12Z/G12Z (120)		F37Z/G37Z (129)	
	washbasin on the middle			F13Z/G13Z (118)	F13Z/G13Z (118)	F13Z/G13Z (118)	F38Z/G38Z (127)	
	washbasin on right			F14Z/G14Z (119)			F39Z/G39Z (128)	
	washbasin on left			F15Z/G15Z (119)			F40Z/G40Z (128)	
	washbasin on the middle			F16Z/G16Z (118)	F16Z/G16Z (118)	F16Z/G16Z (118)	F41Z/G41Z (128)	
1200	washbasin on the middle			F17Z/G17Z (119)	F17Z/G17Z (119)	F17Z/G17Z (119)	F42Z/G42Z (128)	
	for 2 washbasins			F18Z/G18Z (117)			F43Z/G43Z (127)	
	washbasin on the middle			F19Z/G19Z (118)	F19Z/G19Z (118)	F19Z/G19Z (118)	F44Z/G44Z (127)	
1600	washbasin on the middle			F21Z/G21Z (118)	F21Z/G21Z (118)	F21Z/G21Z (118)	F45Z/G45Z (127)	
	washbasin on the middle							

* also available with ViFlow

FINION

Combination options for Finion furniture with washbasins from different collections

Width in mm			Artis				Collaro			
										
			4178 41	4179 43	4198 61	4172 58	4A18 40	4A21 38	4A19 56	4A20 56
800	washbasin on the middle		F99Z/G99Z (138)	F87Z/G87Z (135) F99Z/G99Z (138)	F87Z/G87Z (135) F99Z/G99Z (138)	F75Z/G75Z (132) F99Z/G99Z (138)	F87Z/G87Z (135) F99Z/G99Z (138)	F75Z/G75Z (132) F99Z/G99Z (138)	F75Z/G75Z (132) F99Z/G99Z (138)	F75Z/G75Z (132) F99Z/G99Z (138)
1000	washbasin on the middle		FA0Z/GA0Z (138)	F88Z/G88Z (135) FA0Z/GA0Z (138)	F88Z/G88Z (135) FA0Z/GA0Z (138)	F76Z/G76Z (132) FA0Z/GA0Z (138)	F88Z/G88Z (135) FA0Z/GA0Z (138)	F76Z/G76Z (132) FA0Z/GA0Z (138)	F76Z/G76Z (132) FA0Z/GA0Z (138)	F76Z/G76Z (132) FA0Z/GA0Z (138)
	washbasin on the middle		FA1Z/GA1Z (138)	F89Z/G89Z (135) FA1Z/GA1Z (138)	F89Z/G89Z (135) FA1Z/GA1Z (138)	F77Z/G77Z (132) FA1Z/GA1Z (138)	F89Z/G89Z (135) FA1Z/GA1Z (138)	F77Z/G77Z (132) FA1Z/GA1Z (138)	F77Z/G77Z (132) FA1Z/GA1Z (138)	F77Z/G77Z (132) FA1Z/GA1Z (138)
	washbasin on the middle		FA2Z/GA2Z (138)	F90Z/G90Z (135) FA2Z/GA2Z (138)	F90Z/G90Z (135) FA2Z/GA2Z (138)	F78Z/G78Z (132) FA2Z/GA2Z (138)	F90Z/G90Z (135) FA2Z/GA2Z (138)	F78Z/G78Z (132) FA2Z/GA2Z (138)	F78Z/G78Z (132) FA2Z/GA2Z (138)	F78Z/G78Z (132) FA2Z/GA2Z (138)
1200	washbasin on the middle		FA3Z/GA3Z (136)	F91Z/G91Z (133) FA3Z/GA3Z (136)	F91Z/G91Z (133) FA3Z/GA3Z (136)	F79Z/G79Z (130) FA3Z/GA3Z (136)	F91Z/G91Z (133) FA3Z/GA3Z (136)	F79Z/G79Z (130) FA3Z/GA3Z (136)	F79Z/G79Z (130) FA3Z/GA3Z (136)	F79Z/G79Z (130) FA3Z/GA3Z (136)
	washbasin on right		FA4Z/GA4Z (137)	F92Z/G92Z (134) FA4Z/GA4Z (137)	F92Z/G92Z (134) FA4Z/GA4Z (137)	F80Z/G80Z (131) FA4Z/GA4Z (137)	F92Z/G92Z (134) FA4Z/GA4Z (137)	F80Z/G80Z (131) FA4Z/GA4Z (137)	F80Z/G80Z (131) FA4Z/GA4Z (137)	F80Z/G80Z (131) FA4Z/GA4Z (137)
	washbasin on left		FA5Z/GA5Z (137)	F93Z/G93Z (134) FA5Z/GA5Z (137)	F93Z/G93Z (134) FA5Z/GA5Z (137)	F81Z/G81Z (131) FA5Z/GA5Z (137)	F93Z/G93Z (134) FA5Z/GA5Z (137)	F81Z/G81Z (131) FA5Z/GA5Z (137)	F81Z/G81Z (131) FA5Z/GA5Z (137)	F81Z/G81Z (131) FA5Z/GA5Z (137)
	washbasin on the middle		FA6Z/GA6Z (137)	F94Z/G94Z (134) FA6Z/GA6Z (137)	F94Z/G94Z (134) FA6Z/GA6Z (137)	F82Z/G82Z (131) FA6Z/GA6Z (137)	F94Z/G94Z (134) FA6Z/GA6Z (137)	F82Z/G82Z (131) FA6Z/GA6Z (137)	F82Z/G82Z (131) FA6Z/GA6Z (137)	F82Z/G82Z (131) FA6Z/GA6Z (137)
	washbasin on the middle		FA7Z/GA7Z (137)	F95Z/G95Z (134) FA7Z/GA7Z (137)	F95Z/G95Z (134) FA7Z/GA7Z (137)	F83Z/G83Z (131) FA7Z/GA7Z (137)	F95Z/G95Z (134) FA7Z/GA7Z (137)	F83Z/G83Z (131) FA7Z/GA7Z (137)	F83Z/G83Z (131) FA7Z/GA7Z (137)	F83Z/G83Z (131) FA7Z/GA7Z (137)
1600	for 2 washbasins		FA8Z/GA8Z (136)	F96Z/G96Z (133) FA8Z/GA8Z (136)	F96Z/G96Z (133) FA8Z/GA8Z (136)	F84Z/G84Z (130) FA8Z/GA8Z (136)	F96Z/G96Z (133) FA8Z/GA8Z (136)	F84Z/G84Z (130) FA8Z/GA8Z (136)	F84Z/G84Z (130) FA8Z/GA8Z (136)	F84Z/G84Z (130) FA8Z/GA8Z (136)
	washbasin on the middle		FA9Z/GA9Z (136)	F97Z/G97Z (133) FA9Z/GA9Z (136)	F97Z/G97Z (133) FA9Z/GA9Z (136)	F85Z/G85Z (130) FA9Z/GA9Z (136)	F97Z/G97Z (133) FA9Z/GA9Z (136)	F85Z/G85Z (130) FA9Z/GA9Z (136)	F85Z/G85Z (130) FA9Z/GA9Z (136)	F85Z/G85Z (130) FA9Z/GA9Z (136)
	washbasin on the middle		FD0Z/GD0Z (136)	F98Z/G98Z (133) FD0Z/GD0Z (136)	F98Z/G98Z (133) FD0Z/GD0Z (136)	F86Z/G86Z (130) FD0Z/GD0Z (136)	F98Z/G98Z (133) FD0Z/GD0Z (136)	F86Z/G86Z (130) FD0Z/GD0Z (136)	F86Z/G86Z (130) FD0Z/GD0Z (136)	F86Z/G86Z (130) FD0Z/GD0Z (136)

FINION

FINION

€ excl. VAT

Registered design

Produced to order (Please note that it is not always possible to cancel or change orders!), The washbasins are to be ordered separately.





Express Delivery

These products are always in stock.

- Front:**
 painted MDF in HB, HG, HH, GF, GJ, GK, GM, MT, PD, PH (16 mm)
 veneered chipboard in GN, PC (16 mm)
 horizontal grain in GN, PC
 interior colour Anthracite
- Body:**
 painted MDF in HB, HG, HH, GF, GJ, GK, GM, MT, PD, PH (8 mm)
 veneered chipboard in GN, PC (8 mm)
 horizontal grain in GN, PC
- Interior body:**
 direct-laminated chipboard in anthracite
- Washbasin countertop:**
 satin-finish float glass for Black Matt, painted on rear (12 mm)
 Optiwhite glass for White Matt painted on rear (12 mm)
- Drawers:**
 Slip-resistant base
 Push-to-open feature
 SoftClosing feature
- Doors:**
 Push-to-open feature
 SoftClosing feature
- Interior compartments :**
 adjustable glass partitions (8 mm)
 accessory boxes made of grey translucent plastic
- Shelf element:**
 painted MDF in HB, HF, HG, HH, GF, GJ, GK, GM, MT, PD, PH (16 mm)
 veneered MDF in GN, PC (16 mm)
 continuous grain in GN, PC
- Mirrors:**
 mirror (5 mm) on a frame
 available with sound system with wireless transmission
 Can be combined with all Bluetooth-compatible devices, such as MP3 players and smart-phones
 Supply voltage: 100...240 VAC
 Loudspeaker outputs: 2 x 10 W (stereo)
 Loudspeaker impedance: channel L/R: 2 x 4 Ohm
 SUB: 8 Ohm (2.1 sound system)
 Frequency range: 100-18.000 Hz
 Bluetooth standards: Bluetooth CSR 3.0
 Maximum distance between transmitter and receiver: 10 m
- Mirror frame:**
 60 mm x 40 mm aluminium frame (anodised E6/EV1)
- Lighting:**
 integrated LED lighting
 continuously dimmable
 freely-adjustable light colour from DaylightWhite (6500 kelvin) to WarmWhite (2700 kelvin)
 With remote control
 Memory feature - The lighting readjusts to the intensity and colour temperature that were set before the power was switched off.
 loose mains connection

Please note:

Models with glass panels without holes for tap fittings may have a longer delivery period.
 A control unit is needed to operate the lighting in the furniture and mirror. This is not included in the scope of delivery and must be ordered separately under the following article number: G999 02 00. Only one control unit is required per bathroom.
 For further information such as tap fitting positions, installation and fastening dimensions etc. please see the technical drawings.
 The washbasin clippings shown are representative of all washbasin combination options.
 Real wood and real wood veneer are natural products. Deviations in colour, structure, grain or small knots and shrinkage are not quality defects, but proof of the naturalness of the material.

	ACCESSORIES PACKAGE FINION			
Equipped with	1x wide glass drawer divider 3x narrow glass drawer divider 1x accessory box S 1x accessory box M			
	VANITY UNIT	VANITY UNIT	VANITY UNIT	VANITY UNIT
				
Article number	F050 00 XX	G050 00 XX	F060 YY XX	G060 YY XX
Dimensions (w x h x d)	1196 x 591 x 498 mm	1196 x 591 x 498 mm	1196 x 591 x 498 mm	1196 x 591 x 498 mm
Version	washbasin on the middle	with wall lighting washbasin on the middle	with shelf unit (illuminated) washbasin on the middle	with shelf unit (illuminated), with wall lighting washbasin on the middle
For combination with	Finion 4164 C1/C2/C3/CB	Finion 4164 C1/C2/C3/CB	Finion 4164 C1/C2/C3/CB	Finion 4164 C1/C2/C3/CB
Lighting	-	LED lighting Lighting 2x LED / 4,2 W	LED lighting Lighting 1x LED / 2,3 W	LED lighting Lighting 1x LED / 2,3 W, 2x LED / 4,2 W
Equipped with	2x Accessories package Finion 4x pull-out compartment with non-slip mat	2x Accessories package Finion 4x pull-out compartment with non-slip mat	1x Accessories package Finion 3x pull-out compartment with non-slip mat	1x Accessories package Finion 3x pull-out compartment with non-slip mat
Note on standard	-	IP 44	IP 44	IP 44
Installation	wall-mounted	wall-mounted	wall-mounted	wall-mounted
Scope of delivery	fastening set included	fastening set included	fastening set included	fastening set included
All colour combinations				

To see how the article number is structured, refer to page 102

YY = Insert shelf colour
 GF = Glossy White Lacquer, GJ = Light Grey Matt Lacquer, GK = Anthracite Matt Lacquer, GM = Olive Matt Lacquer, HB = Peony Matt Lacquer, HF = Gold Matt Lacquer, HG = Midnight Blue Matt Lacquer, HH = Sand Matt Lacquer, MT = White Matt Lacquer, PD = Black Matt Lacquer, PH = Glossy Black Lacquer, GN = Walnut Veneer, PC = Oak Veneer

XX = Insert front and body colour
 GF = Glossy White Lacquer, GJ = Light Grey Matt Lacquer, GK = Anthracite Matt Lacquer, GM = Olive Matt Lacquer, HB = Peony Matt Lacquer, HG = Midnight Blue Matt Lacquer, HH = Sand Matt Lacquer, MT = White Matt Lacquer, PD = Black Matt Lacquer, PH = Glossy Black Lacquer, GN = Walnut Veneer, PC = Oak Veneer

Z = Insert colour code for cover panels
 1 = Glass White Matt, 2 = Glass Black Matt

FINION

€ excl. VAT

Registered design

Produced to order (Please note that it is not always possible to cancel or change orders!), The washbasins are to be ordered separately.

Express Delivery These products are always in stock.

	VANITY UNIT	VANITY UNIT	VANITY UNIT	VANITY UNIT
Article number	F070 YY XX	G070 YY XX	F020 00 XX	G020 00 XX
Dimensions (w x h x d)	1196 x 591 x 498 mm	1196 x 591 x 498 mm	996 x 591 x 498 mm	996 x 591 x 498 mm
Version	with shelf unit (illuminated) washbasin on the middle	with shelf unit (illuminated), with wall lighting washbasin on the middle	washbasin on the middle	with wall lighting washbasin on the middle
For combination with	Finion 4164 C1/C2/C3/CB	Finion 4164 C1/C2/C3/CB	Finion 4164 A1/A2/A3/AB	Finion 4164 A1/A2/A3/AB
Lighting	LED lighting Lighting 1x LED / 2,3 W	LED lighting Lighting 1x LED / 2,3 W, 2x LED / 4,2 W	-	LED lighting Lighting 2x LED / 4,2 W
Equipped with	1x Accessories package Finion 3x pull-out compartment with non-slip mat	1x Accessories package Finion 3x pull-out compartment with non-slip mat	1x Accessories package Finion 2x pull-out compartment with non-slip mat	1x Accessories package Finion 2x pull-out compartment with non-slip mat
Note on standard	IP 44	IP 44	-	IP 44
Installation	wall-mounted	wall-mounted	wall-mounted	wall-mounted
Scope of delivery	fastening set included	fastening set included	fastening set included	fastening set included
All colour combinations				

	VANITY UNIT	VANITY UNIT	VANITY UNIT	VANITY UNIT
Article number	F030 YY XX	G030 YY XX	F040 YY XX	G040 YY XX
Dimensions (w x h x d)	996 x 591 x 498 mm	996 x 591 x 498 mm	996 x 591 x 498 mm	996 x 591 x 498 mm
Version	with shelf unit (illuminated) washbasin on the middle	with shelf unit (illuminated), with wall lighting washbasin on the middle	with shelf unit (illuminated) washbasin on the middle	with shelf unit (illuminated), with wall lighting washbasin on the middle
For combination with	Finion 4164 A1/A2/A3/AB	Finion 4164 A1/A2/A3/AB	Finion 4164 A1/A2/A3/AB	Finion 4164 A1/A2/A3/AB
Lighting	LED lighting Lighting 1x LED / 2,3 W	LED lighting Lighting 1x LED / 2,3 W, 2x LED / 4,2 W	LED lighting Lighting 1x LED / 2,3 W	LED lighting Lighting 1x LED / 2,3 W, 2x LED / 4,2 W
Equipped with	1x Accessories package Finion 2x pull-out compartment with non-slip mat	1x Accessories package Finion 2x pull-out compartment with non-slip mat	1x Accessories package Finion 2x pull-out compartment with non-slip mat	1x Accessories package Finion 2x pull-out compartment with non-slip mat
Note on standard	IP 44	IP 44	IP 44	IP 44
Installation	wall-mounted	wall-mounted	wall-mounted	wall-mounted
Scope of delivery	fastening set included	fastening set included	fastening set included	fastening set included
All colour combinations				

To see how the article number is structured, refer to page 102

YY = Insert shelf colour
 GF = Glossy White Lacquer, GJ = Light Grey Matt Lacquer, GK = Anthracite Matt Lacquer, GM = Olive Matt Lacquer, HB = Peony Matt Lacquer, HF = Gold Matt Lacquer, HG = Midnight Blue Matt Lacquer, HH = Sand Matt Lacquer, MT = White Matt Lacquer, PD = Black Matt Lacquer, PH = Glossy Black Lacquer, GN = Walnut Veneer, PC = Oak Veneer

XX = Insert front and body colour
 GF = Glossy White Lacquer, GJ = Light Grey Matt Lacquer, GK = Anthracite Matt Lacquer, GM = Olive Matt Lacquer, HB = Peony Matt Lacquer, HG = Midnight Blue Matt Lacquer, HH = Sand Matt Lacquer, MT = White Matt Lacquer, PD = Black Matt Lacquer, PH = Glossy Black Lacquer, GN = Walnut Veneer, PC = Oak Veneer

Z = Insert colour code for cover panels
 1 = Glass White Matt, 2 = Glass Black Matt

FINION

FINION

€ excl. VAT



Registered design

Produced to order (Please note that it is not always possible to cancel or change orders!), The washbasins are to be ordered separately.

Express Delivery

These products are always in stock.

	VANITY UNIT	VANITY UNIT
		
Article number	F010 00 XX	G010 00 XX
Dimensions (w x h x d)	796 x 591 x 498 mm	796 x 591 x 498 mm
Version	washbasin on the middle	with wall lighting washbasin on the middle
For combination with	Finion 4164 81/83/84	Finion 4164 81/83/84
Lighting	-	LED lighting Lighting 2x LED / 4,2 W
Equipped with	1x Accessories package Finion 2x pull-out compartment with non-slip mat	1x Accessories package Finion 2x pull-out compartment with non-slip mat
Note on standard	-	IP 44
Installation	wall-mounted	wall-mounted
Scope of delivery	fastening set included	fastening set included
All colour combinations		

	VANITY UNIT	VANITY UNIT	VANITY UNIT	VANITY UNIT
				
Article number	F18Z 00 XX	G18Z 00 XX	F20Z 00 XX	G20Z 00 XX
Dimensions (w x h x d)	1600 x 603 x 501 mm	1600 x 603 x 501 mm	1600 x 603 x 501 mm	1600 x 603 x 501 mm
Version	for 2 washbasins	with wall lighting for 2 washbasins	washbasin on the middle	with wall lighting washbasin on the middle
For combination with	Finion 4168 6C/6L Memento 2.0 4A22 6F/6G/6L	Finion 4168 6C/6L Memento 2.0 4A22 6F/6G/6L	Finion 4139 DC/DG	Finion 4139 DC/DG
Lighting	-	LED lighting Lighting 2x LED / 4,2 W	-	LED lighting Lighting 2x LED / 4,2 W
Equipped with	2x Accessories package Finion 4x pull-out compartment with non-slip mat	2x Accessories package Finion 4x pull-out compartment with non-slip mat	2x Accessories package Finion 4x pull-out compartment with non-slip mat	2x Accessories package Finion 4x pull-out compartment with non-slip mat
Note on standard	-	IP 44	-	IP 44
Installation	wall-mounted	wall-mounted	wall-mounted	wall-mounted
Scope of delivery	fastening set included	fastening set included	fastening set included	fastening set included
All colour combinations				

To see how the article number is structured, refer to page 102

YY = Insert shelf colour

GF = Glossy White Lacquer, GJ = Light Grey Matt Lacquer, GK = Anthracite Matt Lacquer, GM = Olive Matt Lacquer, HB = Peony Matt Lacquer, HF = Gold Matt Lacquer, HG = Midnight Blue Matt Lacquer, HH = Sand Matt Lacquer, MT = White Matt Lacquer, PD = Black Matt Lacquer, PH = Glossy Black Lacquer, GN = Walnut Veneer, PC = Oak Veneer

XX = Insert front and body colour

GF = Glossy White Lacquer, GJ = Light Grey Matt Lacquer, GK = Anthracite Matt Lacquer, GM = Olive Matt Lacquer, HB = Peony Matt Lacquer, HG = Midnight Blue Matt Lacquer, HH = Sand Matt Lacquer, MT = White Matt Lacquer, PD = Black Matt Lacquer, PH = Glossy Black Lacquer, GN = Walnut Veneer, PC = Oak Veneer

Z = Insert colour code for cover panels

1 = Glass White Matt, 2 = Glass Black Matt

FINION

€ excl. VAT

Registered design

Produced to order (Please note that it is not always possible to cancel or change orders!), The washbasins are to be ordered separately.

Express Delivery These products are always in stock.

	VANITY UNIT	VANITY UNIT	VANITY UNIT	VANITY UNIT
Article number	F21Z YY XX	G21Z YY XX	F19Z 00 XX	G19Z 00 XX
Dimensions (w x h x d)	1600 x 603 x 501 mm	1600 x 603 x 501 mm	1600 x 603 x 501 mm	1600 x 603 x 501 mm
Version	with shelf unit (illuminated) washbasin on the middle	with shelf unit (illuminated), with wall lighting washbasin on the middle	washbasin on the middle	with wall lighting washbasin on the middle
For combination with	Finion 4168 1B/1H/1L, 4168 8C/8L, 4168 6C/6L Memento 2.0 4A22 CF/CG/CH/CL, 4A22 1F/1G/1H/1K, 4A22 8F/8G/8L, 4A22 6F/6G/6L	Finion 4168 1B/1H/1L, 4168 8C/8L, 4168 6C/6L Memento 2.0 4A22 CF/CG/CH/CL, 4A22 1F/1G/1H/1K, 4A22 8F/8G/8L, 4A22 6F/6G/6L	Finion 4168 1B/1H/1L, 4168 8C/8L, 4168 6C/6L Memento 2.0 4A22 CF/CG/CH/CL, 4A22 1F/1G/1H/1K, 4A22 8F/8G/8L, 4A22 6F/6G/6L	Finion 4168 1B/1H/1L, 4168 8C/8L, 4168 6C/6L Memento 2.0 4A22 CF/CG/CH/CL, 4A22 1F/1G/1H/1K, 4A22 8F/8G/8L, 4A22 6F/6G/6L
Lighting	LED lighting Lighting 2x LED / 2,3 W	LED lighting Lighting 2x LED / 2,3 W, 2x LED / 4,2 W	-	LED lighting Lighting 2x LED / 4,2 W
Equipped with	1x Accessories package Finion 4x pull-out compartment with non-slip mat	1x Accessories package Finion 4x pull-out compartment with non-slip mat	2x Accessories package Finion 4x pull-out compartment with non-slip mat	2x Accessories package Finion 4x pull-out compartment with non-slip mat
Note on standard	IP 44	IP 44	-	IP 44
Installation	wall-mounted	wall-mounted	wall-mounted	wall-mounted
Scope of delivery	fastening set included	fastening set included	fastening set included	fastening set included
All colour combinations				

	VANITY UNIT	VANITY UNIT	VANITY UNIT	VANITY UNIT
Article number	F13Z 00 XX	G13Z 00 XX	F16Z YY XX	G16Z YY XX
Dimensions (w x h x d)	1200 x 603 x 501 mm	1200 x 603 x 501 mm	1200 x 603 x 501 mm	1200 x 603 x 501 mm
Version	washbasin on the middle	with wall lighting washbasin on the middle	with shelf unit (illuminated) washbasin on the middle	with shelf unit (illuminated), with wall lighting washbasin on the middle
For combination with	Finion 4168 1B/1H/1L, 4168 8C/8L, 4168 6C/6L Memento 2.0 4A22 1F/1G/1H/1K, 4A22 8F/8G/8L, 4A22 6F/6G/6L	Finion 4168 1B/1H/1L, 4168 8C/8L, 4168 6C/6L Memento 2.0 4A22 1F/1G/1H/1K, 4A22 8F/8G/8L, 4A22 6F/6G/6L	Finion 4168 1B/1H/1L, 4168 8C/8L, 4168 6C/6L Memento 2.0 4A22 1F/1G/1H/1K, 4A22 8F/8G/8L, 4A22 6F/6G/6L	Finion 4168 1B/1H/1L, 4168 8C/8L, 4168 6C/6L Memento 2.0 4A22 1F/1G/1H/1K, 4A22 8F/8G/8L, 4A22 6F/6G/6L
Lighting	-	LED lighting Lighting 2x LED / 4,2 W	LED lighting Lighting 1x LED / 2,3 W	LED lighting Lighting 1x LED / 2,3 W, 2x LED / 4,2 W
Equipped with	2x Accessories package Finion 4x pull-out compartment with non-slip mat	2x Accessories package Finion 4x pull-out compartment with non-slip mat	1x Accessories package Finion 3x pull-out compartment with non-slip mat	1x Accessories package Finion 3x pull-out compartment with non-slip mat
Note on standard	-	IP 44	IP 44	IP 44
Installation	wall-mounted	wall-mounted	wall-mounted	wall-mounted
Scope of delivery	fastening set included	fastening set included	fastening set included	fastening set included
All colour combinations				

To see how the article number is structured, refer to page 102

YY = Insert shelf colour
GF = Glossy White Lacquer, GJ = Light Grey Matt Lacquer, GK = Anthracite Matt Lacquer, GM = Olive Matt Lacquer, HB = Peony Matt Lacquer, HF = Gold Matt Lacquer, HG = Midnight Blue Matt Lacquer, HH = Sand Matt Lacquer, MT = White Matt Lacquer, PD = Black Matt Lacquer, PH = Glossy Black Lacquer, GN = Walnut Veneer, PC = Oak Veneer

XX = Insert front and body colour
GF = Glossy White Lacquer, GJ = Light Grey Matt Lacquer, GK = Anthracite Matt Lacquer, GM = Olive Matt Lacquer, HB = Peony Matt Lacquer, HG = Midnight Blue Matt Lacquer, HH = Sand Matt Lacquer, MT = White Matt Lacquer, PD = Black Matt Lacquer, PH = Glossy Black Lacquer, GN = Walnut Veneer, PC = Oak Veneer

Z = Insert colour code for cover panels
1 = Glass White Matt, 2 = Glass Black Matt

FINION

FINION

€ excl. VAT

Registered design

Produced to order (Please note that it is not always possible to cancel or change orders!), The washbasins are to be ordered separately.

Express Delivery These products are always in stock.

	VANITY UNIT	VANITY UNIT	VANITY UNIT	VANITY UNIT
Article number	F17Z YY XX	G17Z YY XX	F15Z YY XX	G15Z YY XX
Dimensions (w x h x d)	1200 x 603 x 501 mm	1200 x 603 x 501 mm	1200 x 603 x 501 mm	1200 x 603 x 501 mm
Version	with shelf unit (illuminated) washbasin on the middle	with shelf unit (illuminated), with wall lighting washbasin on the middle	with shelf unit (illuminated) washbasin on left	with shelf unit (illuminated), with wall lighting washbasin on left
For combination with	Finion 4168 1B/1H/1L, 4168 8C/8L, 4168 6C/6L Memento 2.0 4A22 1F/1G/1H/1K, 4A22 8F/8G/8L, 4A22 6F/6G/6L	Finion 4168 1B/1H/1L, 4168 8C/8L, 4168 6C/6L Memento 2.0 4A22 1F/1G/1H/1K, 4A22 8F/8G/8L, 4A22 6F/6G/6L	Finion 4168 6C/6L Memento 2.0 4A22 6F/6G/6L	Finion 4168 6C/6L Memento 2.0 4A22 6F/6G/6L
Lighting	LED lighting Lighting 1x LED / 2,3 W	LED lighting Lighting 1x LED / 2,3 W, 2x LED / 4,2 W	LED lighting Lighting 1x LED / 2,3 W	LED lighting Lighting 1x LED / 2,3 W, 2x LED / 4,2 W
Equipped with	1x Accessories package Finion 3x pull-out compartment with non-slip mat	1x Accessories package Finion 3x pull-out compartment with non-slip mat	1x Accessories package Finion 3x pull-out compartment with non-slip mat	1x Accessories package Finion 3x pull-out compartment with non-slip mat
Note on standard	IP 44	IP 44	IP 44	IP 44
Installation	wall-mounted	wall-mounted	wall-mounted	wall-mounted
Scope of delivery	fastening set included	fastening set included	fastening set included	fastening set included
All colour combinations				

	VANITY UNIT	VANITY UNIT	VANITY UNIT	VANITY UNIT
Article number	F14Z YY XX	G14Z YY XX	F10Z 00 XX	G10Z 00 XX
Dimensions (w x h x d)	1200 x 603 x 501 mm	1200 x 603 x 501 mm	1000 x 603 x 501 mm	1000 x 603 x 501 mm
Version	with shelf unit (illuminated) washbasin on right	with shelf unit (illuminated), with wall lighting washbasin on right	washbasin on the middle	with wall lighting washbasin on the middle
For combination with	Finion 4168 6C/6L Memento 2.0 4A22 6F/6G/6L	Finion 4168 6C/6L Memento 2.0 4A22 6F/6G/6L	Finion 4168 8C/8L, 4168 6C/6L Memento 2.0 4A22 8F/8G/8L, 4A22 6F/6G/6L	Finion 4168 8C/8L, 4168 6C/6L Memento 2.0 4A22 8F/8G/8L, 4A22 6F/6G/6L
Lighting	LED lighting Lighting 1x LED / 2,3 W	LED lighting Lighting 1x LED / 2,3 W, 2x LED / 4,2 W	-	LED lighting Lighting 2x LED / 4,2 W
Equipped with	1x Accessories package Finion 3x pull-out compartment with non-slip mat	1x Accessories package Finion 3x pull-out compartment with non-slip mat	1x Accessories package Finion 2x pull-out compartment with non-slip mat	1x Accessories package Finion 2x pull-out compartment with non-slip mat
Note on standard	IP 44	IP 44	-	IP 44
Installation	wall-mounted	wall-mounted	wall-mounted	wall-mounted
Scope of delivery	fastening set included	fastening set included	fastening set included	fastening set included
All colour combinations				

To see how the article number is structured, refer to page 102

YY = Insert shelf colour
GF = Glossy White Lacquer, GJ = Light Grey Matt Lacquer, GK = Anthracite Matt Lacquer, GM = Olive Matt Lacquer, HB = Peony Matt Lacquer, HF = Gold Matt Lacquer, HG = Midnight Blue Matt Lacquer, HH = Sand Matt Lacquer, MT = White Matt Lacquer, PD = Black Matt Lacquer, PH = Glossy Black Lacquer, GN = Walnut Veneer, PC = Oak Veneer

XX = Insert front and body colour
GF = Glossy White Lacquer, GJ = Light Grey Matt Lacquer, GK = Anthracite Matt Lacquer, GM = Olive Matt Lacquer, HB = Peony Matt Lacquer, HG = Midnight Blue Matt Lacquer, HH = Sand Matt Lacquer, MT = White Matt Lacquer, PD = Black Matt Lacquer, PH = Glossy Black Lacquer, GN = Walnut Veneer, PC = Oak Veneer

Z = Insert colour code for cover panels
1 = Glass White Matt, 2 = Glass Black Matt

FINION

€ excl. VAT

Registered design

Produced to order (Please note that it is not always possible to cancel or change orders!), The washbasins are to be ordered separately.

Express Delivery

These products are always in stock.

	VANITY UNIT	VANITY UNIT	VANITY UNIT	VANITY UNIT
Article number	F11Z YY XX	G11Z YY XX	F12Z YY XX	G12Z YY XX
Dimensions (w x h x d)	1000 x 603 x 501 mm	1000 x 603 x 501 mm	1000 x 603 x 501 mm	1000 x 603 x 501 mm
Version	with shelf unit (illuminated) washbasin on the middle	with shelf unit (illuminated), with wall lighting washbasin on the middle	with shelf unit (illuminated) washbasin on the middle	with shelf unit (illuminated), with wall lighting washbasin on the middle
For combination with	Finion 4168 8C/8L, 4168 6C/6L Memento 2.0 4A22 8F/8G/8L, 4A22 6F/6G/6L	Finion 4168 8C/8L, 4168 6C/6L Memento 2.0 4A22 8F/8G/8L, 4A22 6F/6G/6L	Finion 4168 8C/8L, 4168 6C/6L Memento 2.0 4A22 8F/8G/8L, 4A22 6F/6G/6L	Finion 4168 8C/8L, 4168 6C/6L Memento 2.0 4A22 8F/8G/8L, 4A22 6F/6G/6L
Lighting	LED lighting Lighting 1x LED / 2,3 W	LED lighting Lighting 1x LED / 2,3 W, 2x LED / 4,2 W	LED lighting Lighting 1x LED / 2,3 W	LED lighting Lighting 1x LED / 2,3 W, 2x LED / 4,2 W
Equipped with	1x Accessories package Finion 2x pull-out compartment with non-slip mat	1x Accessories package Finion 2x pull-out compartment with non-slip mat	1x Accessories package Finion 2x pull-out compartment with non-slip mat	1x Accessories package Finion 2x pull-out compartment with non-slip mat
Note on standard	IP 44	IP 44	IP 44	IP 44
Installation	wall-mounted	wall-mounted	wall-mounted	wall-mounted
Scope of delivery	fastening set included	fastening set included	fastening set included	fastening set included
All colour combinations				

	VANITY UNIT	VANITY UNIT	VANITY UNIT	VANITY UNIT
Article number	F09Z 00 XX	G09Z 00 XX	F08Z 00 XX	G08Z 00 XX
Dimensions (w x h x d)	800 x 603 x 501 mm	800 x 603 x 501 mm	800 x 603 x 501 mm	800 x 603 x 501 mm
Version	washbasin on the middle	with wall lighting washbasin on the middle	washbasin on the middle	with wall lighting washbasin on the middle
For combination with	Finion 4168 6C/6L Memento 2.0 4A22 6F/6G/6L	Finion 4168 6C/6L Memento 2.0 4A22 6F/6G/6L	Finion 4364 4C/4L Memento 2.0 4A22 5F/5G/5L	Finion 4364 4C/4L Memento 2.0 4A22 5F/5G/5L
Lighting	-	LED lighting Lighting 2x LED / 4,2 W	-	LED lighting Lighting 2x LED / 4,2 W
Equipped with	1x Accessories package Finion 2x pull-out compartment with non-slip mat	1x Accessories package Finion 2x pull-out compartment with non-slip mat	1x Accessories package Finion 2x pull-out compartment with non-slip mat	1x Accessories package Finion 2x pull-out compartment with non-slip mat
Note on standard	-	IP 44	-	IP 44
Installation	wall-mounted	wall-mounted	wall-mounted	wall-mounted
Scope of delivery	fastening set included	fastening set included	fastening set included	fastening set included
All colour combinations				

To see how the article number is structured, refer to page 102

YY = Insert shelf colour
 GF = Glossy White Lacquer, GJ = Light Grey Matt Lacquer, GK = Anthracite Matt Lacquer, GM = Olive Matt Lacquer, HB = Peony Matt Lacquer, HF = Gold Matt Lacquer, HG = Midnight Blue Matt Lacquer, HH = Sand Matt Lacquer, MT = White Matt Lacquer, PD = Black Matt Lacquer, PH = Glossy Black Lacquer, GN = Walnut Veneer, PC = Oak Veneer

XX = Insert front and body colour
 GF = Glossy White Lacquer, GJ = Light Grey Matt Lacquer, GK = Anthracite Matt Lacquer, GM = Olive Matt Lacquer, HB = Peony Matt Lacquer, HG = Midnight Blue Matt Lacquer, HH = Sand Matt Lacquer, MT = White Matt Lacquer, PD = Black Matt Lacquer, PH = Glossy Black Lacquer, GN = Walnut Veneer, PC = Oak Veneer

Z = Insert colour code for cover panels
 1 = Glass White Matt, 2 = Glass Black Matt

FINION

€ excl. VAT

Registered design

Produced to order (Please note that it is not always possible to cancel or change orders!), The washbasins are to be ordered separately.

Express Delivery These products are always in stock.

	VANITY UNIT	VANITY UNIT	VANITY UNIT	VANITY UNIT
Article number	F31Z 00 XX	G31Z 00 XX	F32Z 00 XX	G32Z 00 XX
Dimensions (w x h x d)	1600 x 603 x 501 mm	1600 x 603 x 501 mm	1600 x 603 x 501 mm	1600 x 603 x 501 mm
Version	with drilled tap holes for 2 washbasins	with wall lighting, with drilled tap holes for 2 washbasins	with drilled tap holes washbasin on the middle	with wall lighting, with drilled tap holes washbasin on the middle
For combination with	Finion 4143 61	Finion 4143 61	Finion 4143 61	Finion 4143 61
Lighting	-	LED lighting Lighting 2x LED / 4,2 W	-	LED lighting Lighting 2x LED / 4,2 W
Equipped with	2x Accessories package Finion 4x pull-out compartment with non-slip mat	2x Accessories package Finion 4x pull-out compartment with non-slip mat	2x Accessories package Finion 4x pull-out compartment with non-slip mat	2x Accessories package Finion 4x pull-out compartment with non-slip mat
Note on standard	-	IP 44	-	IP 44
Installation	wall-mounted	wall-mounted	wall-mounted	wall-mounted
Scope of delivery	fastening set included	fastening set included	fastening set included	fastening set included
All colour combinations				

	VANITY UNIT	VANITY UNIT	VANITY UNIT	VANITY UNIT
Article number	F33Z YY XX	G33Z YY XX	F26Z 00 XX	G26Z 00 XX
Dimensions (w x h x d)	1600 x 603 x 501 mm	1600 x 603 x 501 mm	1200 x 603 x 501 mm	1200 x 603 x 501 mm
Version	with shelf unit (illuminated), with drilled tap holes washbasin on the middle	with shelf unit (illuminated), with wall lighting, with drilled tap holes washbasin on the middle	with drilled tap holes washbasin on the middle	with wall lighting, with drilled tap holes washbasin on the middle
For combination with	Finion 4143 61	Finion 4143 61	Finion 4143 61	Finion 4143 61
Lighting	LED lighting Lighting 2x LED / 2,3 W	LED lighting Lighting 2x LED / 2,3 W, 2x LED / 4,2 W	-	LED lighting Lighting 2x LED / 4,2 W
Equipped with	1x Accessories package Finion 4x pull-out compartment with non-slip mat	1x Accessories package Finion 4x pull-out compartment with non-slip mat	2x Accessories package Finion 4x pull-out compartment with non-slip mat	2x Accessories package Finion 4x pull-out compartment with non-slip mat
Note on standard	IP 44	IP 44	-	IP 44
Installation	wall-mounted	wall-mounted	wall-mounted	wall-mounted
Scope of delivery	fastening set included	fastening set included	fastening set included	fastening set included
All colour combinations				

To see how the article number is structured, refer to page 102

YY = Insert shelf colour
 GF = Glossy White Lacquer, GJ = Light Grey Matt Lacquer, GK = Anthracite Matt Lacquer, GM = Olive Matt Lacquer, HB = Peony Matt Lacquer, HF = Gold Matt Lacquer, HG = Midnight Blue Matt Lacquer, HH = Sand Matt Lacquer, MT = White Matt Lacquer, PD = Black Matt Lacquer, PH = Glossy Black Lacquer, GN = Walnut Veneer, PC = Oak Veneer

XX = Insert front and body colour
 GF = Glossy White Lacquer, GJ = Light Grey Matt Lacquer, GK = Anthracite Matt Lacquer, GM = Olive Matt Lacquer, HB = Peony Matt Lacquer, HG = Midnight Blue Matt Lacquer, HH = Sand Matt Lacquer, MT = White Matt Lacquer, PD = Black Matt Lacquer, PH = Glossy Black Lacquer, GN = Walnut Veneer, PC = Oak Veneer

Z = Insert colour code for cover panels
 1 = Glass White Matt, 2 = Glass Black Matt

FINION

€ excl. VAT

Registered design

Produced to order (Please note that it is not always possible to cancel or change orders!), The washbasins are to be ordered separately.

Express Delivery These products are always in stock.

	VANITY UNIT	VANITY UNIT	VANITY UNIT	VANITY UNIT
Article number	F29Z YY XX	G29Z YY XX	F30Z YY XX	G30Z YY XX
Dimensions (w x h x d)	1200 x 603 x 501 mm	1200 x 603 x 501 mm	1200 x 603 x 501 mm	1200 x 603 x 501 mm
Version	with shelf unit (illuminated), with drilled tap holes washbasin on the middle	with shelf unit (illuminated), with wall lighting, with drilled tap holes washbasin on the middle	with shelf unit (illuminated), with drilled tap holes washbasin on the middle	with shelf unit (illuminated), with wall lighting, with drilled tap holes washbasin on the middle
For combination with	Finion 4143 61	Finion 4143 61	Finion 4143 61	Finion 4143 61
Lighting	LED lighting Lighting 1x LED / 2,3 W	LED lighting Lighting 1x LED / 2,3 W, 2x LED / 4,2 W	LED lighting Lighting 1x LED / 2,3 W	LED lighting Lighting 1x LED / 2,3 W, 2x LED / 4,2 W
Equipped with	1x Accessories package Finion 3x pull-out compartment with non-slip mat	1x Accessories package Finion 3x pull-out compartment with non-slip mat	1x Accessories package Finion 3x pull-out compartment with non-slip mat	1x Accessories package Finion 3x pull-out compartment with non-slip mat
Note on standard	IP 44	IP 44	IP 44	IP 44
Installation	wall-mounted	wall-mounted	wall-mounted	wall-mounted
Scope of delivery	fastening set included	fastening set included	fastening set included	fastening set included
All colour combinations				

	VANITY UNIT	VANITY UNIT	VANITY UNIT	VANITY UNIT
Article number	F28Z YY XX	G28Z YY XX	F27Z YY XX	G27Z YY XX
Dimensions (w x h x d)	1200 x 603 x 501 mm	1200 x 603 x 501 mm	1200 x 603 x 501 mm	1200 x 603 x 501 mm
Version	with shelf unit (illuminated), with drilled tap holes washbasin on left	with shelf unit (illuminated), with wall lighting, with drilled tap holes washbasin on left	with shelf unit (illuminated), with drilled tap holes washbasin on right	with shelf unit (illuminated), with wall lighting, with drilled tap holes washbasin on right
For combination with	Finion 4143 61	Finion 4143 61	Finion 4143 61	Finion 4143 61
Lighting	LED lighting Lighting 1x LED / 2,3 W	LED lighting Lighting 1x LED / 2,3 W, 2x LED / 4,2 W	LED lighting Lighting 1x LED / 2,3 W	LED lighting Lighting 1x LED / 2,3 W, 2x LED / 4,2 W
Equipped with	1x Accessories package Finion 3x pull-out compartment with non-slip mat	1x Accessories package Finion 3x pull-out compartment with non-slip mat	1x Accessories package Finion 3x pull-out compartment with non-slip mat	1x Accessories package Finion 3x pull-out compartment with non-slip mat
Note on standard	IP 44	IP 44	IP 44	IP 44
Installation	wall-mounted	wall-mounted	wall-mounted	wall-mounted
Scope of delivery	fastening set included	fastening set included	fastening set included	fastening set included
All colour combinations				

To see how the article number is structured, refer to page 102

YY = Insert shelf colour
 GF = Glossy White Lacquer, GJ = Light Grey Matt Lacquer, GK = Anthracite Matt Lacquer, GM = Olive Matt Lacquer, HB = Peony Matt Lacquer, HF = Gold Matt Lacquer, HG = Midnight Blue Matt Lacquer, HH = Sand Matt Lacquer, MT = White Matt Lacquer, PD = Black Matt Lacquer, PH = Glossy Black Lacquer, GN = Walnut Veneer, PC = Oak Veneer

XX = Insert front and body colour
 GF = Glossy White Lacquer, GJ = Light Grey Matt Lacquer, GK = Anthracite Matt Lacquer, GM = Olive Matt Lacquer, HB = Peony Matt Lacquer, HG = Midnight Blue Matt Lacquer, HH = Sand Matt Lacquer, MT = White Matt Lacquer, PD = Black Matt Lacquer, PH = Glossy Black Lacquer, GN = Walnut Veneer, PC = Oak Veneer

Z = Insert colour code for cover panels
 1 = Glass White Matt, 2 = Glass Black Matt

FINION

€ excl. VAT

Registered design

Produced to order (Please note that it is not always possible to cancel or change orders!), The washbasins are to be ordered separately.

Express Delivery

These products are always in stock.

	VANITY UNIT	VANITY UNIT	VANITY UNIT	VANITY UNIT
Article number	F23Z 00 XX	G23Z 00 XX	F24Z YY XX	G24Z YY XX
Dimensions (w x h x d)	1000 x 603 x 501 mm	1000 x 603 x 501 mm	1000 x 603 x 501 mm	1000 x 603 x 501 mm
Version	with drilled tap holes washbasin on the middle	with wall lighting, with drilled tap holes washbasin on the middle	with shelf unit (illuminated), with drilled tap holes washbasin on the middle	with shelf unit (illuminated), with wall lighting, with drilled tap holes washbasin on the middle
For combination with	Finion 4143 61	Finion 4143 61	Finion 4143 61	Finion 4143 61
Lighting	-	LED lighting Lighting 2x LED / 4,2 W	LED lighting Lighting 1x LED / 2,3 W	LED lighting Lighting 1x LED / 2,3 W, 2x LED / 4,2 W
Equipped with	1x Accessories package Finion 2x pull-out compartment with non-slip mat	1x Accessories package Finion 2x pull-out compartment with non-slip mat	1x Accessories package Finion 2x pull-out compartment with non-slip mat	1x Accessories package Finion 2x pull-out compartment with non-slip mat
Note on standard	-	IP 44	IP 44	IP 44
Installation	wall-mounted	wall-mounted	wall-mounted	wall-mounted
Scope of delivery	fastening set included	fastening set included	fastening set included	fastening set included
All colour combinations				

	VANITY UNIT	VANITY UNIT	VANITY UNIT	VANITY UNIT
Article number	F25Z YY XX	G25Z YY XX	F22Z 00 XX	G22Z 00 XX
Dimensions (w x h x d)	1000 x 603 x 501 mm	1000 x 603 x 501 mm	800 x 603 x 501 mm	800 x 603 x 501 mm
Version	with shelf unit (illuminated), with drilled tap holes washbasin on the middle	with shelf unit (illuminated), with wall lighting, with drilled tap holes washbasin on the middle	with drilled tap holes washbasin on the middle	with wall lighting, with drilled tap holes washbasin on the middle
For combination with	Finion 4143 61	Finion 4143 61	Finion 4143 61	Finion 4143 61
Lighting	LED lighting Lighting 1x LED / 2,3 W	LED lighting Lighting 1x LED / 2,3 W, 2x LED / 4,2 W	-	LED lighting Lighting 2x LED / 4,2 W
Equipped with	1x Accessories package Finion 2x pull-out compartment with non-slip mat	1x Accessories package Finion 2x pull-out compartment with non-slip mat	1x Accessories package Finion 2x pull-out compartment with non-slip mat	1x Accessories package Finion 2x pull-out compartment with non-slip mat
Note on standard	IP 44	IP 44	-	IP 44
Installation	wall-mounted	wall-mounted	wall-mounted	wall-mounted
Scope of delivery	fastening set included	fastening set included	fastening set included	fastening set included
All colour combinations				

To see how the article number is structured, refer to page 102

YY = Insert shelf colour
 GF = Glossy White Lacquer, GJ = Light Grey Matt Lacquer, GK = Anthracite Matt Lacquer, GM = Olive Matt Lacquer, HB = Peony Matt Lacquer, HF = Gold Matt Lacquer, HG = Midnight Blue Matt Lacquer, HH = Sand Matt Lacquer, MT = White Matt Lacquer, PD = Black Matt Lacquer, PH = Glossy Black Lacquer, GN = Walnut Veneer, PC = Oak Veneer

XX = Insert front and body colour
 GF = Glossy White Lacquer, GJ = Light Grey Matt Lacquer, GK = Anthracite Matt Lacquer, GM = Olive Matt Lacquer, HB = Peony Matt Lacquer, HG = Midnight Blue Matt Lacquer, HH = Sand Matt Lacquer, MT = White Matt Lacquer, PD = Black Matt Lacquer, PH = Glossy Black Lacquer, GN = Walnut Veneer, PC = Oak Veneer

Z = Insert colour code for cover panels
 1 = Glass White Matt, 2 = Glass Black Matt









FINION

€ excl. VAT

Registered design

Produced to order (Please note that it is not always possible to cancel or change orders!), The washbasins are to be ordered separately.

Express Delivery These products are always in stock.

	VANITY UNIT	VANITY UNIT	VANITY UNIT	VANITY UNIT
				
Article number	F72Z 00 XX	G72Z 00 XX	F73Z 00 XX	G73Z 00 XX
Dimensions (w x h x d)	1600 x 603 x 501 mm	1600 x 603 x 501 mm	1600 x 603 x 501 mm	1600 x 603 x 501 mm
Version	without drilled tap holes for 2 washbasins	with wall lighting, without drilled tap holes for 2 washbasins	without drilled tap holes washbasin on the middle	with wall lighting, without drilled tap holes washbasin on the middle
For combination with	Finion 4143 61	Finion 4143 61	Finion 4143 61	Finion 4143 61
Lighting	-	LED lighting Lighting 2x LED / 4,2 W	-	LED lighting Lighting 2x LED / 4,2 W
Equipped with	2x Accessories package Finion 4x pull-out compartment with non-slip mat	2x Accessories package Finion 4x pull-out compartment with non-slip mat	2x Accessories package Finion 4x pull-out compartment with non-slip mat	2x Accessories package Finion 4x pull-out compartment with non-slip mat
Note on standard	-	IP 44	-	IP 44
Installation	wall-mounted	wall-mounted	wall-mounted	wall-mounted
Scope of delivery	fastening set included	fastening set included	fastening set included	fastening set included
All colour combinations				
	VANITY UNIT	VANITY UNIT	VANITY UNIT	VANITY UNIT
				
Article number	F74Z YY XX	G74Z YY XX	F67Z 00 XX	G67Z 00 XX
Dimensions (w x h x d)	1600 x 603 x 501 mm	1600 x 603 x 501 mm	1200 x 603 x 501 mm	1200 x 603 x 501 mm
Version	with shelf unit (illuminated), without drilled tap holes washbasin on the middle	with shelf unit (illuminated), with wall lighting, without drilled tap holes washbasin on the middle	without drilled tap holes washbasin on the middle	with wall lighting, without drilled tap holes washbasin on the middle
For combination with	Finion 4143 61	Finion 4143 61	Finion 4143 61	Finion 4143 61
Lighting	LED lighting Lighting 2x LED / 2,3 W	LED lighting Lighting 2x LED / 2,3 W, 2x LED / 4,2 W	-	LED lighting Lighting 2x LED / 4,2 W
Equipped with	1x Accessories package Finion 4x pull-out compartment with non-slip mat	1x Accessories package Finion 4x pull-out compartment with non-slip mat	2x Accessories package Finion 4x pull-out compartment with non-slip mat	2x Accessories package Finion 4x pull-out compartment with non-slip mat
Note on standard	IP 44	IP 44	-	IP 44
Installation	wall-mounted	wall-mounted	wall-mounted	wall-mounted
Scope of delivery	fastening set included	fastening set included	fastening set included	fastening set included
All colour combinations				

FINION

To see how the article number is structured, refer to page 102

YY = Insert shelf colour
 GF = Glossy White Lacquer, GJ = Light Grey Matt Lacquer, GK = Anthracite Matt Lacquer, GM = Olive Matt Lacquer, HB = Peony Matt Lacquer, HF = Gold Matt Lacquer, HG = Midnight Blue Matt Lacquer, HH = Sand Matt Lacquer, MT = White Matt Lacquer, PD = Black Matt Lacquer, PH = Glossy Black Lacquer, GN = Walnut Veneer, PC = Oak Veneer

XX = Insert front and body colour
 GF = Glossy White Lacquer, GJ = Light Grey Matt Lacquer, GK = Anthracite Matt Lacquer, GM = Olive Matt Lacquer, HB = Peony Matt Lacquer, HG = Midnight Blue Matt Lacquer, HH = Sand Matt Lacquer, MT = White Matt Lacquer, PD = Black Matt Lacquer, PH = Glossy Black Lacquer, GN = Walnut Veneer, PC = Oak Veneer

Z = Insert colour code for cover panels
 1 = Glass White Matt, 2 = Glass Black Matt

FINION

€ excl. VAT

Registered design

Produced to order (Please note that it is not always possible to cancel or change orders!), The washbasins are to be ordered separately.

Express Delivery These products are always in stock.

	VANITY UNIT	VANITY UNIT	VANITY UNIT	VANITY UNIT
Article number	F70Z YY XX	G70Z YY XX	F71Z YY XX	G71Z YY XX
Dimensions (w x h x d)	1200 x 603 x 501 mm	1200 x 603 x 501 mm	1200 x 603 x 501 mm	1200 x 603 x 501 mm
Version	with shelf unit (illuminated), without drilled tap holes washbasin on the middle	with shelf unit (illuminated), with wall lighting, without drilled tap holes washbasin on the middle	with shelf unit (illuminated), without drilled tap holes washbasin on the middle	with shelf unit (illuminated), with wall lighting, without drilled tap holes washbasin on the middle
For combination with	Finion 4143 61	Finion 4143 61	Finion 4143 61	Finion 4143 61
Lighting	LED lighting Lighting 1x LED / 2,3 W	LED lighting Lighting 1x LED / 2,3 W, 2x LED / 4,2 W	LED lighting Lighting 1x LED / 2,3 W	LED lighting Lighting 1x LED / 2,3 W, 2x LED / 4,2 W
Equipped with	1x Accessories package Finion 3x pull-out compartment with non-slip mat	1x Accessories package Finion 3x pull-out compartment with non-slip mat	1x Accessories package Finion 3x pull-out compartment with non-slip mat	1x Accessories package Finion 3x pull-out compartment with non-slip mat
Note on standard	IP 44	IP 44	IP 44	IP 44
Installation	wall-mounted	wall-mounted	wall-mounted	wall-mounted
Scope of delivery	fastening set included	fastening set included	fastening set included	fastening set included
All colour combinations				

	VANITY UNIT	VANITY UNIT	VANITY UNIT	VANITY UNIT
Article number	F69Z YY XX	G69Z YY XX	F68Z YY XX	G68Z YY XX
Dimensions (w x h x d)	1200 x 603 x 501 mm	1200 x 603 x 501 mm	1200 x 603 x 501 mm	1200 x 603 x 501 mm
Version	with shelf unit (illuminated), without drilled tap holes washbasin on left	with shelf unit (illuminated), with wall lighting, without drilled tap holes washbasin on left	with shelf unit (illuminated), without drilled tap holes washbasin on right	with shelf unit (illuminated), with wall lighting, without drilled tap holes washbasin on right
For combination with	Finion 4143 61	Finion 4143 61	Finion 4143 61	Finion 4143 61
Lighting	LED lighting Lighting 1x LED / 2,3 W	LED lighting Lighting 1x LED / 2,3 W, 2x LED / 4,2 W	LED lighting Lighting 1x LED / 2,3 W	LED lighting Lighting 1x LED / 2,3 W, 2x LED / 4,2 W
Equipped with	1x Accessories package Finion 3x pull-out compartment with non-slip mat	1x Accessories package Finion 3x pull-out compartment with non-slip mat	1x Accessories package Finion 3x pull-out compartment with non-slip mat	1x Accessories package Finion 3x pull-out compartment with non-slip mat
Note on standard	IP 44	IP 44	IP 44	IP 44
Installation	wall-mounted	wall-mounted	wall-mounted	wall-mounted
Scope of delivery	fastening set included	fastening set included	fastening set included	fastening set included
All colour combinations				

To see how the article number is structured, refer to page 102

YY = Insert shelf colour
 GF = Glossy White Lacquer, GJ = Light Grey Matt Lacquer, GK = Anthracite Matt Lacquer, GM = Olive Matt Lacquer, HB = Peony Matt Lacquer, HF = Gold Matt Lacquer, HG = Midnight Blue Matt Lacquer, HH = Sand Matt Lacquer, MT = White Matt Lacquer, PD = Black Matt Lacquer, PH = Glossy Black Lacquer, GN = Walnut Veneer, PC = Oak Veneer

XX = Insert front and body colour
 GF = Glossy White Lacquer, GJ = Light Grey Matt Lacquer, GK = Anthracite Matt Lacquer, GM = Olive Matt Lacquer, HB = Peony Matt Lacquer, HG = Midnight Blue Matt Lacquer, HH = Sand Matt Lacquer, MT = White Matt Lacquer, PD = Black Matt Lacquer, PH = Glossy Black Lacquer, GN = Walnut Veneer, PC = Oak Veneer

Z = Insert colour code for cover panels
 1 = Glass White Matt, 2 = Glass Black Matt





FINION





€ excl. VAT

Registered design

Produced to order (Please note that it is not always possible to cancel or change orders!), The washbasins are to be ordered separately.

Express Delivery These products are always in stock.

	VANITY UNIT	VANITY UNIT	VANITY UNIT	VANITY UNIT
				
Article number	F64Z 00 XX	G64Z 00 XX	F65Z YY XX	G65Z YY XX
Dimensions (w x h x d)	1000 x 603 x 501 mm	1000 x 603 x 501 mm	1000 x 603 x 501 mm	1000 x 603 x 501 mm
Version	without drilled tap holes washbasin on the middle	with wall lighting, without drilled tap holes washbasin on the middle	with shelf unit (illuminated), without drilled tap holes washbasin on the middle	with shelf unit (illuminated), with wall lighting, without drilled tap holes washbasin on the middle
For combination with	Finion 4143 61	Finion 4143 61	Finion 4143 61	Finion 4143 61
Lighting	-	LED lighting Lighting 2x LED / 4,2 W	LED lighting Lighting 1x LED / 2,3 W	LED lighting Lighting 1x LED / 2,3 W, 2x LED / 4,2 W
Equipped with	1x Accessories package Finion 2x pull-out compartment with non-slip mat	1x Accessories package Finion 2x pull-out compartment with non-slip mat	1x Accessories package Finion 2x pull-out compartment with non-slip mat	1x Accessories package Finion 2x pull-out compartment with non-slip mat
Note on standard	-	IP 44	IP 44	IP 44
Installation	wall-mounted	wall-mounted	wall-mounted	wall-mounted
Scope of delivery	fastening set included	fastening set included	fastening set included	fastening set included
All colour combinations				

	VANITY UNIT	VANITY UNIT	VANITY UNIT	VANITY UNIT
				
Article number	F66Z YY XX	G66Z YY XX	F63Z 00 XX	G63Z 00 XX
Dimensions (w x h x d)	1000 x 603 x 501 mm	1000 x 603 x 501 mm	800 x 603 x 501 mm	800 x 603 x 501 mm
Version	with shelf unit (illuminated), without drilled tap holes washbasin on the middle	with shelf unit (illuminated), with wall lighting, without drilled tap holes washbasin on the middle	without drilled tap holes washbasin on the middle	with wall lighting, without drilled tap holes washbasin on the middle
For combination with	Finion 4143 61	Finion 4143 61	Finion 4143 61	Finion 4143 61
Lighting	LED lighting Lighting 1x LED / 2,3 W	LED lighting Lighting 1x LED / 2,3 W, 2x LED / 4,2 W	-	LED lighting Lighting 2x LED / 4,2 W
Equipped with	1x Accessories package Finion 2x pull-out compartment with non-slip mat	1x Accessories package Finion 2x pull-out compartment with non-slip mat	1x Accessories package Finion 2x pull-out compartment with non-slip mat	1x Accessories package Finion 2x pull-out compartment with non-slip mat
Note on standard	IP 44	IP 44	-	IP 44
Installation	wall-mounted	wall-mounted	wall-mounted	wall-mounted
Scope of delivery	fastening set included	fastening set included	fastening set included	fastening set included
All colour combinations				

To see how the article number is structured, refer to page 102

YY = Insert shelf colour
 GF = Glossy White Lacquer, GJ = Light Grey Matt Lacquer, GK = Anthracite Matt Lacquer, GM = Olive Matt Lacquer, HB = Peony Matt Lacquer, HF = Gold Matt Lacquer, HG = Midnight Blue Matt Lacquer, HH = Sand Matt Lacquer, MT = White Matt Lacquer, PD = Black Matt Lacquer, PH = Glossy Black Lacquer, GN = Walnut Veneer, PC = Oak Veneer

XX = Insert front and body colour
 GF = Glossy White Lacquer, GJ = Light Grey Matt Lacquer, GK = Anthracite Matt Lacquer, GM = Olive Matt Lacquer, HB = Peony Matt Lacquer, HG = Midnight Blue Matt Lacquer, HH = Sand Matt Lacquer, MT = White Matt Lacquer, PD = Black Matt Lacquer, PH = Glossy Black Lacquer, GN = Walnut Veneer, PC = Oak Veneer

Z = Insert colour code for cover panels
 1 = Glass White Matt, 2 = Glass Black Matt

FINION





FINION





€ excl. VAT

Registered design

Produced to order (Please note that it is not always possible to cancel or change orders!), The washbasins are to be ordered separately.

Express Delivery These products are always in stock.

	VANITY UNIT	VANITY UNIT	VANITY UNIT	VANITY UNIT
				
Article number	F43Z 00 XX	G43Z 00 XX	F44Z 00 XX	G44Z 00 XX
Dimensions (w x h x d)	1600 x 603 x 501 mm	1600 x 603 x 501 mm	1600 x 603 x 501 mm	1600 x 603 x 501 mm
Version	for 2 washbasins	with wall lighting for 2 washbasins	washbasin on the middle	with wall lighting washbasin on the middle
For combination with	Finion 4142 61/64 Memento 2.0 4A07 60/61	Finion 4142 61/64 Memento 2.0 4A07 60/61	Finion 4142 61/64 Memento 2.0 4A07 60/61	Finion 4142 61/64 Memento 2.0 4A07 60/61
Lighting	-	LED lighting Lighting 2x LED / 4,2 W	-	LED lighting Lighting 2x LED / 4,2 W
Equipped with	2x Accessories package Finion 4x pull-out compartment with non-slip mat	2x Accessories package Finion 4x pull-out compartment with non-slip mat	2x Accessories package Finion 4x pull-out compartment with non-slip mat	2x Accessories package Finion 4x pull-out compartment with non-slip mat
Note on standard	-	IP 44	-	IP 44
Installation	wall-mounted	wall-mounted	wall-mounted	wall-mounted
Scope of delivery	fastening set included	fastening set included	fastening set included	fastening set included
All colour combinations				

	VANITY UNIT	VANITY UNIT	VANITY UNIT	VANITY UNIT
				
Article number	F45Z YY XX	G45Z YY XX	F38Z 00 XX	G38Z 00 XX
Dimensions (w x h x d)	1600 x 603 x 501 mm	1600 x 603 x 501 mm	1200 x 603 x 501 mm	1200 x 603 x 501 mm
Version	with shelf unit (illuminated) washbasin on the middle	with shelf unit (illuminated), with wall lighting washbasin on the middle	washbasin on the middle	with wall lighting washbasin on the middle
For combination with	Finion 4142 61/64 Memento 2.0 4A07 60/61	Finion 4142 61/64 Memento 2.0 4A07 60/61	Finion 4142 61/64 Memento 2.0 4A07 60/61	Finion 4142 61/64 Memento 2.0 4A07 60/61
Lighting	LED lighting Lighting 2x LED / 2,3 W	LED lighting Lighting 2x LED / 2,3 W, 2x LED / 4,2 W	-	LED lighting Lighting 2x LED / 4,2 W
Equipped with	1x Accessories package Finion 4x pull-out compartment with non-slip mat	1x Accessories package Finion 4x pull-out compartment with non-slip mat	2x Accessories package Finion 4x pull-out compartment with non-slip mat	2x Accessories package Finion 4x pull-out compartment with non-slip mat
Note on standard	IP 44	IP 44	-	IP 44
Installation	wall-mounted	wall-mounted	wall-mounted	wall-mounted
Scope of delivery	fastening set included	fastening set included	fastening set included	fastening set included
All colour combinations				

To see how the article number is structured, refer to page 102

YY = Insert shelf colour
GF = Glossy White Lacquer, GJ = Light Grey Matt Lacquer, GK = Anthracite Matt Lacquer, GM = Olive Matt Lacquer, HB = Peony Matt Lacquer, HF = Gold Matt Lacquer, HG = Midnight Blue Matt Lacquer, HH = Sand Matt Lacquer, MT = White Matt Lacquer, PD = Black Matt Lacquer, PH = Glossy Black Lacquer, GN = Walnut Veneer, PC = Oak Veneer

XX = Insert front and body colour
GF = Glossy White Lacquer, GJ = Light Grey Matt Lacquer, GK = Anthracite Matt Lacquer, GM = Olive Matt Lacquer, HB = Peony Matt Lacquer, HG = Midnight Blue Matt Lacquer, HH = Sand Matt Lacquer, MT = White Matt Lacquer, PD = Black Matt Lacquer, PH = Glossy Black Lacquer, GN = Walnut Veneer, PC = Oak Veneer

Z = Insert colour code for cover panels
1 = Glass White Matt, 2 = Glass Black Matt

FINION

€ excl. VAT

Registered design

Produced to order (Please note that it is not always possible to cancel or change orders!), The washbasins are to be ordered separately.

Express Delivery These products are always in stock.

	VANITY UNIT	VANITY UNIT	VANITY UNIT	VANITY UNIT
Article number	F41Z YY XX	G41Z YY XX	F42Z YY XX	G42Z YY XX
Dimensions (w x h x d)	1200 x 603 x 501 mm	1200 x 603 x 501 mm	1200 x 603 x 501 mm	1200 x 603 x 501 mm
Version	with shelf unit (illuminated) washbasin on the middle	with shelf unit (illuminated), with wall lighting washbasin on the middle	with shelf unit (illuminated) washbasin on the middle	with shelf unit (illuminated), with wall lighting washbasin on the middle
For combination with	Finion 4142 61/64 Memento 2.0 4A07 60/61	Finion 4142 61/64 Memento 2.0 4A07 60/61	Finion 4142 61/64 Memento 2.0 4A07 60/61	Finion 4142 61/64 Memento 2.0 4A07 60/61
Lighting	LED lighting Lighting 1x LED / 2,3 W	LED lighting Lighting 1x LED / 2,3 W, 2x LED / 4,2 W	LED lighting Lighting 1x LED / 2,3 W	LED lighting Lighting 1x LED / 2,3 W, 2x LED / 4,2 W
Equipped with	1x Accessories package Finion 3x pull-out compartment with non-slip mat	1x Accessories package Finion 3x pull-out compartment with non-slip mat	1x Accessories package Finion 3x pull-out compartment with non-slip mat	1x Accessories package Finion 3x pull-out compartment with non-slip mat
Note on standard	IP 44	IP 44	IP 44	IP 44
Installation	wall-mounted	wall-mounted	wall-mounted	wall-mounted
Scope of delivery	fastening set included	fastening set included	fastening set included	fastening set included
All colour combinations				

	VANITY UNIT	VANITY UNIT	VANITY UNIT	VANITY UNIT
Article number	F40Z YY XX	G40Z YY XX	F39Z YY XX	G39Z YY XX
Dimensions (w x h x d)	1200 x 603 x 501 mm	1200 x 603 x 501 mm	1200 x 603 x 501 mm	1200 x 603 x 501 mm
Version	with shelf unit (illuminated) washbasin on left	with shelf unit (illuminated), with wall lighting washbasin on left	with shelf unit (illuminated) washbasin on right	with shelf unit (illuminated), with wall lighting washbasin on right
For combination with	Finion 4142 61/64 Memento 2.0 4A07 60/61	Finion 4142 61/64 Memento 2.0 4A07 60/61	Finion 4142 61/64 Memento 2.0 4A07 60/61	Finion 4142 61/64 Memento 2.0 4A07 60/61
Lighting	LED lighting Lighting 1x LED / 2,3 W	LED lighting Lighting 1x LED / 2,3 W, 2x LED / 4,2 W	LED lighting Lighting 1x LED / 2,3 W	LED lighting Lighting 1x LED / 2,3 W, 2x LED / 4,2 W
Equipped with	1x Accessories package Finion 3x pull-out compartment with non-slip mat	1x Accessories package Finion 3x pull-out compartment with non-slip mat	1x Accessories package Finion 3x pull-out compartment with non-slip mat	1x Accessories package Finion 3x pull-out compartment with non-slip mat
Note on standard	IP 44	IP 44	IP 44	IP 44
Installation	wall-mounted	wall-mounted	wall-mounted	wall-mounted
Scope of delivery	fastening set included	fastening set included	fastening set included	fastening set included
All colour combinations				

To see how the article number is structured, refer to page 102

YY = Insert shelf colour
 GF = Glossy White Lacquer, GJ = Light Grey Matt Lacquer, GK = Anthracite Matt Lacquer, GM = Olive Matt Lacquer, HB = Peony Matt Lacquer, HF = Gold Matt Lacquer, HG = Midnight Blue Matt Lacquer, HH = Sand Matt Lacquer, MT = White Matt Lacquer, PD = Black Matt Lacquer, PH = Glossy Black Lacquer, GN = Walnut Veneer, PC = Oak Veneer

XX = Insert front and body colour
 GF = Glossy White Lacquer, GJ = Light Grey Matt Lacquer, GK = Anthracite Matt Lacquer, GM = Olive Matt Lacquer, HB = Peony Matt Lacquer, HG = Midnight Blue Matt Lacquer, HH = Sand Matt Lacquer, MT = White Matt Lacquer, PD = Black Matt Lacquer, PH = Glossy Black Lacquer, GN = Walnut Veneer, PC = Oak Veneer

Z = Insert colour code for cover panels
 1 = Glass White Matt, 2 = Glass Black Matt

FINION

FINION

€ excl. VAT

Registered design

Produced to order (Please note that it is not always possible to cancel or change orders!), The washbasins are to be ordered separately.

Express Delivery

These products are always in stock.

	VANITY UNIT	VANITY UNIT	VANITY UNIT	VANITY UNIT
Article number	F35Z 00 XX	G35Z 00 XX	F36Z YY XX	G36Z YY XX
Dimensions (w x h x d)	1000 x 603 x 501 mm	1000 x 603 x 501 mm	1000 x 603 x 501 mm	1000 x 603 x 501 mm
Version	washbasin on the middle	with wall lighting washbasin on the middle	with shelf unit (illuminated) washbasin on the middle	with shelf unit (illuminated), with wall lighting washbasin on the middle
For combination with	Finion 4142 61/64 Memento 2.0 4A07 60/61	Finion 4142 61/64 Memento 2.0 4A07 60/61	Finion 4142 61/64 Memento 2.0 4A07 60/61	Finion 4142 61/64 Memento 2.0 4A07 60/61
Lighting	-	LED lighting Lighting 2x LED / 4,2 W	LED lighting Lighting 1x LED / 2,3 W	LED lighting Lighting 1x LED / 2,3 W, 2x LED / 4,2 W
Equipped with	1x Accessories package Finion 2x pull-out compartment with non-slip mat	1x Accessories package Finion 2x pull-out compartment with non-slip mat	1x Accessories package Finion 2x pull-out compartment with non-slip mat	1x Accessories package Finion 2x pull-out compartment with non-slip mat
Note on standard	-	IP 44	IP 44	IP 44
Installation	wall-mounted	wall-mounted	wall-mounted	wall-mounted
Scope of delivery	fastening set included	fastening set included	fastening set included	fastening set included
All colour combinations				

	VANITY UNIT	VANITY UNIT	VANITY UNIT	VANITY UNIT
Article number	F37Z YY XX	G37Z YY XX	F34Z 00 XX	G34Z 00 XX
Dimensions (w x h x d)	1000 x 603 x 501 mm	1000 x 603 x 501 mm	800 x 603 x 501 mm	800 x 603 x 501 mm
Version	with shelf unit (illuminated) washbasin on the middle	with shelf unit (illuminated), with wall lighting washbasin on the middle	washbasin on the middle	with wall lighting washbasin on the middle
For combination with	Finion 4142 61/64 Memento 2.0 4A07 60/61	Finion 4142 61/64 Memento 2.0 4A07 60/61	Finion 4142 61/64 Memento 2.0 4A07 60/61	Finion 4142 61/64 Memento 2.0 4A07 60/61
Lighting	LED lighting Lighting 1x LED / 2,3 W	LED lighting Lighting 1x LED / 2,3 W, 2x LED / 4,2 W	-	LED lighting Lighting 2x LED / 4,2 W
Equipped with	1x Accessories package Finion 2x pull-out compartment with non-slip mat	1x Accessories package Finion 2x pull-out compartment with non-slip mat	1x Accessories package Finion 2x pull-out compartment with non-slip mat	1x Accessories package Finion 2x pull-out compartment with non-slip mat
Note on standard	IP 44	IP 44	-	IP 44
Installation	wall-mounted	wall-mounted	wall-mounted	wall-mounted
Scope of delivery	fastening set included	fastening set included	fastening set included	fastening set included
All colour combinations				

To see how the article number is structured, refer to page 102

YY = Insert shelf colour
 GF = Glossy White Lacquer, GJ = Light Grey Matt Lacquer, GK = Anthracite Matt Lacquer, GM = Olive Matt Lacquer, HB = Peony Matt Lacquer, HF = Gold Matt Lacquer, HG = Midnight Blue Matt Lacquer, HH = Sand Matt Lacquer, MT = White Matt Lacquer, PD = Black Matt Lacquer, PH = Glossy Black Lacquer, GN = Walnut Veneer, PC = Oak Veneer

XX = Insert front and body colour
 GF = Glossy White Lacquer, GJ = Light Grey Matt Lacquer, GK = Anthracite Matt Lacquer, GM = Olive Matt Lacquer, HB = Peony Matt Lacquer, HG = Midnight Blue Matt Lacquer, HH = Sand Matt Lacquer, MT = White Matt Lacquer, PD = Black Matt Lacquer, PH = Glossy Black Lacquer, GN = Walnut Veneer, PC = Oak Veneer

Z = Insert colour code for cover panels
 1 = Glass White Matt, 2 = Glass Black Matt





FINION





€ excl. VAT

Registered design

Produced to order (Please note that it is not always possible to cancel or change orders!), The washbasins are to be ordered separately.

Express Delivery These products are always in stock.

	VANITY UNIT	VANITY UNIT	VANITY UNIT	VANITY UNIT
				
Article number	F84Z 00 XX	G84Z 00 XX	F85Z 00 XX	G85Z 00 XX
Dimensions (w x h x d)	1600 x 603 x 501 mm	1600 x 603 x 501 mm	1600 x 603 x 501 mm	1600 x 603 x 501 mm
Version	with drilled tap holes for 2 washbasins	with wall lighting, with drilled tap holes for 2 washbasins	with drilled tap holes washbasin on the middle	with wall lighting, with drilled tap holes washbasin on the middle
For combination with	Artis 4172 58 Collaro 4A21 38, 4A19 56, 4A20 56	Artis 4172 58 Collaro 4A21 38, 4A19 56, 4A20 56	Artis 4172 58 Collaro 4A21 38, 4A19 56, 4A20 56	Artis 4172 58 Collaro 4A21 38, 4A19 56, 4A20 56
Lighting	-	LED lighting Lighting 2x LED / 4,2 W	-	LED lighting Lighting 2x LED / 4,2 W
Equipped with	2x Accessories package Finion 4x pull-out compartment with non-slip mat	2x Accessories package Finion 4x pull-out compartment with non-slip mat	2x Accessories package Finion 4x pull-out compartment with non-slip mat	2x Accessories package Finion 4x pull-out compartment with non-slip mat
Note on standard	-	IP 44	-	IP 44
Installation	wall-mounted	wall-mounted	wall-mounted	wall-mounted
Scope of delivery	fastening set included	fastening set included	fastening set included	fastening set included
All colour combinations				

	VANITY UNIT	VANITY UNIT	VANITY UNIT	VANITY UNIT
				
Article number	F86Z YY XX	G86Z YY XX	F79Z 00 XX	G79Z 00 XX
Dimensions (w x h x d)	1600 x 603 x 501 mm	1600 x 603 x 501 mm	1200 x 603 x 501 mm	1200 x 603 x 501 mm
Version	with shelf unit (illuminated), with drilled tap holes washbasin on the middle	with shelf unit (illuminated), with wall lighting, with drilled tap holes washbasin on the middle	with drilled tap holes washbasin on the middle	with wall lighting, with drilled tap holes washbasin on the middle
For combination with	Artis 4172 58 Collaro 4A21 38, 4A19 56, 4A20 56	Artis 4172 58 Collaro 4A21 38, 4A19 56, 4A20 56	Artis 4172 58 Collaro 4A21 38, 4A19 56, 4A20 56	Artis 4172 58 Collaro 4A21 38, 4A19 56, 4A20 56
Lighting	LED lighting Lighting 2x LED / 2,3 W	LED lighting Lighting 2x LED / 2,3 W, 2x LED / 4,2 W	-	LED lighting Lighting 2x LED / 4,2 W
Equipped with	1x Accessories package Finion 4x pull-out compartment with non-slip mat	1x Accessories package Finion 4x pull-out compartment with non-slip mat	2x Accessories package Finion 4x pull-out compartment with non-slip mat	2x Accessories package Finion 4x pull-out compartment with non-slip mat
Note on standard	IP 44	IP 44	-	IP 44
Installation	wall-mounted	wall-mounted	wall-mounted	wall-mounted
Scope of delivery	fastening set included	fastening set included	fastening set included	fastening set included
All colour combinations				

To see how the article number is structured, refer to page 102

YY = Insert shelf colour
 GF = Glossy White Lacquer, GJ = Light Grey Matt Lacquer, GK = Anthracite Matt Lacquer, GM = Olive Matt Lacquer, HB = Peony Matt Lacquer, HF = Gold Matt Lacquer, HG = Midnight Blue Matt Lacquer, HH = Sand Matt Lacquer, MT = White Matt Lacquer, PD = Black Matt Lacquer, PH = Glossy Black Lacquer, GN = Walnut Veneer, PC = Oak Veneer

XX = Insert front and body colour
 GF = Glossy White Lacquer, GJ = Light Grey Matt Lacquer, GK = Anthracite Matt Lacquer, GM = Olive Matt Lacquer, HB = Peony Matt Lacquer, HG = Midnight Blue Matt Lacquer, HH = Sand Matt Lacquer, MT = White Matt Lacquer, PD = Black Matt Lacquer, PH = Glossy Black Lacquer, GN = Walnut Veneer, PC = Oak Veneer

Z = Insert colour code for cover panels
 1 = Glass White Matt, 2 = Glass Black Matt

FINION

FINION





€ excl. VAT





Registered design

Produced to order (Please note that it is not always possible to cancel or change orders!), The washbasins are to be ordered separately.

Express Delivery

These products are always in stock.

	VANITY UNIT	VANITY UNIT	VANITY UNIT	VANITY UNIT
				
Article number	F80Z YY XX	G80Z YY XX	F81Z YY XX	G81Z YY XX
Dimensions (w x h x d)	1200 x 603 x 501 mm	1200 x 603 x 501 mm	1200 x 603 x 501 mm	1200 x 603 x 501 mm
Version	with shelf unit (illuminated), with drilled tap holes washbasin on right	with shelf unit (illuminated), with wall lighting, with drilled tap holes washbasin on right	with shelf unit (illuminated), with drilled tap holes washbasin on left	with shelf unit (illuminated), with wall lighting, with drilled tap holes washbasin on left
For combination with	Artis 4172 58 Collaro 4A21 38, 4A19 56, 4A20 56	Artis 4172 58 Collaro 4A21 38, 4A19 56, 4A20 56	Artis 4172 58 Collaro 4A21 38, 4A19 56, 4A20 56	Artis 4172 58 Collaro 4A21 38, 4A19 56, 4A20 56
Lighting	LED lighting Lighting 1x LED / 2,3 W	LED lighting Lighting 1x LED / 2,3 W, 2x LED / 4,2 W	LED lighting Lighting 1x LED / 2,3 W	LED lighting Lighting 1x LED / 2,3 W, 2x LED / 4,2 W
Equipped with	1x Accessories package Finion 3x pull-out compartment with non-slip mat	1x Accessories package Finion 3x pull-out compartment with non-slip mat	1x Accessories package Finion 3x pull-out compartment with non-slip mat	1x Accessories package Finion 3x pull-out compartment with non-slip mat
Note on standard	IP 44	IP 44	IP 44	IP 44
Installation	wall-mounted	wall-mounted	wall-mounted	wall-mounted
Scope of delivery	fastening set included	fastening set included	fastening set included	fastening set included
All colour combinations				

	VANITY UNIT	VANITY UNIT	VANITY UNIT	VANITY UNIT
				
Article number	F82Z YY XX	G82Z YY XX	F83Z YY XX	G83Z YY XX
Dimensions (w x h x d)	1200 x 603 x 501 mm	1200 x 603 x 501 mm	1200 x 603 x 501 mm	1200 x 603 x 501 mm
Version	with shelf unit (illuminated), with drilled tap holes washbasin on the middle	with shelf unit (illuminated), with wall lighting, with drilled tap holes washbasin on the middle	with shelf unit (illuminated), with drilled tap holes washbasin on the middle	with shelf unit (illuminated), with wall lighting, with drilled tap holes washbasin on the middle
For combination with	Artis 4172 58 Collaro 4A21 38, 4A19 56, 4A20 56	Artis 4172 58 Collaro 4A21 38, 4A19 56, 4A20 56	Artis 4172 58 Collaro 4A21 38, 4A19 56, 4A20 56	Artis 4172 58 Collaro 4A21 38, 4A19 56, 4A20 56
Lighting	LED lighting Lighting 1x LED / 2,3 W	LED lighting Lighting 1x LED / 2,3 W, 2x LED / 4,2 W	LED lighting Lighting 1x LED / 2,3 W	LED lighting Lighting 1x LED / 2,3 W, 2x LED / 4,2 W
Equipped with	1x Accessories package Finion 3x pull-out compartment with non-slip mat	1x Accessories package Finion 3x pull-out compartment with non-slip mat	1x Accessories package Finion 3x pull-out compartment with non-slip mat	1x Accessories package Finion 3x pull-out compartment with non-slip mat
Note on standard	IP 44	IP 44	IP 44	IP 44
Installation	wall-mounted	wall-mounted	wall-mounted	wall-mounted
Scope of delivery	fastening set included	fastening set included	fastening set included	fastening set included
All colour combinations				

To see how the article number is structured, refer to page 102

YY = Insert shelf colour
 GF = Glossy White Lacquer, GJ = Light Grey Matt Lacquer, GK = Anthracite Matt Lacquer, GM = Olive Matt Lacquer, HB = Peony Matt Lacquer, HF = Gold Matt Lacquer, HG = Midnight Blue Matt Lacquer, HH = Sand Matt Lacquer, MT = White Matt Lacquer, PD = Black Matt Lacquer, PH = Glossy Black Lacquer, GN = Walnut Veneer, PC = Oak Veneer

XX = Insert front and body colour
 GF = Glossy White Lacquer, GJ = Light Grey Matt Lacquer, GK = Anthracite Matt Lacquer, GM = Olive Matt Lacquer, HB = Peony Matt Lacquer, HG = Midnight Blue Matt Lacquer, HH = Sand Matt Lacquer, MT = White Matt Lacquer, PD = Black Matt Lacquer, PH = Glossy Black Lacquer, GN = Walnut Veneer, PC = Oak Veneer

Z = Insert colour code for cover panels
 1 = Glass White Matt, 2 = Glass Black Matt





FINION





€ excl. VAT

Registered design

Produced to order (Please note that it is not always possible to cancel or change orders!), The washbasins are to be ordered separately.

Express Delivery These products are always in stock.

	VANITY UNIT	VANITY UNIT	VANITY UNIT	VANITY UNIT
				
Article number	F76Z 00 XX	G76Z 00 XX	F77Z YY XX	G77Z YY XX
Dimensions (w x h x d)	1000 x 603 x 501 mm	1000 x 603 x 501 mm	1000 x 603 x 501 mm	1000 x 603 x 501 mm
Version	with drilled tap holes washbasin on the middle	with wall lighting, with drilled tap holes washbasin on the middle	with shelf unit (illuminated), with drilled tap holes washbasin on the middle	with shelf unit (illuminated), with wall lighting, with drilled tap holes washbasin on the middle
For combination with	Artis 4172 58 Collaro 4A21 38, 4A19 56, 4A20 56	Artis 4172 58 Collaro 4A21 38, 4A19 56, 4A20 56	Artis 4172 58 Collaro 4A21 38, 4A19 56, 4A20 56	Artis 4172 58 Collaro 4A21 38, 4A19 56, 4A20 56
Lighting	-	LED lighting Lighting 2x LED / 4,2 W	LED lighting Lighting 1x LED / 2,3 W	LED lighting Lighting 1x LED / 2,3 W, 2x LED / 4,2 W
Equipped with	1x Accessories package Finion 2x pull-out compartment with non-slip mat	1x Accessories package Finion 2x pull-out compartment with non-slip mat	1x Accessories package Finion 2x pull-out compartment with non-slip mat	1x Accessories package Finion 2x pull-out compartment with non-slip mat
Note on standard	-	IP 44	IP 44	IP 44
Installation	wall-mounted	wall-mounted	wall-mounted	wall-mounted
Scope of delivery	fastening set included	fastening set included	fastening set included	fastening set included
All colour combinations				

	VANITY UNIT	VANITY UNIT	VANITY UNIT	VANITY UNIT
				
Article number	F78Z YY XX	G78Z YY XX	F75Z 00 XX	G75Z 00 XX
Dimensions (w x h x d)	1000 x 603 x 501 mm	1000 x 603 x 501 mm	800 x 603 x 501 mm	800 x 603 x 501 mm
Version	with shelf unit (illuminated), with drilled tap holes washbasin on the middle	with shelf unit (illuminated), with wall lighting, with drilled tap holes washbasin on the middle	with drilled tap holes washbasin on the middle	with wall lighting, with drilled tap holes washbasin on the middle
For combination with	Artis 4172 58 Collaro 4A21 38, 4A19 56, 4A20 56	Artis 4172 58 Collaro 4A21 38, 4A19 56, 4A20 56	Artis 4172 58 Collaro 4A21 38, 4A19 56, 4A20 56	Artis 4172 58 Collaro 4A21 38, 4A19 56, 4A20 56
Lighting	LED lighting Lighting 1x LED / 2,3 W	LED lighting Lighting 1x LED / 2,3 W, 2x LED / 4,2 W	-	LED lighting Lighting 2x LED / 4,2 W
Equipped with	1x Accessories package Finion 2x pull-out compartment with non-slip mat	1x Accessories package Finion 2x pull-out compartment with non-slip mat	1x Accessories package Finion 2x pull-out compartment with non-slip mat	1x Accessories package Finion 2x pull-out compartment with non-slip mat
Note on standard	IP 44	IP 44	-	IP 44
Installation	wall-mounted	wall-mounted	wall-mounted	wall-mounted
Scope of delivery	fastening set included	fastening set included	fastening set included	fastening set included
All colour combinations				

To see how the article number is structured, refer to page 102

YY = Insert shelf colour
 GF = Glossy White Lacquer, GJ = Light Grey Matt Lacquer, GK = Anthracite Matt Lacquer, GM = Olive Matt Lacquer, HB = Peony Matt Lacquer, HF = Gold Matt Lacquer, HG = Midnight Blue Matt Lacquer, HH = Sand Matt Lacquer, MT = White Matt Lacquer, PD = Black Matt Lacquer, PH = Glossy Black Lacquer, GN = Walnut Veneer, PC = Oak Veneer

XX = Insert front and body colour
 GF = Glossy White Lacquer, GJ = Light Grey Matt Lacquer, GK = Anthracite Matt Lacquer, GM = Olive Matt Lacquer, HB = Peony Matt Lacquer, HG = Midnight Blue Matt Lacquer, HH = Sand Matt Lacquer, MT = White Matt Lacquer, PD = Black Matt Lacquer, PH = Glossy Black Lacquer, GN = Walnut Veneer, PC = Oak Veneer

Z = Insert colour code for cover panels
 1 = Glass White Matt, 2 = Glass Black Matt

FINION





FINION





€ excl. VAT

Registered design

Produced to order (Please note that it is not always possible to cancel or change orders!), The washbasins are to be ordered separately.

Express Delivery These products are always in stock.

	VANITY UNIT	VANITY UNIT	VANITY UNIT	VANITY UNIT
				
Article number	F96Z 00 XX	G96Z 00 XX	F97Z 00 XX	G97Z 00 XX
Dimensions (w x h x d)	1600 x 603 x 501 mm	1600 x 603 x 501 mm	1600 x 603 x 501 mm	1600 x 603 x 501 mm
Version	with drilled tap holes for 2 washbasins	with wall lighting, with drilled tap holes for 2 washbasins	with drilled tap holes washbasin on the middle	with wall lighting, with drilled tap holes washbasin on the middle
For combination with	Artis 4198 61, 4179 43 Collaro 4A18 40	Artis 4198 61, 4179 43 Collaro 4A18 40	Artis 4198 61, 4179 43 Collaro 4A18 40	Artis 4198 61, 4179 43 Collaro 4A18 40
Lighting	-	LED lighting Lighting 2x LED / 4,2 W	-	LED lighting Lighting 2x LED / 4,2 W
Equipped with	2x Accessories package Finion 4x pull-out compartment with non-slip mat	2x Accessories package Finion 4x pull-out compartment with non-slip mat	2x Accessories package Finion 4x pull-out compartment with non-slip mat	2x Accessories package Finion 4x pull-out compartment with non-slip mat
Note on standard	-	IP 44	-	IP 44
Installation	wall-mounted	wall-mounted	wall-mounted	wall-mounted
Scope of delivery	fastening set included	fastening set included	fastening set included	fastening set included
All colour combinations				

	VANITY UNIT	VANITY UNIT	VANITY UNIT	VANITY UNIT
				
Article number	F98Z YY XX	G98Z YY XX	F91Z 00 XX	G91Z 00 XX
Dimensions (w x h x d)	1600 x 603 x 501 mm	1600 x 603 x 501 mm	1200 x 603 x 501 mm	1200 x 603 x 501 mm
Version	with shelf unit (illuminated), with drilled tap holes washbasin on the middle	with shelf unit (illuminated), with wall lighting, with drilled tap holes washbasin on the middle	with drilled tap holes washbasin on the middle	with wall lighting, with drilled tap holes washbasin on the middle
For combination with	Artis 4198 61, 4179 43 Collaro 4A18 40	Artis 4198 61, 4179 43 Collaro 4A18 40	Artis 4198 61, 4179 43 Collaro 4A18 40	Artis 4198 61, 4179 43 Collaro 4A18 40
Lighting	LED lighting Lighting 2x LED / 2,3 W	LED lighting Lighting 2x LED / 2,3 W, 2x LED / 4,2 W	-	LED lighting Lighting 2x LED / 4,2 W
Equipped with	1x Accessories package Finion 4x pull-out compartment with non-slip mat	1x Accessories package Finion 4x pull-out compartment with non-slip mat	2x Accessories package Finion 4x pull-out compartment with non-slip mat	2x Accessories package Finion 4x pull-out compartment with non-slip mat
Note on standard	IP 44	IP 44	-	IP 44
Installation	wall-mounted	wall-mounted	wall-mounted	wall-mounted
Scope of delivery	fastening set included	fastening set included	fastening set included	fastening set included
All colour combinations				

To see how the article number is structured, refer to page 102

YY = Insert shelf colour
 GF = Glossy White Lacquer, GJ = Light Grey Matt Lacquer, GK = Anthracite Matt Lacquer, GM = Olive Matt Lacquer, HB = Peony Matt Lacquer, HF = Gold Matt Lacquer, HG = Midnight Blue Matt Lacquer, HH = Sand Matt Lacquer, MT = White Matt Lacquer, PD = Black Matt Lacquer, PH = Glossy Black Lacquer, GN = Walnut Veneer, PC = Oak Veneer

XX = Insert front and body colour
 GF = Glossy White Lacquer, GJ = Light Grey Matt Lacquer, GK = Anthracite Matt Lacquer, GM = Olive Matt Lacquer, HB = Peony Matt Lacquer, HG = Midnight Blue Matt Lacquer, HH = Sand Matt Lacquer, MT = White Matt Lacquer, PD = Black Matt Lacquer, PH = Glossy Black Lacquer, GN = Walnut Veneer, PC = Oak Veneer

Z = Insert colour code for cover panels
 1 = Glass White Matt, 2 = Glass Black Matt

FINION

€ excl. VAT

Registered design

Produced to order (Please note that it is not always possible to cancel or change orders!), The washbasins are to be ordered separately.

Express Delivery

These products are always in stock.

	VANITY UNIT	VANITY UNIT	VANITY UNIT	VANITY UNIT
Article number	F92Z YY XX	G92Z YY XX	F93Z YY XX	G93Z YY XX
Dimensions (w x h x d)	1200 x 603 x 501 mm	1200 x 603 x 501 mm	1200 x 603 x 501 mm	1200 x 603 x 501 mm
Version	with shelf unit (illuminated), with drilled tap holes washbasin on right	with shelf unit (illuminated), with wall lighting, with drilled tap holes washbasin on right	with shelf unit (illuminated), with drilled tap holes washbasin on left	with shelf unit (illuminated), with wall lighting, with drilled tap holes washbasin on left
For combination with	Artis 4198 61, 4179 43 Collaro 4A18 40	Artis 4198 61, 4179 43 Collaro 4A18 40	Artis 4198 61, 4179 43 Collaro 4A18 40	Artis 4198 61, 4179 43 Collaro 4A18 40
Lighting	LED lighting Lighting 1x LED / 2,3 W	LED lighting Lighting 1x LED / 2,3 W, 2x LED / 4,2 W	LED lighting Lighting 1x LED / 2,3 W	LED lighting Lighting 1x LED / 2,3 W, 2x LED / 4,2 W
Equipped with	1x Accessories package Finion 3x pull-out compartment with non-slip mat	1x Accessories package Finion 3x pull-out compartment with non-slip mat	1x Accessories package Finion 3x pull-out compartment with non-slip mat	1x Accessories package Finion 3x pull-out compartment with non-slip mat
Note on standard	IP 44	IP 44	IP 44	IP 44
Installation	wall-mounted	wall-mounted	wall-mounted	wall-mounted
Scope of delivery	fastening set included	fastening set included	fastening set included	fastening set included
All colour combinations				

	VANITY UNIT	VANITY UNIT	VANITY UNIT	VANITY UNIT
Article number	F94Z YY XX	G94Z YY XX	F95Z YY XX	G95Z YY XX
Dimensions (w x h x d)	1200 x 603 x 501 mm	1200 x 603 x 501 mm	1200 x 603 x 501 mm	1200 x 603 x 501 mm
Version	with shelf unit (illuminated), with drilled tap holes washbasin on the middle	with shelf unit (illuminated), with wall lighting, with drilled tap holes washbasin on the middle	with shelf unit (illuminated), with drilled tap holes washbasin on the middle	with shelf unit (illuminated), with wall lighting, with drilled tap holes washbasin on the middle
For combination with	Artis 4198 61, 4179 43 Collaro 4A18 40	Artis 4198 61, 4179 43 Collaro 4A18 40	Artis 4198 61, 4179 43 Collaro 4A18 40	Artis 4198 61, 4179 43 Collaro 4A18 40
Lighting	LED lighting Lighting 1x LED / 2,3 W	LED lighting Lighting 1x LED / 2,3 W, 2x LED / 4,2 W	LED lighting Lighting 1x LED / 2,3 W	LED lighting Lighting 1x LED / 2,3 W, 2x LED / 4,2 W
Equipped with	1x Accessories package Finion 3x pull-out compartment with non-slip mat	1x Accessories package Finion 3x pull-out compartment with non-slip mat	1x Accessories package Finion 3x pull-out compartment with non-slip mat	1x Accessories package Finion 3x pull-out compartment with non-slip mat
Note on standard	IP 44	IP 44	IP 44	IP 44
Installation	wall-mounted	wall-mounted	wall-mounted	wall-mounted
Scope of delivery	fastening set included	fastening set included	fastening set included	fastening set included
All colour combinations				

To see how the article number is structured, refer to page 102

YY = Insert shelf colour
 GF = Glossy White Lacquer, GJ = Light Grey Matt Lacquer, GK = Anthracite Matt Lacquer, GM = Olive Matt Lacquer, HB = Peony Matt Lacquer, HF = Gold Matt Lacquer, HG = Midnight Blue Matt Lacquer, HH = Sand Matt Lacquer, MT = White Matt Lacquer, PD = Black Matt Lacquer, PH = Glossy Black Lacquer, GN = Walnut Veneer, PC = Oak Veneer

XX = Insert front and body colour
 GF = Glossy White Lacquer, GJ = Light Grey Matt Lacquer, GK = Anthracite Matt Lacquer, GM = Olive Matt Lacquer, HB = Peony Matt Lacquer, HG = Midnight Blue Matt Lacquer, HH = Sand Matt Lacquer, MT = White Matt Lacquer, PD = Black Matt Lacquer, PH = Glossy Black Lacquer, GN = Walnut Veneer, PC = Oak Veneer

Z = Insert colour code for cover panels
 1 = Glass White Matt, 2 = Glass Black Matt

FINION

FINION

€ excl. VAT

Registered design

Produced to order (Please note that it is not always possible to cancel or change orders!), The washbasins are to be ordered separately.

Express Delivery

These products are always in stock.

	VANITY UNIT	VANITY UNIT	VANITY UNIT	VANITY UNIT
Article number	F88Z 00 XX	G88Z 00 XX	F89Z YY XX	G89Z YY XX
Dimensions (w x h x d)	1000 x 603 x 501 mm	1000 x 603 x 501 mm	1000 x 603 x 501 mm	1000 x 603 x 501 mm
Version	with drilled tap holes washbasin on the middle	with wall lighting, with drilled tap holes washbasin on the middle	with shelf unit (illuminated), with drilled tap holes washbasin on the middle	with shelf unit (illuminated), with wall lighting, with drilled tap holes washbasin on the middle
For combination with	Artis 4198 61, 4179 43 Collaro 4A18 40	Artis 4198 61, 4179 43 Collaro 4A18 40	Artis 4198 61, 4179 43 Collaro 4A18 40	Artis 4198 61, 4179 43 Collaro 4A18 40
Lighting	-	LED lighting Lighting 2x LED / 4,2 W	LED lighting Lighting 1x LED / 2,3 W	LED lighting Lighting 1x LED / 2,3 W, 2x LED / 4,2 W
Equipped with	1x Accessories package Finion 2x pull-out compartment with non-slip mat	1x Accessories package Finion 2x pull-out compartment with non-slip mat	1x Accessories package Finion 2x pull-out compartment with non-slip mat	1x Accessories package Finion 2x pull-out compartment with non-slip mat
Note on standard	-	IP 44	IP 44	IP 44
Installation	wall-mounted	wall-mounted	wall-mounted	wall-mounted
Scope of delivery	fastening set included	fastening set included	fastening set included	fastening set included
All colour combinations				
	VANITY UNIT	VANITY UNIT	VANITY UNIT	VANITY UNIT
Article number	F90Z YY XX	G90Z YY XX	F87Z 00 XX	G87Z 00 XX
Dimensions (w x h x d)	1000 x 603 x 501 mm	1000 x 603 x 501 mm	800 x 603 x 501 mm	800 x 603 x 501 mm
Version	with shelf unit (illuminated), with drilled tap holes washbasin on the middle	with shelf unit (illuminated), with wall lighting, with drilled tap holes washbasin on the middle	with drilled tap holes washbasin on the middle	with wall lighting, with drilled tap holes washbasin on the middle
For combination with	Artis 4198 61, 4179 43 Collaro 4A18 40	Artis 4198 61, 4179 43 Collaro 4A18 40	Artis 4198 61, 4179 43 Collaro 4A18 40	Artis 4198 61, 4179 43 Collaro 4A18 40
Lighting	LED lighting Lighting 1x LED / 2,3 W	LED lighting Lighting 1x LED / 2,3 W, 2x LED / 4,2 W	-	LED lighting Lighting 2x LED / 4,2 W
Equipped with	1x Accessories package Finion 2x pull-out compartment with non-slip mat	1x Accessories package Finion 2x pull-out compartment with non-slip mat	1x Accessories package Finion 2x pull-out compartment with non-slip mat	1x Accessories package Finion 2x pull-out compartment with non-slip mat
Note on standard	IP 44	IP 44	-	IP 44
Installation	wall-mounted	wall-mounted	wall-mounted	wall-mounted
Scope of delivery	fastening set included	fastening set included	fastening set included	fastening set included
All colour combinations				

To see how the article number is structured, refer to page 102

YY = Insert shelf colour
 GF = Glossy White Lacquer, GJ = Light Grey Matt Lacquer, GK = Anthracite Matt Lacquer, GM = Olive Matt Lacquer, HB = Peony Matt Lacquer, HF = Gold Matt Lacquer, HG = Midnight Blue Matt Lacquer, HH = Sand Matt Lacquer, MT = White Matt Lacquer, PD = Black Matt Lacquer, PH = Glossy Black Lacquer, GN = Walnut Veneer, PC = Oak Veneer

XX = Insert front and body colour
 GF = Glossy White Lacquer, GJ = Light Grey Matt Lacquer, GK = Anthracite Matt Lacquer, GM = Olive Matt Lacquer, HB = Peony Matt Lacquer, HG = Midnight Blue Matt Lacquer, HH = Sand Matt Lacquer, MT = White Matt Lacquer, PD = Black Matt Lacquer, PH = Glossy Black Lacquer, GN = Walnut Veneer, PC = Oak Veneer

Z = Insert colour code for cover panels
 1 = Glass White Matt, 2 = Glass Black Matt

FINION

€ excl. VAT

Registered design

Produced to order (Please note that it is not always possible to cancel or change orders!), The washbasins are to be ordered separately.

Express Delivery These products are always in stock.

	VANITY UNIT	VANITY UNIT	VANITY UNIT	VANITY UNIT
Article number	FA8Z 00 XX	GA8Z 00 XX	FA9Z 00 XX	GA9Z 00 XX
Dimensions (w x h x d)	1600 x 603 x 501 mm	1600 x 603 x 501 mm	1600 x 603 x 501 mm	1600 x 603 x 501 mm
Version	without drilled tap holes for 2 washbasins	with wall lighting, without drilled tap holes for 2 washbasins	without drilled tap holes washbasin on the middle	with wall lighting, without drilled tap holes washbasin on the middle
For combination with	Artis 4179 43, 4198 61, 4172 58, 4178 41 Collaro 4A18 40, 4A21 38, 4A19 56, 4A20 56	Artis 4179 43, 4198 61, 4172 58, 4178 41 Collaro 4A18 40, 4A21 38, 4A19 56, 4A20 56	Artis 4179 43, 4198 61, 4172 58, 4178 41 Collaro 4A18 40, 4A21 38, 4A19 56, 4A20 56	Artis 4179 43, 4198 61, 4172 58, 4178 41 Collaro 4A18 40, 4A21 38, 4A19 56, 4A20 56
Lighting	-	LED lighting Lighting 2x LED / 4,2 W	-	LED lighting Lighting 2x LED / 4,2 W
Equipped with	2x Accessories package Finion 4x pull-out compartment with non-slip mat	2x Accessories package Finion 4x pull-out compartment with non-slip mat	2x Accessories package Finion 4x pull-out compartment with non-slip mat	2x Accessories package Finion 4x pull-out compartment with non-slip mat
Note on standard	-	IP 44	-	IP 44
Installation	wall-mounted	wall-mounted	wall-mounted	wall-mounted
Scope of delivery	fastening set included	fastening set included	fastening set included	fastening set included
All colour combinations				

	VANITY UNIT	VANITY UNIT	VANITY UNIT	VANITY UNIT
Article number	FD0Z YY XX	GD0Z YY XX	FA3Z 00 XX	GA3Z 00 XX
Dimensions (w x h x d)	1600 x 603 x 501 mm	1600 x 603 x 501 mm	1200 x 603 x 501 mm	1200 x 603 x 501 mm
Version	with shelf unit (illuminated), without drilled tap holes washbasin on the middle	with shelf unit (illuminated), with wall lighting, without drilled tap holes washbasin on the middle	without drilled tap holes washbasin on the middle	with wall lighting, without drilled tap holes washbasin on the middle
For combination with	Artis 4179 43, 4198 61, 4172 58, 4178 41 Collaro 4A18 40, 4A21 38, 4A19 56, 4A20 56	Artis 4179 43, 4198 61, 4172 58, 4178 41 Collaro 4A18 40, 4A21 38, 4A19 56, 4A20 56	Artis 4179 43, 4198 61, 4172 58, 4178 41 Collaro 4A18 40, 4A21 38, 4A19 56, 4A20 56	Artis 4179 43, 4198 61, 4172 58, 4178 41 Collaro 4A18 40, 4A21 38, 4A19 56, 4A20 56
Lighting	LED lighting Lighting 2x LED / 2,3 W	LED lighting Lighting 2x LED / 2,3 W, 2x LED / 4,2 W	-	LED lighting Lighting 2x LED / 4,2 W
Equipped with	1x Accessories package Finion 4x pull-out compartment with non-slip mat	1x Accessories package Finion 4x pull-out compartment with non-slip mat	2x Accessories package Finion 4x pull-out compartment with non-slip mat	2x Accessories package Finion 4x pull-out compartment with non-slip mat
Note on standard	IP 44	IP 44	-	IP 44
Installation	wall-mounted	wall-mounted	wall-mounted	wall-mounted
Scope of delivery	fastening set included	fastening set included	fastening set included	fastening set included
All colour combinations				

To see how the article number is structured, refer to page 102

YY = Insert shelf colour
 GF = Glossy White Lacquer, GJ = Light Grey Matt Lacquer, GK = Anthracite Matt Lacquer, GM = Olive Matt Lacquer, HB = Peony Matt Lacquer, HF = Gold Matt Lacquer, HG = Midnight Blue Matt Lacquer, HH = Sand Matt Lacquer, MT = White Matt Lacquer, PD = Black Matt Lacquer, PH = Glossy Black Lacquer, GN = Walnut Veneer, PC = Oak Veneer

XX = Insert front and body colour
 GF = Glossy White Lacquer, GJ = Light Grey Matt Lacquer, GK = Anthracite Matt Lacquer, GM = Olive Matt Lacquer, HB = Peony Matt Lacquer, HG = Midnight Blue Matt Lacquer, HH = Sand Matt Lacquer, MT = White Matt Lacquer, PD = Black Matt Lacquer, PH = Glossy Black Lacquer, GN = Walnut Veneer, PC = Oak Veneer

Z = Insert colour code for cover panels
 1 = Glass White Matt, 2 = Glass Black Matt

FINION



FINION



€ excl. VAT

Registered design

Produced to order (Please note that it is not always possible to cancel or change orders!), The washbasins are to be ordered separately.

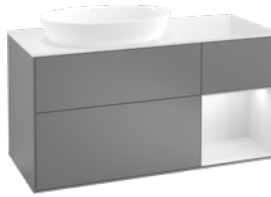
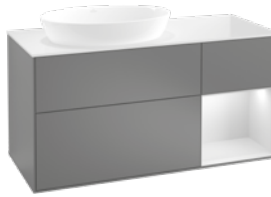
Express Delivery These products are always in stock.

	VANITY UNIT	VANITY UNIT	VANITY UNIT	VANITY UNIT
				
Article number	FA4Z YY XX	GA4Z YY XX	FA5Z YY XX	GA5Z YY XX
Dimensions (w x h x d)	1200 x 603 x 501 mm	1200 x 603 x 501 mm	1200 x 603 x 501 mm	1200 x 603 x 501 mm
Version	with shelf unit (illuminated), without drilled tap holes washbasin on right	with shelf unit (illuminated), with wall lighting, without drilled tap holes washbasin on right	with shelf unit (illuminated), without drilled tap holes washbasin on left	with shelf unit (illuminated), with wall lighting, without drilled tap holes washbasin on left
For combination with	Artis 4179 43, 4198 61, 4172 58, 4178 41 Collaro 4A18 40, 4A21 38, 4A19 56, 4A20 56	Artis 4179 43, 4198 61, 4172 58, 4178 41 Collaro 4A18 40, 4A21 38, 4A19 56, 4A20 56	Artis 4179 43, 4198 61, 4172 58, 4178 41 Collaro 4A18 40, 4A21 38, 4A19 56, 4A20 56	Artis 4179 43, 4198 61, 4172 58, 4178 41 Collaro 4A18 40, 4A21 38, 4A19 56, 4A20 56
Lighting	LED lighting Lighting 1x LED / 2,3 W	LED lighting Lighting 1x LED / 2,3 W, 2x LED / 4,2 W	LED lighting Lighting 1x LED / 2,3 W	LED lighting Lighting 1x LED / 2,3 W, 2x LED / 4,2 W
Equipped with	1x Accessories package Finion 3x pull-out compartment with non-slip mat	1x Accessories package Finion 3x pull-out compartment with non-slip mat	1x Accessories package Finion 3x pull-out compartment with non-slip mat	1x Accessories package Finion 3x pull-out compartment with non-slip mat
Note on standard	IP 44	IP 44	IP 44	IP 44
Installation	wall-mounted	wall-mounted	wall-mounted	wall-mounted
Scope of delivery	fastening set included	fastening set included	fastening set included	fastening set included
All colour combinations				

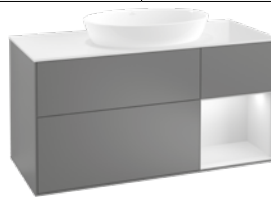
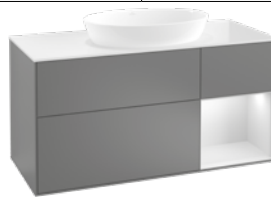
	VANITY UNIT	VANITY UNIT	VANITY UNIT	VANITY UNIT
				
Article number	FA6Z YY XX	GA6Z YY XX	FA7Z YY XX	GA7Z YY XX
Dimensions (w x h x d)	1200 x 603 x 501 mm	1200 x 603 x 501 mm	1200 x 603 x 501 mm	1200 x 603 x 501 mm
Version	with shelf unit (illuminated), without drilled tap holes washbasin on the middle	with shelf unit (illuminated), with wall lighting, without drilled tap holes washbasin on the middle	with shelf unit (illuminated), without drilled tap holes washbasin on the middle	with shelf unit (illuminated), with wall lighting, without drilled tap holes washbasin on the middle
For combination with	Artis 4179 43, 4198 61, 4172 58, 4178 41 Collaro 4A18 40, 4A21 38, 4A19 56, 4A20 56	Artis 4179 43, 4198 61, 4172 58, 4178 41 Collaro 4A18 40, 4A21 38, 4A19 56, 4A20 56	Artis 4179 43, 4198 61, 4172 58, 4178 41 Collaro 4A18 40, 4A21 38, 4A19 56, 4A20 56	Artis 4179 43, 4198 61, 4172 58, 4178 41 Collaro 4A18 40, 4A21 38, 4A19 56, 4A20 56
Lighting	LED lighting Lighting 1x LED / 2,3 W	LED lighting Lighting 1x LED / 2,3 W, 2x LED / 4,2 W	LED lighting Lighting 1x LED / 2,3 W	LED lighting Lighting 1x LED / 2,3 W, 2x LED / 4,2 W
Equipped with	1x Accessories package Finion 3x pull-out compartment with non-slip mat	1x Accessories package Finion 3x pull-out compartment with non-slip mat	1x Accessories package Finion 3x pull-out compartment with non-slip mat	1x Accessories package Finion 3x pull-out compartment with non-slip mat
Note on standard	IP 44	IP 44	IP 44	IP 44
Installation	wall-mounted	wall-mounted	wall-mounted	wall-mounted
Scope of delivery	fastening set included	fastening set included	fastening set included	fastening set included
All colour combinations				

To see how the article number is structured, refer to page 102

YY = Insert shelf colour
 GF = Glossy White Lacquer, GJ = Light Grey Matt Lacquer, GK = Anthracite Matt Lacquer, GM = Olive Matt Lacquer, HB = Peony Matt Lacquer, HF = Gold Matt Lacquer, HG = Midnight Blue Matt Lacquer, HH = Sand Matt Lacquer, MT = White Matt Lacquer, PD = Black Matt Lacquer, PH = Glossy Black Lacquer, GN = Walnut Veneer, PC = Oak Veneer

XX = Insert front and body colour
 GF = Glossy White Lacquer, GJ = Light Grey Matt Lacquer, GK = Anthracite Matt Lacquer, GM = Olive Matt Lacquer, HB = Peony Matt Lacquer, HG = Midnight Blue Matt Lacquer, HH = Sand Matt Lacquer, MT = White Matt Lacquer, PD = Black Matt Lacquer, PH = Glossy Black Lacquer, GN = Walnut Veneer, PC = Oak Veneer

Z = Insert colour code for cover panels
 1 = Glass White Matt, 2 = Glass Black Matt

FINION





€ excl. VAT





Registered design

Produced to order (Please note that it is not always possible to cancel or change orders!), The washbasins are to be ordered separately.

Express Delivery

These products are always in stock.

	VANITY UNIT	VANITY UNIT	VANITY UNIT	VANITY UNIT
				
Article number	FA0Z 00 XX	GA0Z 00 XX	FA1Z YY XX	GA1Z YY XX
Dimensions (w x h x d)	1000 x 603 x 501 mm	1000 x 603 x 501 mm	1000 x 603 x 501 mm	1000 x 603 x 501 mm
Version	without drilled tap holes washbasin on the middle	with wall lighting, without drilled tap holes washbasin on the middle	with shelf unit (illuminated), without drilled tap holes washbasin on the middle	with shelf unit (illuminated), with wall lighting, without drilled tap holes washbasin on the middle
For combination with	Artis 4179 43, 4198 61, 4172 58, 4178 41 Collaro 4A18 40, 4A21 38, 4A19 56, 4A20 56	Artis 4179 43, 4198 61, 4172 58, 4178 41 Collaro 4A18 40, 4A21 38, 4A19 56, 4A20 56	Artis 4179 43, 4198 61, 4172 58, 4178 41 Collaro 4A18 40, 4A21 38, 4A19 56, 4A20 56	Artis 4179 43, 4198 61, 4172 58, 4178 41 Collaro 4A18 40, 4A21 38, 4A19 56, 4A20 56
Lighting	-	LED lighting Lighting 2x LED / 4,2 W	LED lighting Lighting 1x LED / 2,3 W	LED lighting Lighting 1x LED / 2,3 W, 2x LED / 4,2 W
Equipped with	1x Accessories package Finion 2x pull-out compartment with non-slip mat	1x Accessories package Finion 2x pull-out compartment with non-slip mat	1x Accessories package Finion 2x pull-out compartment with non-slip mat	1x Accessories package Finion 2x pull-out compartment with non-slip mat
Note on standard	-	IP 44	IP 44	IP 44
Installation	wall-mounted	wall-mounted	wall-mounted	wall-mounted
Scope of delivery	fastening set included	fastening set included	fastening set included	fastening set included
All colour combinations				

	VANITY UNIT	VANITY UNIT	VANITY UNIT	VANITY UNIT
				
Article number	FA2Z YY XX	GA2Z YY XX	F99Z 00 XX	G99Z 00 XX
Dimensions (w x h x d)	1000 x 603 x 501 mm	1000 x 603 x 501 mm	800 x 603 x 501 mm	800 x 603 x 501 mm
Version	with shelf unit (illuminated), without drilled tap holes washbasin on the middle	with shelf unit (illuminated), with wall lighting, without drilled tap holes washbasin on the middle	without drilled tap holes washbasin on the middle	with wall lighting, without drilled tap holes washbasin on the middle
For combination with	Artis 4179 43, 4198 61, 4172 58, 4178 41 Collaro 4A18 40, 4A21 38, 4A19 56, 4A20 56	Artis 4179 43, 4198 61, 4172 58, 4178 41 Collaro 4A18 40, 4A21 38, 4A19 56, 4A20 56	Artis 4179 43, 4198 61, 4172 58, 4178 41 Collaro 4A18 40, 4A21 38, 4A19 56, 4A20 56	Artis 4179 43, 4198 61, 4172 58, 4178 41 Collaro 4A18 40, 4A21 38, 4A19 56, 4A20 56
Lighting	LED lighting Lighting 1x LED / 2,3 W	LED lighting Lighting 1x LED / 2,3 W, 2x LED / 4,2 W	-	LED lighting Lighting 2x LED / 4,2 W
Equipped with	1x Accessories package Finion 2x pull-out compartment with non-slip mat	1x Accessories package Finion 2x pull-out compartment with non-slip mat	1x Accessories package Finion 2x pull-out compartment with non-slip mat	1x Accessories package Finion 2x pull-out compartment with non-slip mat
Note on standard	IP 44	IP 44	-	IP 44
Installation	wall-mounted	wall-mounted	wall-mounted	wall-mounted
Scope of delivery	fastening set included	fastening set included	fastening set included	fastening set included
All colour combinations				

To see how the article number is structured, refer to page 102

YY = Insert shelf colour
GF = Glossy White Lacquer, GJ = Light Grey Matt Lacquer, GK = Anthracite Matt Lacquer, GM = Olive Matt Lacquer, HB = Peony Matt Lacquer, HF = Gold Matt Lacquer, HG = Midnight Blue Matt Lacquer, HH = Sand Matt Lacquer, MT = White Matt Lacquer, PD = Black Matt Lacquer, PH = Glossy Black Lacquer, GN = Walnut Veneer, PC = Oak Veneer

XX = Insert front and body colour
GF = Glossy White Lacquer, GJ = Light Grey Matt Lacquer, GK = Anthracite Matt Lacquer, GM = Olive Matt Lacquer, HB = Peony Matt Lacquer, HG = Midnight Blue Matt Lacquer, HH = Sand Matt Lacquer, MT = White Matt Lacquer, PD = Black Matt Lacquer, PH = Glossy Black Lacquer, GN = Walnut Veneer, PC = Oak Veneer

Z = Insert colour code for cover panels
1 = Glass White Matt, 2 = Glass Black Matt

FINION

FINION









€ excl. VAT

Registered design

Produced to order (Please note that it is not always possible to cancel or change orders!), The washbasins are to be ordered separately.

Express Delivery

These products are always in stock.

	TALL CABINET	TALL CABINET	TALL CABINET	TALL CABINET
				
Article number	F480 00 XX	G480 00 XX	F490 00 XX	G490 00 XX
Dimensions (w x h x d)	418 x 1516 x 270 mm	418 x 1516 x 270 mm	418 x 1516 x 270 mm	418 x 1516 x 270 mm
Version	-	with wall lighting	-	with wall lighting
Hinges	hinges on left	hinges on left	hinges on right	hinges on right
Lighting	-	LED lighting Lighting 2x LED / 11,2 W	-	LED lighting Lighting 2x LED / 11,2 W
Equipped with	1x fixed shelf 1x door 3x glass shelf	1x fixed shelf 1x door 3x glass shelf	1x fixed shelf 1x door 3x glass shelf	1x fixed shelf 1x door 3x glass shelf
Note on standard	-	IP 44	-	IP 44
Installation	wall-mounted	wall-mounted	wall-mounted	wall-mounted
Scope of delivery	fastening set included	fastening set included	fastening set included	fastening set included
All colour combinations				
	TALL CABINET	TALL CABINET	TALL CABINET	TALL CABINET
				
Article number	F460 YY XX	G460 YY XX	F470 YY XX	G470 YY XX
Dimensions (w x h x d)	418 x 1516 x 270 mm	418 x 1516 x 270 mm	418 x 1516 x 270 mm	418 x 1516 x 270 mm
Version	with shelf unit (illuminated)	with shelf unit (illuminated), with wall lighting	with shelf unit (illuminated)	with shelf unit (illuminated), with wall lighting
Hinges	hinges on left	hinges on left	hinges on right	hinges on right
Lighting	LED lighting Lighting 1x LED / 2,3 W	LED lighting Lighting 1x LED / 2,3 W, 2x LED / 11,2 W	LED lighting Lighting 1x LED / 2,3 W	LED lighting Lighting 1x LED / 2,3 W, 2x LED / 11,2 W
Equipped with	2x door 2x glass shelf	2x door 2x glass shelf	2x door 2x glass shelf	2x door 2x glass shelf
Note on standard	IP 44	IP 44	IP 44	IP 44
Installation	wall-mounted	wall-mounted	wall-mounted	wall-mounted
Scope of delivery	fastening set included	fastening set included	fastening set included	fastening set included
All colour combinations				

To see how the article number is structured, refer to page 102

YY = Insert shelf colour

GF = Glossy White Lacquer, GJ = Light Grey Matt Lacquer, GK = Anthracite Matt Lacquer, GM = Olive Matt Lacquer, HB = Peony Matt Lacquer, HF = Gold Matt Lacquer, HG = Midnight Blue Matt Lacquer, HH = Sand Matt Lacquer, MT = White Matt Lacquer, PD = Black Matt Lacquer, PH = Glossy Black Lacquer, GN = Walnut Veneer, PC = Oak Veneer

XX = Insert front and body colour

GF = Glossy White Lacquer, GJ = Light Grey Matt Lacquer, GK = Anthracite Matt Lacquer, GM = Olive Matt Lacquer, HB = Peony Matt Lacquer, HG = Midnight Blue Matt Lacquer, HH = Sand Matt Lacquer, MT = White Matt Lacquer, PD = Black Matt Lacquer, PH = Glossy Black Lacquer, GN = Walnut Veneer, PC = Oak Veneer

Z = Insert colour code for cover panels

1 = Glass White Matt, 2 = Glass Black Matt





FINION





€ excl. VAT

Registered design

Produced to order (Please note that it is not always possible to cancel or change orders!), The washbasins are to be ordered separately.

Express Delivery These products are always in stock.

	SIDE CABINET	SIDE CABINET	SIDE CABINET	SIDE CABINET
				
Article number	F560 00 XX	G560 00 XX	F570 00 XX	G570 00 XX
Dimensions (w x h x d)	418 x 936 x 270 mm	418 x 936 x 270 mm	418 x 936 x 270 mm	418 x 936 x 270 mm
Version	-	with wall lighting	-	with wall lighting
Hinges	hinges on left	hinges on left	hinges on right	hinges on right
Lighting	-	LED lighting Lighting 2x LED / 6,9 W	-	LED lighting Lighting 2x LED / 6,9 W
Equipped with	1x door 2x glass shelf	1x door 2x glass shelf	1x door 2x glass shelf	1x door 2x glass shelf
Note on standard	-	IP 44	-	IP 44
Installation	wall-mounted	wall-mounted	wall-mounted	wall-mounted
Scope of delivery	fastening set included	fastening set included	fastening set included	fastening set included
All colour combinations				

	SIDE CABINET	SIDE CABINET	SIDE CABINET	SIDE CABINET
				
Article number	F500 YY XX	G500 YY XX	F510 YY XX	G510 YY XX
Dimensions (w x h x d)	418 x 936 x 270 mm	418 x 936 x 270 mm	418 x 936 x 270 mm	418 x 936 x 270 mm
Version	with shelf unit (illuminated)	with shelf unit (illuminated), with wall lighting	with shelf unit (illuminated)	with shelf unit (illuminated), with wall lighting
Hinges	hinges on left	hinges on left	hinges on right	hinges on right
Lighting	LED lighting Lighting 1x LED / 2,3 W	LED lighting Lighting 1x LED / 2,3 W, 2x LED / 6,9 W	LED lighting Lighting 1x LED / 2,3 W	LED lighting Lighting 1x LED / 2,3 W, 2x LED / 6,9 W
Equipped with	1x door 1x glass shelf	1x door 1x glass shelf	1x door 1x glass shelf	1x door 1x glass shelf
Note on standard	IP 44	IP 44	IP 44	IP 44
Installation	wall-mounted	wall-mounted	wall-mounted	wall-mounted
Scope of delivery	fastening set included	fastening set included	fastening set included	fastening set included
All colour combinations				

FINION

To see how the article number is structured, refer to page 102

YY = Insert shelf colour
 GF = Glossy White Lacquer, GJ = Light Grey Matt Lacquer, GK = Anthracite Matt Lacquer, GM = Olive Matt Lacquer, HB = Peony Matt Lacquer, HF = Gold Matt Lacquer, HG = Midnight Blue Matt Lacquer, HH = Sand Matt Lacquer, MT = White Matt Lacquer, PD = Black Matt Lacquer, PH = Glossy Black Lacquer, GN = Walnut Veneer, PC = Oak Veneer

XX = Insert front and body colour
 GF = Glossy White Lacquer, GJ = Light Grey Matt Lacquer, GK = Anthracite Matt Lacquer, GM = Olive Matt Lacquer, HB = Peony Matt Lacquer, HG = Midnight Blue Matt Lacquer, HH = Sand Matt Lacquer, MT = White Matt Lacquer, PD = Black Matt Lacquer, PH = Glossy Black Lacquer, GN = Walnut Veneer, PC = Oak Veneer

Z = Insert colour code for cover panels
 1 = Glass White Matt, 2 = Glass Black Matt









FINION

€ excl. VAT

Registered design

Produced to order (Please note that it is not always possible to cancel or change orders!), The washbasins are to be ordered separately.

Express Delivery These products are always in stock.

	SIDE CABINET	SIDE CABINET	SIDE CABINET	SIDE CABINET
				
Article number	F520 YY XX	G520 YY XX	F530 YY XX	G530 YY XX
Dimensions (w x h x d)	418 x 936 x 270 mm	418 x 936 x 270 mm	418 x 936 x 270 mm	418 x 936 x 270 mm
Version	with shelf unit (illuminated), with charging station	with shelf unit (illuminated), with charging station, with wall lighting	with shelf unit (illuminated), with charging station	with shelf unit (illuminated), with charging station, with wall lighting
Hinges	hinges on left	hinges on left	hinges on right	hinges on right
Lighting	LED lighting Lighting 1x LED / 2,3 W	LED lighting Lighting 1x LED / 2,3 W, 2x LED / 6,9 W	LED lighting Lighting 1x LED / 2,3 W	LED lighting Lighting 1x LED / 2,3 W, 2x LED / 6,9 W
Equipped with	1x door 1x glass shelf	1x door 1x glass shelf	1x door 1x glass shelf	1x door 1x glass shelf
Note on standard	IP 44	IP 44	IP 44	IP 44
Installation	wall-mounted	wall-mounted	wall-mounted	wall-mounted
Scope of delivery	fastening set included	fastening set included	fastening set included	fastening set included
All colour combinations				
	SIDE CABINET	SIDE CABINET	SIDE CABINET	SIDE CABINET
				
Article number	F540 YY XX	G540 YY XX	F550 YY XX	G550 YY XX
Dimensions (w x h x d)	418 x 936 x 270 mm	418 x 936 x 270 mm	418 x 936 x 270 mm	418 x 936 x 270 mm
Version	with shelf unit (illuminated)	with shelf unit (illuminated), with wall lighting	with shelf unit (illuminated)	with shelf unit (illuminated), with wall lighting
Hinges	hinges on left	hinges on left	hinges on right	hinges on right
Lighting	LED lighting Lighting 1x LED / 2,3 W	LED lighting Lighting 1x LED / 2,3 W, 2x LED / 6,9 W	LED lighting Lighting 1x LED / 2,3 W	LED lighting Lighting 1x LED / 2,3 W, 2x LED / 6,9 W
Equipped with	1x door 1x glass shelf	1x door 1x glass shelf	1x door 1x glass shelf	1x door 1x glass shelf
Note on standard	IP 44	IP 44	IP 44	IP 44
Installation	wall-mounted	wall-mounted	wall-mounted	wall-mounted
Scope of delivery	fastening set included	fastening set included	fastening set included	fastening set included
All colour combinations				

To see how the article number is structured, refer to page 102

YY = Insert shelf colour
 GF = Glossy White Lacquer, GJ = Light Grey Matt Lacquer, GK = Anthracite Matt Lacquer, GM = Olive Matt Lacquer, HB = Peony Matt Lacquer, HF = Gold Matt Lacquer, HG = Midnight Blue Matt Lacquer, HH = Sand Matt Lacquer, MT = White Matt Lacquer, PD = Black Matt Lacquer, PH = Glossy Black Lacquer, GN = Walnut Veneer, PC = Oak Veneer

XX = Insert front and body colour
 GF = Glossy White Lacquer, GJ = Light Grey Matt Lacquer, GK = Anthracite Matt Lacquer, GM = Olive Matt Lacquer, HB = Peony Matt Lacquer, HG = Midnight Blue Matt Lacquer, HH = Sand Matt Lacquer, MT = White Matt Lacquer, PD = Black Matt Lacquer, PH = Glossy Black Lacquer, GN = Walnut Veneer, PC = Oak Veneer

Z = Insert colour code for cover panels
 1 = Glass White Matt, 2 = Glass Black Matt

FINION

€ excl. VAT

Registered design

Produced to order (Please note that it is not always possible to cancel or change orders!), The washbasins are to be ordered separately.

Express Delivery These products are always in stock.

	SHELF MODULE	SHELF MODULE	SHELF MODULE	SHELF MODULE
Article number	FD10 YY XX	F580 YY XX	G580 YY XX	F590 YY XX
Dimensions (w x h x d)	418 x 356 x 270 mm	418 x 356 x 270 mm	418 x 356 x 270 mm	418 x 356 x 270 mm
Version	-	interior lighting	interior lighting, with wall lighting	interior lighting, with charging station
Lighting	-	LED lighting Lighting 1x LED / 2,3 W	LED lighting Lighting 3x LED / 2,3 W	LED lighting Lighting 1x LED / 2,3 W
Note on standard	-	IP 44	IP 44	IP 44
Installation	wall-mounted	wall-mounted	wall-mounted	wall-mounted
Scope of delivery	fastening set included	fastening set included	fastening set included	fastening set included
All colour combinations				

	SHELF MODULE
Article number	G590 YY XX
Dimensions (w x h x d)	418 x 356 x 270 mm
Version	interior lighting, with charging station, with wall lighting
Lighting	LED lighting Lighting 3x LED / 2,3 W
Note on standard	IP 44
Installation	wall-mounted
Scope of delivery	fastening set included
All colour combinations	

	MIRROR	MIRROR	MIRROR	MIRROR
Article number	F620 16 00	F620 12 00	F620 10 00	F620 80 00
Dimensions (w x h x d)	1600 x 1000 x 20 mm	1200 x 1000 x 20 mm	1000 x 1000 x 20 mm	800 x 1000 x 20 mm
Version	with faceted cut	with faceted cut	with faceted cut	with faceted cut
Scope of delivery	fastening set included	fastening set included	fastening set included	fastening set included
All colour combinations				

To see how the article number is structured, refer to page 102

YY = Insert shelf colour
 GF = Glossy White Lacquer, GJ = Light Grey Matt Lacquer, GK = Anthracite Matt Lacquer, GM = Olive Matt Lacquer, HB = Peony Matt Lacquer, HF = Gold Matt Lacquer, HG = Midnight Blue Matt Lacquer, HH = Sand Matt Lacquer, MT = White Matt Lacquer, PD = Black Matt Lacquer, PH = Glossy Black Lacquer, GN = Walnut Veneer, PC = Oak Veneer

XX = Insert front and body colour
 GF = Glossy White Lacquer, GJ = Light Grey Matt Lacquer, GK = Anthracite Matt Lacquer, GM = Olive Matt Lacquer, HB = Peony Matt Lacquer, HG = Midnight Blue Matt Lacquer, HH = Sand Matt Lacquer, MT = White Matt Lacquer, PD = Black Matt Lacquer, PH = Glossy Black Lacquer, GN = Walnut Veneer, PC = Oak Veneer

Z = Insert colour code for cover panels
 1 = Glass White Matt, 2 = Glass Black Matt

FINION

FINION



€ excl. VAT

Registered design

Produced to order (Please note that it is not always possible to cancel or change orders!), The washbasins are to be ordered separately.

Express Delivery These products are always in stock.

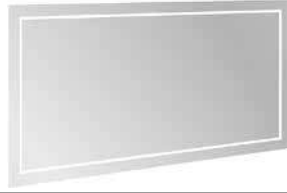
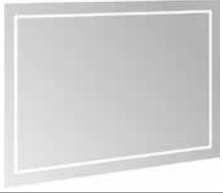
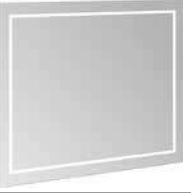
MIRROR	
	
Express Delivery	
Article number	F620 60 00
Dimensions (w x h x d)	600 x 1000 x 20 mm
Version	with faceted cut
Scope of delivery	fastening set included

MIRROR		MIRROR		MIRROR		MIRROR	
							
Express Delivery		Express Delivery		Express Delivery		Express Delivery	
Article number	F600 16 00	Article number	F600 12 00	Article number	F600 10 00	Article number	F600 80 00
Dimensions (w x h x d)	1600 x 750 x 45 mm	Dimensions (w x h x d)	1200 x 750 x 45 mm	Dimensions (w x h x d)	1000 x 750 x 45 mm	Dimensions (w x h x d)	800 x 750 x 45 mm
Lighting	LED lighting Lighting 1x LED / 66,2 W	Lighting	LED lighting Lighting 1x LED / 53,9 W	Lighting	LED lighting Lighting 1x LED / 47,7 W	Lighting	LED lighting Lighting 1x LED / 41,6 W
Note on standard	IP 44	Note on standard	IP 44	Note on standard	IP 44	Note on standard	IP 44
Scope of delivery	fastening set included	Scope of delivery	fastening set included	Scope of delivery	fastening set included	Scope of delivery	fastening set included

MIRROR	
	
Express Delivery	
Article number	F600 60 00
Dimensions (w x h x d)	600 x 750 x 45 mm
Lighting	LED lighting Lighting 1x LED / 35,4 W
Note on standard	IP 44
Scope of delivery	fastening set included

To see how the article number is structured, refer to page 102

YY = Insert shelf colour
 GF = Glossy White Lacquer, GJ = Light Grey Matt Lacquer, GK = Anthracite Matt Lacquer, GM = Olive Matt Lacquer, HB = Peony Matt Lacquer, HF = Gold Matt Lacquer, HG = Midnight Blue Matt Lacquer, HH = Sand Matt Lacquer, MT = White Matt Lacquer, PD = Black Matt Lacquer, PH = Glossy Black Lacquer, GN = Walnut Veneer, PC = Oak Veneer

XX = Insert front and body colour
 GF = Glossy White Lacquer, GJ = Light Grey Matt Lacquer, GK = Anthracite Matt Lacquer, GM = Olive Matt Lacquer, HB = Peony Matt Lacquer, HG = Midnight Blue Matt Lacquer, HH = Sand Matt Lacquer, MT = White Matt Lacquer, PD = Black Matt Lacquer, PH = Glossy Black Lacquer, GN = Walnut Veneer, PC = Oak Veneer

Z = Insert colour code for cover panels
 1 = Glass White Matt, 2 = Glass Black Matt

FINION

€ excl. VAT

Registered design

Produced to order (Please note that it is not always possible to cancel or change orders!), The washbasins are to be ordered separately.

Express Delivery These products are always in stock.

	MIRROR	MIRROR	MIRROR	MIRROR
Article number	G600 16 00	G600 12 00	G600 10 00	G600 80 00
Dimensions (w x h x d)	1600 x 750 x 45 mm	1200 x 750 x 45 mm	1000 x 750 x 45 mm	800 x 750 x 45 mm
Lighting	LED lighting Lighting 1x LED / 33,1 W, 1x LED / 66,2 W	LED lighting Lighting 1x LED / 27 W, 1x LED / 53,9 W	LED lighting Lighting 1x LED / 23,9 W, 1x LED / 47,7 W	LED lighting Lighting 1x LED / 20,8 W, 1x LED / 41,6 W
Equipped with	with wall lighting	with wall lighting	with wall lighting	with wall lighting
Note on standard	IP 44	IP 44	IP 44	IP 44
Scope of delivery	fastening set included	fastening set included	fastening set included	fastening set included

	MIRROR
Article number	G600 60 00
Dimensions (w x h x d)	600 x 750 x 45 mm
Lighting	LED lighting Lighting 1x LED / 17,7 W, 1x LED / 35,4 W
Equipped with	with wall lighting
Note on standard	IP 44
Scope of delivery	fastening set included

	MIRROR	MIRROR	MIRROR	MIRROR
Article number	G610 16 00	G610 12 00	G610 10 00	G610 80 00
Dimensions (w x h x d)	1600 x 750 x 45 mm	1200 x 750 x 45 mm	1000 x 750 x 45 mm	800 x 750 x 45 mm
Lighting	LED lighting Lighting 1x LED / 33,1 W, 1x LED / 66,2 W	LED lighting Lighting 1x LED / 27 W, 1x LED / 53,9 W	LED lighting Lighting 1x LED / 23,9 W, 1x LED / 47,7 W	LED lighting Lighting 1x LED / 20,8 W, 1x LED / 41,6 W
Equipped with	Sound system with Bluetooth® wireless transmission with wall lighting mirror heating	Sound system with Bluetooth® wireless transmission with wall lighting mirror heating	Sound system with Bluetooth® wireless transmission with wall lighting mirror heating	Sound system with Bluetooth® wireless transmission with wall lighting mirror heating
Note on standard	IP 44	IP 44	IP 44	IP 44
Scope of delivery	fastening set included	fastening set included	fastening set included	fastening set included

To see how the article number is structured, refer to page 102

YY = Insert shelf colour
 GF = Glossy White Lacquer, GJ = Light Grey Matt Lacquer, GK = Anthracite Matt Lacquer, GM = Olive Matt Lacquer, HB = Peony Matt Lacquer, HF = Gold Matt Lacquer, HG = Midnight Blue Matt Lacquer, HH = Sand Matt Lacquer, MT = White Matt Lacquer, PD = Black Matt Lacquer, PH = Glossy Black Lacquer, GN = Walnut Veneer, PC = Oak Veneer

XX = Insert front and body colour
 GF = Glossy White Lacquer, GJ = Light Grey Matt Lacquer, GK = Anthracite Matt Lacquer, GM = Olive Matt Lacquer, HB = Peony Matt Lacquer, HG = Midnight Blue Matt Lacquer, HH = Sand Matt Lacquer, MT = White Matt Lacquer, PD = Black Matt Lacquer, PH = Glossy Black Lacquer, GN = Walnut Veneer, PC = Oak Veneer

Z = Insert colour code for cover panels
 1 = Glass White Matt, 2 = Glass Black Matt

FINION





FINION



€ excl. VAT

Registered design

Produced to order (Please note that it is not always possible to cancel or change orders!), The washbasins are to be ordered separately.

Express Delivery These products are always in stock.

MIRROR	
	
  	
Article number	G610 60 00
Dimensions (w x h x d)	600 x 750 x 45 mm
Lighting	LED lighting Lighting 1x LED / 17,7 W, 1x LED / 35,4 W
Equipped with	Sound system with Bluetooth® wireless transmission with wall lighting mirror heating
Note on standard	IP 44
Scope of delivery	fastening set included

REMOTE CONTROL, INCLUDING MOUNT	
	
	
Article number	G999 02 00
Dimensions (w x h x d)	40 x 10 x 115 mm
Description	one remote control for all Collaro and Finion articles, is required to operate all Collaro and Finion lighting elements
Scope of delivery	not included in scope of delivery

To see how the article number is structured, refer to page 102

YY = Insert shelf colour
 GF = Glossy White Lacquer, GJ = Light Grey Matt Lacquer, GK = Anthracite Matt Lacquer, GM = Olive Matt Lacquer, HB = Peony Matt Lacquer, HF = Gold Matt Lacquer, HG = Midnight Blue Matt Lacquer, HH = Sand Matt Lacquer, MT = White Matt Lacquer, PD = Black Matt Lacquer, PH = Glossy Black Lacquer, GN = Walnut Veneer, PC = Oak Veneer

XX = Insert front and body colour
 GF = Glossy White Lacquer, GJ = Light Grey Matt Lacquer, GK = Anthracite Matt Lacquer, GM = Olive Matt Lacquer, HB = Peony Matt Lacquer, HG = Midnight Blue Matt Lacquer, HH = Sand Matt Lacquer, MT = White Matt Lacquer, PD = Black Matt Lacquer, PH = Glossy Black Lacquer, GN = Walnut Veneer, PC = Oak Veneer

Z = Insert colour code for cover panels
 1 = Glass White Matt, 2 = Glass Black Matt

HOMMAGE

Sanitaryware and Bathroom Furniture

- Premium segment
- Matching furniture programme Hommage
- Matching bath: Hommage

PRO.VILLEROY-BOCH.COM/TECHNICALDRAWINGS



Ceramic colours



R1 = White Alpin
CeramicPlus

Front- / Body colours



Walnut/Grey-
White Marble



White Matt
Lacquer/Black
Marble

HOMMAGE

€ excl. VAT

Registered design

Please order tap fittings and soap dispenser separately

BUILT-IN WASHBASIN

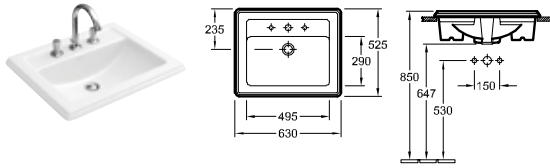

Article number	Description	plus R1		pcs/ pal.	kg/ pc.
7102 63 XX	630 x 525 mm		-	10	21,1
7102 A1 XX	630 x 525 mm		-	24	21

incl. template, matching furniture programme: Hommage

For further information about matching valves, see pages 380-383

WASHDOWN TOILET

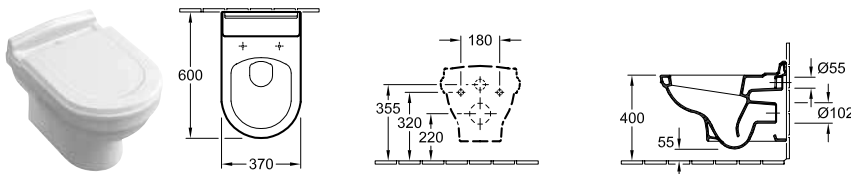

Article number	Description	plus R1		pcs/ pal.	kg/ pc.
6661 B0 XX	370 x 600 mm		-	10	28,1

wall-mounted, horizontal outlet, with fastening set for concealed fastening

8809 S1 XX	TOILET SEAT AND COVER with QuickRelease and SoftClosing hinges, hinges in stainless steel		-	40	3,971
8809 S6 XX	TOILET SEAT AND COVER with QuickRelease and SoftClosing hinges, noble brass hinges		-	40	3,85
9926 K1 00	TOILET SEAT AND COVER solid birch, stained walnut, hinges in stainless steel		-	40	3,5
9926 K6 00	TOILET SEAT AND COVER solid birch, stained walnut, noble brass hinges		-	40	3,5
9222 87 00	VIPROTECT SOUNDPROOFING SET (optional) incl. accessories		-	600	0,086
9224 27 00	TOILET INSTALLATION SYSTEM for dry-wall construction, standard height 525 x 1120 x 135 mm For further ViConnect models, see pages 368-379		-	10	15,8
9224 65 00	TOILET INSTALLATION SYSTEM for dry-wall construction, low 450 x 1120 x 165 mm For further ViConnect models, see pages 368-379		-	8	19,78

XX = Colour code to be indicated
R1 = White Alpin CeramicPlus

HOMMAGE

€ excl. VAT

Registered design

Goods in stock

Express Delivery These products are always in stock.

Front:

solid maple in stained Walnut or White Matt Lacquer (21 mm)
interior colour = exterior colour
continuous grain in Walnut

Body:

direct-laminated chipboard in Walnut or White Matt (19 mm)
interior colour = exterior colour
vertical grain in Walnut

Washbasin countertop:

Marble in Grey-White Marble for Walnut (30 mm)

Marble in Black Marble for White Matt Lacquer (30 mm)

Doors:

with glass inset
SoftClosing feature

Handles:





Ceramic in 01

Mirrors:

Mirror (5 mm) bonded to frame
veneered chipboard (19 mm) in stained Walnut, in matt white lacquered finish

Please note:

For further information such as tap fitting positions, installation and fastening dimensions etc. please see the technical drawings.

	HANDLE	
		
Colour	ceramic handle square, white	
	VANITY UNIT WITH WASHBASIN	VANITY UNIT WITH WASHBASIN
		
		
Article number	8979 63 XX	8979 A1 XX
Dimensions (w x h x d)	985 x 905 x 620 mm	985 x 905 x 620 mm
Version	washbasin on the middle	washbasin on the middle
Equipped with	1x drawer 2x door 1x shelf 1x marble countertop with ledge	1x drawer 2x door 1x shelf 1x marble countertop with ledge
Installation	floor-standing	floor-standing
Scope of delivery	Vanity unit, Built-in washbasin 7102 63, square handles to match ceramics, fastening set included	Vanity unit, Built-in washbasin 7102 A1, square handles to match ceramics, fastening set included
R1		

HOMMAGE

XX = Colour code to be indicated
R1 = White Alpin CeramicPlus

YY = Insert code for handle
01 = White Alpin

HOMMAGE



€ excl. VAT

Registered design

Goods in stock

Express Delivery These products are always in stock.

	SIDE CABINET	SIDE CABINET
		
	Express Delivery	Express Delivery
Article number	8964 10 YY	8964 11 YY
Dimensions (w x h x d)	442 x 850 x 432 mm	442 x 850 x 432 mm
Hinges	hinges on left	hinges on right
Equipped with	1x drawer 1x door 1x shelf 1x marble countertop	1x drawer 1x door 1x shelf 1x marble countertop
Installation	floor-standing	floor-standing
01		

	MIRROR	MIRROR	MIRROR
			
	Express Delivery	Express Delivery	Express Delivery
Article number	8565 02 00	8565 01 00	8565 00 00
Dimensions (w x h x d)	985 x 740 x 37 mm	685 x 740 x 37 mm	557 x 740 x 37 mm
Scope of delivery	fastening set included	fastening set included	fastening set included

	VANITY UNIT WITH WASHBASIN	VANITY UNIT WITH WASHBASIN
		
	Express Delivery	Express Delivery
Article number	8980 63 XX	8980 A1 XX
Dimensions (w x h x d)	985 x 905 x 620 mm	985 x 905 x 620 mm
Version	washbasin on the middle	washbasin on the middle
Equipped with	1x drawer 2x door 1x shelf 1x marble countertop with ledge	1x drawer 2x door 1x shelf 1x marble countertop with ledge
Installation	floor-standing	floor-standing
Scope of delivery	Vanity unit, Built-in washbasin 7102 63, square handles to match ceramics, fastening set included	Vanity unit, Built-in washbasin 7102 A1, square handles to match ceramics, fastening set included
R1		

XX = Colour code to be indicated
R1 = White Alpin CeramicPlus

YY = Insert code for handle
01 = White Alpin



HOMMAGE

€ excl. VAT

Registered design

Goods in stock

Express Delivery These products are always in stock.

	SIDE CABINET	SIDE CABINET	
			
	Express Delivery	Express Delivery	
Article number	8964 20 YY	8964 21 YY	
Dimensions (w x h x d)	442 x 850 x 432 mm	442 x 850 x 432 mm	
Hinges	hinges on left	hinges on right	
Equipped with	1x drawer 1x door 1x shelf 1x marble countertop	1x drawer 1x door 1x shelf 1x marble countertop	
Installation	floor-standing	floor-standing	
01			
	MIRROR	MIRROR	MIRROR
			
	Express Delivery	Express Delivery	Express Delivery
Article number	8565 22 00	8565 21 00	8565 20 00
Dimensions (w x h x d)	985 x 740 x 37 mm	685 x 740 x 37 mm	557 x 740 x 37 mm
Scope of delivery	fastening set included	fastening set included	fastening set included

HOMMAGE

XX = Colour code to be indicated
R1 = White Alpin CeramicPlus

YY = Insert code for handle
01 = White Alpin

LEGATO

Bathroom furniture

- Mainstream segment
- Match washbasins in the collections Artis, Collaro, Finion, Loop & Friends, Memento 2.0, Memento, My Nature, Subway 2.0
- Designed to match all mirror collections
- Designed to match all mirror cabinet collections

PRO.VILLEROY-BOCH.COM/TECHNICALDRAWINGS



Front- / Body- / Countertop colours

LEGATO

									
DH = Glossy White	FP = Glossy Grey	MS = White Matt	PD = Black Matt Lacquer	VG = Truffle Grey	VK = Soft Grey	E8 = White Wood	PN = Elm Impresso	RH = Oak Kansas	RK = Stone Oak
									
VH = Arizona Oak	VJ = Nordic Oak								

LEGATO

Bathroom furniture



Updated drawer system

Before:

- Original Blum drawer frames in Light grey
- Interior of the drawers in Anthracite



New:

- Full-extension drawer with integrated slip-resistant base
- New generation of Blum drawer frames in Anthracite (optimised design)
- Interior of the drawers in Anthracite



It is not necessary to update drawers in the showroom.

The previous model numbers have been replaced by new model numbers.
Orders using the old model numbers are automatically converted into the new model number by the system.

























Example:

B124 00
→
B572 00
old model number
is transferred to
new model number

LEGATO

Combination options for Legato furniture with washbasins from different collections





























1 Legato vanity units, height 380 mm (with one drawer)

Width in mm		Artis				Collaro	
							
		4178 41	4179 43	4198 61	4172 58	4A18 40	4A21 38
450	washbasin on the middle 	B565 00/L0 (177)	B565 00/L0 (177)			B565 00/L0 (177)	B565 00/L0 (177)
600	washbasin on the middle 	B567 00/L0 (177)	B567 00/L0 (177)			B567 00/L0 (177)	B567 00/L0 (177)
800	washbasin on the middle 	B569 00/L0 (176)	B569 00/L0 (176)	B569 00/L0 (176)	B569 00/L0 (176)	B569 00/L0 (176)	B569 00/L0 (176)
1000	washbasin on the middle 	B571 00/L0 (175)	B571 00/L0 (175)	B571 00/L0 (175)	B571 00/L0 (175)	B571 00/L0 (175)	B571 00/L0 (175)
	washbasin on left 	B573 00/L0 (175)	B573 00/L0 (175)			B573 00/L0 (175)	B573 00/L0 (175)
	washbasin on right 	B575 00/L0 (176)	B575 00/L0 (176)			B575 00/L0 (176)	B575 00/L0 (176)
1200	washbasin on the middle 	B577 00/L0 (173)	B577 00/L0 (173)	B577 00/L0 (173)	B577 00/L0 (173)	B577 00/L0 (173)	B577 00/L0 (173)
	washbasin on left 	B579 00/L0 (173)	B579 00/L0 (173)			B579 00/L0 (173)	B579 00/L0 (173)
	washbasin on right 	B581 00/L0 (174)	B581 00/L0 (174)			B581 00/L0 (174)	B581 00/L0 (174)
	for 2 washbasins 	B583 00/L0 (172)	B583 00/L0 (172)			B583 00/L0 (172)	B583 00/L0 (172)
1400	washbasin on the middle 	B585 00/L0 (170)	B585 00/L0 (170)	B585 00/L0 (170)	B585 00/L0 (170)	B585 00/L0 (170)	B585 00/L0 (170)
	washbasin on left 	B587 00/L0 (171)	B587 00/L0 (171)	B587 00/L0 (171)	B587 00/L0 (171)	B587 00/L0 (171)	B587 00/L0 (171)
	washbasin on right 	B589 00/L0 (172)	B589 00/L0 (172)	B589 00/L0 (172)	B589 00/L0 (172)	B589 00/L0 (172)	B589 00/L0 (172)
	for 2 washbasins 	B591 00/L0 (170)	B591 00/L0 (170)			B591 00/L0 (170)	B591 00/L0 (170)
1600	washbasin on the middle 	B593 00/L0 (167)	B593 00/L0 (167)	B593 00/L0 (167)	B593 00/L0 (167)	B593 00/L0 (167)	B593 00/L0 (167)
	washbasin on left 	B595 00/L0 (168)	B595 00/L0 (168)	B595 00/L0 (168)	B595 00/L0 (168)	B595 00/L0 (168)	B595 00/L0 (168)
	washbasin on right 	B597 00/L0 (169)	B597 00/L0 (169)	B597 00/L0 (169)	B597 00/L0 (169)	B597 00/L0 (169)	B597 00/L0 (169)
	for 2 washbasins 	B599 00/L0 (166)	B599 00/L0 (166)	B599 00/L0 (166)	B599 00/L0 (166)	B599 00/L0 (166)	B599 00/L0 (166)

LEGATO

Combination options for Legato furniture with washbasins from different collections























1 Legato vanity units, height 380 mm (with one drawer)

Width in mm		Collaro				Finion					Loop & Friends
											
		4A19 56	4A20 56	4364 4L/4C	4139 DG/DC	4143 61	4142 61/64	4168 6L/6C	4168 8L/8C	4168 1H/1B/1L	5154 00/01
450	washbasin on the middle 										
600	washbasin on the middle 	B567 00/L0 (177)	B567 00/L0 (177)	B731 00/L0 (165)							
800	washbasin on the middle 	B569 00/L0 (176)	B569 00/L0 (176)	B733 00/L0 (165)		B737 00/L0 (194)	B753 00/L0 (198)	B678 00/L0 (190)			B569 00/L0 (176)
1000	washbasin on the middle 	B571 00/L0 (175)	B571 00/L0 (175)			B739 00/L0 (193)	B755 00/L0 (197)	B680 00/L0 (189)	B680 00/L0 (189)		B571 00/L0 (175)
	washbasin on left 	B573 00/L0 (175)	B573 00/L0 (175)								
	washbasin on right 	B575 00/L0 (176)	B575 00/L0 (176)								
1200	washbasin on the middle 	B577 00/L0 (173)	B577 00/L0 (173)			B741 00/L0 (193)	B757 00/L0 (197)	B682 00/L0 (188)	B682 00/L0 (188)	B682 00/L0 (188)	B577 00/L0 (173)
	washbasin on left 	B579 00/L0 (173)	B579 00/L0 (173)								
	washbasin on right 	B581 00/L0 (174)	B581 00/L0 (174)								
	for 2 washbasins 	B583 00/L0 (172)	B583 00/L0 (172)								
1400	washbasin on the middle 	B585 00/L0 (170)	B585 00/L0 (170)			B743 00/L0 (192)	B759 00/L0 (196)	B684 00/L0 (187)	B684 00/L0 (187)	B684 00/L0 (187)	B585 00/L0 (170)
	washbasin on left 	B587 00/L0 (171)	B587 00/L0 (171)								B587 00/L0 (171)
	washbasin on right 	B589 00/L0 (172)	B589 00/L0 (172)								B589 00/L0 (172)
	for 2 washbasins 	B591 00/L0 (170)	B591 00/L0 (170)								
1600	washbasin on the middle 	B593 00/L0 (167)	B593 00/L0 (167)		B735 00/L0 (164)	B745 00/L0 (191)	B761 00/L0 (195)	B686 00/L0 (185)	B686 00/L0 (185)	B686 00/L0 (185)	B593 00/L0 (167)
	washbasin on left 	B595 00/L0 (168)	B595 00/L0 (168)			B747 00/L0 (191)	B763 00/L0 (195)	B688 00/L0 (186)			B595 00/L0 (168)
	washbasin on right 	B597 00/L0 (169)	B597 00/L0 (169)			B749 00/L0 (192)	B765 00/L0 (196)	B690 00/L0 (186)			B597 00/L0 (169)
	for 2 washbasins 	B599 00/L0 (166)	B599 00/L0 (166)			B751 00/L0 (190)	B767 00/L0 (194)	B692 00/L0 (184)			B599 00/L0 (166)

LEGATO





















Combination options for Legato furniture with washbasins from different collections

1 Legato vanity units, height 380 mm (with one drawer)

Width in mm		Loop & Friends										
												
		5151 10/11	5151 00/01	5144 00/01	5148 00/01	4A45 00/01	4A46 00/01	4A47 00/01	4A48 00/01	4A49 00/01	4A50 00/01	
450	washbasin on the middle				B565 00/L0 (177)	B565 00/L0 (177)	B565 00/L0 (177)	B565 00/L0 (177)				
600	washbasin on the middle				B567 00/L0 (177)	B567 00/L0 (177)	B567 00/L0 (177)	B567 00/L0 (177)				
800	washbasin on the middle		B569 00/L0 (176)	B569 00/L0 (176)	B569 00/L0 (176)	B569 00/L0 (176)	B569 00/L0 (176)	B569 00/L0 (176)	B569 00/L0 (176)	B569 00/L0 (176)	B569 00/L0 (176)	B569 00/L0 (176)
1000	washbasin on the middle		B571 00/L0 (175)	B571 00/L0 (175)	B571 00/L0 (175)	B571 00/L0 (175)	B571 00/L0 (175)	B571 00/L0 (175)	B571 00/L0 (175)	B571 00/L0 (175)	B571 00/L0 (175)	B571 00/L0 (175)
	washbasin on left				B573 00/L0 (175)	B573 00/L0 (175)	B573 00/L0 (175)	B573 00/L0 (175)				
	washbasin on right				B575 00/L0 (176)	B575 00/L0 (176)	B575 00/L0 (176)	B575 00/L0 (176)				
1200	washbasin on the middle		B577 00/L0 (173)	B577 00/L0 (173)	B577 00/L0 (173)	B577 00/L0 (173)	B577 00/L0 (173)	B577 00/L0 (173)	B577 00/L0 (173)	B577 00/L0 (173)	B577 00/L0 (173)	B577 00/L0 (173)
	washbasin on left				B579 00/L0 (173)	B579 00/L0 (173)	B579 00/L0 (173)	B579 00/L0 (173)				
	washbasin on right				B581 00/L0 (174)	B581 00/L0 (174)	B581 00/L0 (174)	B581 00/L0 (174)				
	for 2 washbasins				B583 00/L0 (172)	B583 00/L0 (172)	B583 00/L0 (172)	B583 00/L0 (172)				
1400	washbasin on the middle		B585 00/L0 (170)	B585 00/L0 (170)	B585 00/L0 (170)	B585 00/L0 (170)	B585 00/L0 (170)	B585 00/L0 (170)	B585 00/L0 (170)	B585 00/L0 (170)	B585 00/L0 (170)	B585 00/L0 (170)
	washbasin on left		B587 00/L0 (171)	B587 00/L0 (171)	B587 00/L0 (171)	B587 00/L0 (171)	B587 00/L0 (171)	B587 00/L0 (171)	B587 00/L0 (171)	B587 00/L0 (171)	B587 00/L0 (171)	B587 00/L0 (171)
	washbasin on right		B589 00/L0 (172)	B589 00/L0 (172)	B589 00/L0 (172)	B589 00/L0 (172)	B589 00/L0 (172)	B589 00/L0 (172)	B589 00/L0 (172)	B589 00/L0 (172)	B589 00/L0 (172)	B589 00/L0 (172)
	for 2 washbasins			B591 00/L0 (170)	B591 00/L0 (170)	B591 00/L0 (170)	B591 00/L0 (170)	B591 00/L0 (170)	B591 00/L0 (170)		B591 00/L0 (170)	
1600	washbasin on the middle		B593 00/L0 (167)	B593 00/L0 (167)	B593 00/L0 (167)	B593 00/L0 (167)	B593 00/L0 (167)	B593 00/L0 (167)	B593 00/L0 (167)	B593 00/L0 (167)	B593 00/L0 (167)	B593 00/L0 (167)
	washbasin on left		B595 00/L0 (168)	B595 00/L0 (168)	B595 00/L0 (168)	B595 00/L0 (168)	B595 00/L0 (168)	B595 00/L0 (168)	B595 00/L0 (168)	B595 00/L0 (168)	B595 00/L0 (168)	B595 00/L0 (168)
	washbasin on right		B597 00/L0 (169)	B597 00/L0 (169)	B597 00/L0 (169)	B597 00/L0 (169)	B597 00/L0 (169)	B597 00/L0 (169)	B597 00/L0 (169)	B597 00/L0 (169)	B597 00/L0 (169)	B597 00/L0 (169)
	for 2 washbasins		B599 00/L0 (166)	B599 00/L0 (166)	B599 00/L0 (166)	B599 00/L0 (166)	B599 00/L0 (166)	B599 00/L0 (166)	B599 00/L0 (166)	B599 00/L0 (166)	B599 00/L0 (166)	B599 00/L0 (166)





















LEGATO

Combination options for Legato furniture with washbasins from different collections
1 Legato vanity units, height 380 mm (with one drawer)

Width in mm			Memento		Memento 2.0						
											
			5133 6L	5133 5L	4A07 60/61	4A22 5G/5L/5F	4A22 6G/6L/6F	4A22 8G/8L/8F	4A22 1G/1H/1F/1K	4A22 CL/CH/CF/CG	
600	washbasin on the middle										
800	washbasin on the middle		B601 00/L0 (184)	B601 00/L0 (184)	B753 00/L0 (198)	B601 00/L0 (184)	B601 00/L0 (184)				
1000	washbasin on the middle		B603 00/L0 (182)	B603 00/L0 (182)	B755 00/L0 (197)	B603 00/L0 (182)	B603 00/L0 (182)	B603 00/L0 (182)			
	washbasin on left			B605 00/L0 (183)		B605 00/L0 (183)					
	washbasin on right			B607 00/L0 (183)		B607 00/L0 (183)					
1200	washbasin on the middle				B757 00/L0 (197)			B609 00/L0 (182)	B609 00/L0 (182)		
	washbasin on left										
	washbasin on right										
	for 2 washbasins										
1400	washbasin on the middle				B759 00/L0 (196)			B611 00/L0 (180)	B611 00/L0 (180)	B611 00/L0 (180)	
	washbasin on left			B613 00/L0 (181)		B613 00/L0 (181)					
	washbasin on right			B615 00/L0 (181)		B615 00/L0 (181)					
	for 2 washbasins			B668 00/L0 (180)		B668 00/L0 (180)					
1600	washbasin on the middle				B761 00/L0 (195)			B670 00/L0 (178)	B670 00/L0 (178)	B670 00/L0 (178)	
	washbasin on left		B672 00/L0 (179)	B672 00/L0 (179)	B763 00/L0 (195)	B672 00/L0 (179)	B672 00/L0 (179)				
	washbasin on right		B674 00/L0 (179)	B674 00/L0 (179)	B765 00/L0 (196)	B674 00/L0 (179)	B674 00/L0 (179)				
	for 2 washbasins		B676 00/L0 (178)	B676 00/L0 (178)	B767 00/L0 (194)	B676 00/L0 (178)	B676 00/L0 (178)				

LEGATO

Combination options for Legato furniture with washbasins from different collections
 1 Legato vanity units, height 380 mm (with one drawer)

























Width in mm		My Nature		Subway 2.0				
								
		4110 80	4110 60	7175 8G	7175 1G	7113 KG	7113 6G	
600	washbasin on the middle							
800	washbasin on the middle			B569 00/L0 (176)			B678 00/L0 (190)	B678 00/L0 (190)
1000	washbasin on the middle		B571 00/L0 (175)	B571 00/L0 (175)	B694 00/L0 (189)		B680 00/L0 (189)	B680 00/L0 (189)
	washbasin on left							
	washbasin on right							
1200	washbasin on the middle		B577 00/L0 (173)	B577 00/L0 (173)	B696 00/L0 (188)	B696 00/L0 (188)	B682 00/L0 (188)	B682 00/L0 (188)
	washbasin on left			B579 00/L0 (173)				
	washbasin on right			B581 00/L0 (174)				
	for 2 washbasins							
1400	washbasin on the middle		B585 00/L0 (170)	B585 00/L0 (170)	B698 00/L0 (187)	B698 00/L0 (187)	B684 00/L0 (187)	B684 00/L0 (187)
	washbasin on left			B587 00/L0 (171)				
	washbasin on right			B589 00/L0 (172)				
	for 2 washbasins							
1600	washbasin on the middle		B593 00/L0 (167)	B593 00/L0 (167)	B700 00/L0 (185)	B700 00/L0 (185)	B686 00/L0 (185)	B686 00/L0 (185)
	washbasin on left		B595 00/L0 (168)	B595 00/L0 (168)			B688 00/L0 (186)	B688 00/L0 (186)
	washbasin on right		B597 00/L0 (169)	B597 00/L0 (169)			B690 00/L0 (186)	B690 00/L0 (186)
	for 2 washbasins			B599 00/L0 (166)			B692 00/L0 (184)	B692 00/L0 (184)

LEGATO

LEGATO

Combination options for Legato furniture with washbasins from different collections





























2 Legato vanity units, height 550 mm (with two drawers)

Width in mm			Artis				Collaro	
								
			4178 41	4179 43	4198 61	4172 58	4A18 40	4A21 38
450	washbasin on the middle		B566 00/L0 (177)	B566 00/L0 (177)			B566 00/L0 (177)	B566 00/L0 (177)
600	washbasin on the middle		B568 00/L0 (177)	B568 00/L0 (177)			B568 00/L0 (177)	B568 00/L0 (177)
800	washbasin on the middle		B570 00/L0 (176)	B570 00/L0 (176)	B570 00/L0 (176)	B570 00/L0 (176)	B570 00/L0 (176)	B570 00/L0 (176)
1000	washbasin on the middle		B572 00/L0 (175)	B572 00/L0 (175)	B572 00/L0 (175)	B572 00/L0 (175)	B572 00/L0 (175)	B572 00/L0 (175)
	washbasin on left		B574 00/L0 (175)	B574 00/L0 (175)			B574 00/L0 (175)	B574 00/L0 (175)
	washbasin on right		B576 00/L0 (176)	B576 00/L0 (176)			B576 00/L0 (176)	B576 00/L0 (176)
1200	washbasin on the middle		B578 00/L0 (173)	B578 00/L0 (173)	B578 00/L0 (173)	B578 00/L0 (173)	B578 00/L0 (173)	B578 00/L0 (173)
	washbasin on left		B580 00/L0 (173)	B580 00/L0 (173)			B580 00/L0 (173)	B580 00/L0 (173)
	washbasin on right		B582 00/L0 (174)	B582 00/L0 (174)			B582 00/L0 (174)	B582 00/L0 (174)
	for 2 washbasins		B584 00/L0 (172)	B584 00/L0 (172)			B584 00/L0 (172)	B584 00/L0 (172)
1400	washbasin on the middle		B586 00/L0 (170)	B586 00/L0 (170)	B586 00/L0 (170)	B586 00/L0 (170)	B586 00/L0 (170)	B586 00/L0 (170)
	washbasin on left		B588 00/L0 (171)	B588 00/L0 (171)	B588 00/L0 (171)	B588 00/L0 (171)	B588 00/L0 (171)	B588 00/L0 (171)
	washbasin on right		B590 00/L0 (172)	B590 00/L0 (172)	B590 00/L0 (172)	B590 00/L0 (172)	B590 00/L0 (172)	B590 00/L0 (172)
	for 2 washbasins		B592 00/L0 (170)	B592 00/L0 (170)			B592 00/L0 (170)	B592 00/L0 (170)
1600	washbasin on the middle		B594 00/L0 (167)	B594 00/L0 (167)	B594 00/L0 (167)	B594 00/L0 (167)	B594 00/L0 (167)	B594 00/L0 (167)
	washbasin on left		B596 00/L0 (168)	B596 00/L0 (168)	B596 00/L0 (168)	B596 00/L0 (168)	B596 00/L0 (168)	B596 00/L0 (168)
	washbasin on right		B598 00/L0 (169)	B598 00/L0 (169)	B598 00/L0 (169)	B598 00/L0 (169)	B598 00/L0 (169)	B598 00/L0 (169)
	for 2 washbasins		B600 00/L0 (166)	B600 00/L0 (166)	B600 00/L0 (166)	B600 00/L0 (166)	B600 00/L0 (166)	B600 00/L0 (166)

LEGATO

Combination options for Legato furniture with washbasins from different collections

























2 Legato vanity units, height 550 mm (with two drawers)

Width in mm		Collaro				Finion					Loop & Friends	
												
		4A19 56	4A20 56	4364 4L/4C	4139 DG/DC	4143 61	4142 61/64	4168 6L/6C	4168 8L/8C	4168 1H/1B/1L	5154 00/01	
450	washbasin on the middle 											
600	washbasin on the middle 	B568 00/L0 (177)	B568 00/L0 (177)	B732 00/L0 (165)								
800	washbasin on the middle 	B570 00/L0 (176)	B570 00/L0 (176)	B734 00/L0 (165)		B738 00/L0 (194)	B754 00/L0 (198)	B679 00/L0 (190)			B570 00/L0 (176)	
1000	washbasin on the middle 	B572 00/L0 (175)	B572 00/L0 (175)			B740 00/L0 (193)	B756 00/L0 (197)	B681 00/L0 (189)	B681 00/L0 (189)		B572 00/L0 (175)	
	washbasin on left 	B574 00/L0 (175)	B574 00/L0 (175)									
	washbasin on right 	B576 00/L0 (176)	B576 00/L0 (176)									
1200	washbasin on the middle 	B578 00/L0 (173)	B578 00/L0 (173)			B742 00/L0 (193)	B758 00/L0 (197)	B683 00/L0 (188)	B683 00/L0 (188)	B683 00/L0 (188)	B578 00/L0 (173)	
	washbasin on left 	B580 00/L0 (173)	B580 00/L0 (173)									
	washbasin on right 	B582 00/L0 (174)	B582 00/L0 (174)									
	for 2 washbasins 	B584 00/L0 (172)	B584 00/L0 (172)									
1400	washbasin on the middle 	B586 00/L0 (170)	B586 00/L0 (170)			B744 00/L0 (192)	B760 00/L0 (196)	B685 00/L0 (187)	B685 00/L0 (187)	B685 00/L0 (187)	B586 00/L0 (170)	
	washbasin on left 	B588 00/L0 (171)	B588 00/L0 (171)								B588 00/L0 (171)	
	washbasin on right 	B590 00/L0 (172)	B590 00/L0 (172)								B590 00/L0 (172)	
	for 2 washbasins 	B592 00/L0 (170)	B592 00/L0 (170)									
1600	washbasin on the middle 	B594 00/L0 (167)	B594 00/L0 (167)			B736 00/L0 (164)	B746 00/L0 (191)	B762 00/L0 (195)	B687 00/L0 (185)	B687 00/L0 (185)	B687 00/L0 (185)	B594 00/L0 (167)
	washbasin on left 	B596 00/L0 (168)	B596 00/L0 (168)				B748 00/L0 (191)	B764 00/L0 (195)	B689 00/L0 (186)			B596 00/L0 (168)
	washbasin on right 	B598 00/L0 (169)	B598 00/L0 (169)				B750 00/L0 (192)	B766 00/L0 (196)	B691 00/L0 (186)			B598 00/L0 (169)
	for 2 washbasins 	B600 00/L0 (166)	B600 00/L0 (166)				B752 00/L0 (190)	B768 00/L0 (194)	B693 00/L0 (184)			B600 00/L0 (166)

LEGATO

Combination options for Legato furniture with washbasins from different collections













2 Legato vanity units, height 550 mm (with two drawers)

Width in mm	Loop & Friends											
												
			5151 10/11	5151 00/01	5144 00/01	5148 00/01	4A45 00/01	4A46 00/01	4A47 00/01	4A48 00/01	4A49 00/01	4A50 00/01
450	washbasin on the middle				B566 00/L0 (177)	B566 00/L0 (177)	B566 00/L0 (177)	B566 00/L0 (177)				
600	washbasin on the middle				B568 00/L0 (177)	B568 00/L0 (177)	B568 00/L0 (177)	B568 00/L0 (177)				
800	washbasin on the middle		B570 00/L0 (176)	B570 00/L0 (176)	B570 00/L0 (176)	B570 00/L0 (176)	B570 00/L0 (176)	B570 00/L0 (176)	B570 00/L0 (176)	B570 00/L0 (176)	B570 00/L0 (176)	B570 00/L0 (176)
1000	washbasin on the middle		B572 00/L0 (175)	B572 00/L0 (175)	B572 00/L0 (175)	B572 00/L0 (175)	B572 00/L0 (175)	B572 00/L0 (175)	B572 00/L0 (175)	B572 00/L0 (175)	B572 00/L0 (175)	B572 00/L0 (175)
	washbasin on left				B574 00/L0 (175)	B574 00/L0 (175)	B574 00/L0 (175)	B574 00/L0 (175)				
	washbasin on right				B576 00/L0 (176)	B576 00/L0 (176)	B576 00/L0 (176)	B576 00/L0 (176)				
1200	washbasin on the middle		B578 00/L0 (173)	B578 00/L0 (173)	B578 00/L0 (173)	B578 00/L0 (173)	B578 00/L0 (173)	B578 00/L0 (173)	B578 00/L0 (173)	B578 00/L0 (173)	B578 00/L0 (173)	B578 00/L0 (173)
	washbasin on left				B580 00/L0 (173)	B580 00/L0 (173)	B580 00/L0 (173)	B580 00/L0 (173)				
	washbasin on right				B582 00/L0 (174)	B582 00/L0 (174)	B582 00/L0 (174)	B582 00/L0 (174)				
	for 2 washbasins				B584 00/L0 (172)	B584 00/L0 (172)	B584 00/L0 (172)	B584 00/L0 (172)				
1400	washbasin on the middle		B586 00/L0 (170)	B586 00/L0 (170)	B586 00/L0 (170)	B586 00/L0 (170)	B586 00/L0 (170)	B586 00/L0 (170)	B586 00/L0 (170)	B586 00/L0 (170)	B586 00/L0 (170)	B586 00/L0 (170)
	washbasin on left		B588 00/L0 (171)	B588 00/L0 (171)	B588 00/L0 (171)	B588 00/L0 (171)	B588 00/L0 (171)	B588 00/L0 (171)	B588 00/L0 (171)	B588 00/L0 (171)	B588 00/L0 (171)	B588 00/L0 (171)
	washbasin on right		B590 00/L0 (172)	B590 00/L0 (172)	B590 00/L0 (172)	B590 00/L0 (172)	B590 00/L0 (172)	B590 00/L0 (172)	B590 00/L0 (172)	B590 00/L0 (172)	B590 00/L0 (172)	B590 00/L0 (172)
	for 2 washbasins			B592 00/L0 (170)	B592 00/L0 (170)	B592 00/L0 (170)	B592 00/L0 (170)	B592 00/L0 (170)	B592 00/L0 (170)		B592 00/L0 (170)	
1600	washbasin on the middle		B594 00/L0 (167)	B594 00/L0 (167)	B594 00/L0 (167)	B594 00/L0 (167)	B594 00/L0 (167)	B594 00/L0 (167)	B594 00/L0 (167)	B594 00/L0 (167)	B594 00/L0 (167)	B594 00/L0 (167)
	washbasin on left		B596 00/L0 (168)	B596 00/L0 (168)	B596 00/L0 (168)	B596 00/L0 (168)	B596 00/L0 (168)	B596 00/L0 (168)	B596 00/L0 (168)	B596 00/L0 (168)	B596 00/L0 (168)	B596 00/L0 (168)
	washbasin on right		B598 00/L0 (169)	B598 00/L0 (169)	B598 00/L0 (169)	B598 00/L0 (169)	B598 00/L0 (169)	B598 00/L0 (169)	B598 00/L0 (169)	B598 00/L0 (169)	B598 00/L0 (169)	B598 00/L0 (169)
	for 2 washbasins		B600 00/L0 (166)	B600 00/L0 (166)	B600 00/L0 (166)	B600 00/L0 (166)	B600 00/L0 (166)	B600 00/L0 (166)	B600 00/L0 (166)	B600 00/L0 (166)	B600 00/L0 (166)	B600 00/L0 (166)

LEGATO























Combination options for Legato furniture with washbasins from different collections

2 Legato vanity units, height 550 mm (with two drawers)

Width in mm			Memento		Memento 2.0							
												
			5133 6L	5133 5L	4A07 60/61	4A22 5G/5L/5F	4A22 6G/6L/6F	4A22 8G/8L/8F	4A22 1G/1H/1F/1K	4A22 CL/CH/CF/CG		
600	washbasin on the middle											
800	washbasin on the middle		B602 00/L0 (184)	B602 00/L0 (184)	B754 00/L0 (198)	B602 00/L0 (184)	B602 00/L0 (184)					
1000	washbasin on the middle		B604 00/L0 (182)	B604 00/L0 (182)	B756 00/L0 (197)	B604 00/L0 (182)	B604 00/L0 (182)	B604 00/L0 (182)				
	washbasin on left			B606 00/L0 (183)		B606 00/L0 (183)						
	washbasin on right			B608 00/L0 (183)		B608 00/L0 (183)						
1200	washbasin on the middle				B758 00/L0 (197)			B610 00/L0 (182)	B610 00/L0 (182)			
	washbasin on left											
	washbasin on right											
	for 2 washbasins											
1400	washbasin on the middle				B760 00/L0 (196)			B612 00/L0 (180)	B612 00/L0 (180)	B612 00/L0 (180)		
	washbasin on left			B614 00/L0 (181)		B614 00/L0 (181)						
	washbasin on right			B616 00/L0 (181)		B616 00/L0 (181)						
	for 2 washbasins			B669 00/L0 (180)		B669 00/L0 (180)						
1600	washbasin on the middle				B762 00/L0 (195)			B671 00/L0 (178)	B671 00/L0 (178)	B671 00/L0 (178)		
	washbasin on left		B673 00/L0 (179)	B673 00/L0 (179)	B764 00/L0 (195)	B673 00/L0 (179)	B673 00/L0 (179)					
	washbasin on right		B675 00/L0 (179)	B675 00/L0 (179)	B766 00/L0 (196)	B675 00/L0 (179)	B675 00/L0 (179)					
	for 2 washbasins		B677 00/L0 (178)	B677 00/L0 (178)	B768 00/L0 (194)	B677 00/L0 (178)	B677 00/L0 (178)					

LEGATO

Combination options for Legato furniture with washbasins from different collections
 2 Legato vanity units, height 550 mm (with two drawers)

Width in mm			My Nature		Subway 2.0				
									
			4110 60	4110 80	7175 1G	7175 8G	7113 6G	7113 KG	
600	washbasin on the middle								
800	washbasin on the middle		B570 00/L0 (176)				B679 00/L0 (190)	B679 00/L0 (190)	
1000	washbasin on the middle		B572 00/L0 (175)	B572 00/L0 (175)		B695 00/L0 (189)	B681 00/L0 (189)	B681 00/L0 (189)	
	washbasin on left								
	washbasin on right								
1200	washbasin on the middle		B578 00/L0 (173)	B578 00/L0 (173)	B697 00/L0 (188)	B697 00/L0 (188)	B683 00/L0 (188)	B683 00/L0 (188)	
	washbasin on left		B580 00/L0 (173)						
	washbasin on right		B582 00/L0 (174)						
	for 2 washbasins								
1400	washbasin on the middle		B586 00/L0 (170)	B586 00/L0 (170)	B699 00/L0 (187)	B699 00/L0 (187)	B685 00/L0 (187)	B685 00/L0 (187)	
	washbasin on left		B588 00/L0 (171)						
	washbasin on right		B590 00/L0 (172)						
	for 2 washbasins								
1600	washbasin on the middle		B594 00/L0 (167)	B594 00/L0 (167)	B701 00/L0 (185)	B701 00/L0 (185)	B687 00/L0 (185)	B687 00/L0 (185)	
	washbasin on left		B596 00/L0 (168)	B596 00/L0 (168)			B689 00/L0 (186)	B689 00/L0 (186)	
	washbasin on right		B598 00/L0 (169)	B598 00/L0 (169)			B691 00/L0 (186)	B691 00/L0 (186)	
	for 2 washbasins		B600 00/L0 (166)				B693 00/L0 (184)	B693 00/L0 (184)	

LEGATO

€ excl. VAT





Registered design

Produced to order (Please note that it is not always possible to cancel or change orders!), The washbasins are to be ordered separately.

- Front:**
 MDF with acrylic film in DH, FP (19 mm)
 direct-laminated chipboard in E8, MS, PN, RH, RK, VG, VH, VJ, VK (19 mm)
 painted MDF in PD (19 mm)
 horizontal grain in E8, PN, RH, RK, VH, VJ
 matching interior colour for DH, FP
 interior colour to match décor for E8, MS, RH, RK, VG, VH, VJ, VK
 interior colour Anthracite for PD
- Body:**
 MDF with acrylic film in DH, FP (19 mm)
 direct-laminated chipboard in E8, MS, PN, RH, RK, VG, VH, VJ, VK (19 mm)
 painted MDF in PD (19 mm)
 horizontal grain in E8, PN, RH, RK, VH, VJ
 matching interior colour for DH, FP
 interior colour to match décor for E8, MS, RH, RK, VG, VH, VJ, VK
 interior colour Anthracite for PD
- Washbasin countertop:**
 laminated chipboard, painted in DH, FP, PD (40 mm)
 laminated chipboard in E8, MS, PN, RH, RK, VG, VH, VJ, VK (40 mm)
- Bevelled edge on washbasin countertop:**
 mineral material painted in DH, FP, PD
 Mineral material in white (E8, MS), beige (PN, RH, VJ, VK), grey (RK, VH) and creme (VG)
- Drawers:**
 Slip-resistant base
 SoftClosing feature
- Doors:**
 SoftClosing feature
- Interior compartments :**
 adjustable glass partitions (8 mm)
 accessory boxes made of grey translucent plastic
- Lighting:**
 integrated LED lighting
 3 dimmer settings
 freely-adjustable light colour from DaylightWhite (6500 kelvin) to WarmWhite (2700 kelvin)
 sensor switch
 auto-on function – when switching on, the light intensity is always 100%, the colour temperature remains pre-set
 loose mains connection

Please note:

For further information such as tap fitting positions, installation and fastening dimensions etc. please see the technical drawings. The washbasin clippings shown are representative of all washbasin combination options.

	ACCESSORIES PACKAGE 1			
Equipped with	1x wide glass drawer divider 2x narrow glass drawer divider 1x accessory box L			
				
Article number	B735 00 XX	B735 L0 XX	B736 00 XX	B736 L0 XX
Dimensions (w x h x d)	1600 x 380 x 500 mm	1600 x 380 x 500 mm	1600 x 550 x 500 mm	1600 x 550 x 500 mm
Version	washbasin on the middle	washbasin on the middle	washbasin on the middle	washbasin on the middle
For combination with	Finion 4139 DC/DG	Finion 4139 DC/DG	Finion 4139 DC/DG	Finion 4139 DC/DG
Lighting	-	LED lighting Lighting 1x LED / 34,1 W	-	LED lighting Lighting 1x LED / 34,1 W
Equipped with	2x Accessories package 1 2x pull-out compartment with non-slip mat	2x Accessories package 1 2x pull-out compartment with non-slip mat	2x Accessories package 1 4x pull-out compartment with non-slip mat	2x Accessories package 1 4x pull-out compartment with non-slip mat
Note on standard	-	IP 44	-	IP 44
Installation	wall-mounted	wall-mounted	wall-mounted	wall-mounted
Scope of delivery	fastening set included	fastening set included	fastening set included	fastening set included
DH, E8, FP, MS, PN, RH, RK, VG, VH, VJ, VK				
PD				









XX = Insert front and body colour
 DH = Glossy White, FP = Glossy Grey, MS = White Matt, PD = Black Matt
 Lacquer, VG = Truffle Grey, VK = Soft Grey, E8 = White Wood, PN = Elm
 Impreso, RH = Oak Kansas, RK = Stone Oak, VH = Arizona Oak, VJ =
 Nordic Oak

LEGATO

€ excl. VAT

Registered design

Produced to order (Please note that it is not always possible to cancel or change orders!), The washbasins are to be ordered separately.

	VANITY UNIT	VANITY UNIT	VANITY UNIT	VANITY UNIT
				
Article number	B733 00 XX	B733 L0 XX	B734 00 XX	B734 L0 XX
Dimensions (w x h x d)	800 x 380 x 500 mm	800 x 380 x 500 mm	800 x 550 x 500 mm	800 x 550 x 500 mm
Version	washbasin on the middle	washbasin on the middle	washbasin on the middle	washbasin on the middle
For combination with	Finion 4364 4C/4L	Finion 4364 4C/4L	Finion 4364 4C/4L	Finion 4364 4C/4L
Lighting	-	LED lighting Lighting 1x LED / 21,6 W	-	LED lighting Lighting 1x LED / 21,6 W
Equipped with	1x Accessories package 1 1x pull-out compartment with non-slip mat	1x Accessories package 1 1x pull-out compartment with non-slip mat	1x Accessories package 1 2x pull-out compartment with non-slip mat	1x Accessories package 1 2x pull-out compartment with non-slip mat
Note on standard	-	IP 44	-	IP 44
Installation	wall-mounted	wall-mounted	wall-mounted	wall-mounted
Scope of delivery	fastening set included	fastening set included	fastening set included	fastening set included
DH, E8, FP, MS, PN, RH, RK, VG, VH, VJ, VK				
PD				
	VANITY UNIT	VANITY UNIT	VANITY UNIT	VANITY UNIT
				
Article number	B731 00 XX	B731 L0 XX	B732 00 XX	B732 L0 XX
Dimensions (w x h x d)	600 x 380 x 500 mm	600 x 380 x 500 mm	600 x 550 x 500 mm	600 x 550 x 500 mm
Version	washbasin on the middle	washbasin on the middle	washbasin on the middle	washbasin on the middle
For combination with	Finion 4364 4C/4L	Finion 4364 4C/4L	Finion 4364 4C/4L	Finion 4364 4C/4L
Lighting	-	LED lighting Lighting 1x LED / 18,5 W	-	LED lighting Lighting 1x LED / 18,5 W
Equipped with	1x Accessories package 1 1x pull-out compartment with non-slip mat	1x Accessories package 1 1x pull-out compartment with non-slip mat	1x Accessories package 1 2x pull-out compartment with non-slip mat	1x Accessories package 1 2x pull-out compartment with non-slip mat
Note on standard	-	IP 44	-	IP 44
Installation	wall-mounted	wall-mounted	wall-mounted	wall-mounted
Scope of delivery	fastening set included	fastening set included	fastening set included	fastening set included
DH, E8, FP, MS, PN, RH, RK, VG, VH, VJ, VK				
PD				

LEGATO





XX = Insert front and body colour
 DH = Glossy White, FP = Glossy Grey, MS = White Matt, PD = Black Matt
 Lacquer, VG = Truffle Grey, VK = Soft Grey, E8 = White Wood, PN = Elm
 Impresso, RH = Oak Kansas, RK = Stone Oak, VH = Arizona Oak, VJ =
 Nordic Oak

LEGATO

€ excl. VAT

Registered design

Produced to order (Please note that it is not always possible to cancel or change orders!), The washbasins are to be ordered separately.

	VANITY UNIT	VANITY UNIT	VANITY UNIT	VANITY UNIT
				
Article number	B599 00 XX	B599 L0 XX	B600 00 XX	B600 L0 XX
Dimensions (w x h x d)	1600 x 380 x 500 mm	1600 x 380 x 500 mm	1600 x 550 x 500 mm	1600 x 550 x 500 mm
Version	for 2 washbasins	for 2 washbasins	for 2 washbasins	for 2 washbasins
For combination with	Loop & Friends 5144 00/01, 5148 00/01, 5151 00/01/10/11, 5154 00/01 My Nature 4110 60 Artis 4179 43, 4198 61, 4172 58, 4178 41 Collaro 4A18 40, 4A21 38, 4A19 56, 4A20 56 Loop&Friends 4A45 00/01, 4A46 00/01, 4A47 00/01, 4A48 00/01, 4A49 00/01, 4A50 00/01	Loop & Friends 5144 00/01, 5148 00/01, 5151 00/01/10/11, 5154 00/01 My Nature 4110 60 Artis 4179 43, 4198 61, 4172 58, 4178 41 Collaro 4A18 40, 4A21 38, 4A19 56, 4A20 56 Loop&Friends 4A45 00/01, 4A46 00/01, 4A47 00/01, 4A48 00/01, 4A49 00/01, 4A50 00/01	Loop & Friends 5144 00/01, 5148 00/01, 5151 00/01/10/11, 5154 00/01 My Nature 4110 60 Artis 4179 43, 4198 61, 4172 58, 4178 41 Collaro 4A18 40, 4A21 38, 4A19 56, 4A20 56 Loop&Friends 4A45 00/01, 4A46 00/01, 4A47 00/01, 4A48 00/01, 4A49 00/01, 4A50 00/01	Loop & Friends 5144 00/01, 5148 00/01, 5151 00/01/10/11, 5154 00/01 My Nature 4110 60 Artis 4179 43, 4198 61, 4172 58, 4178 41 Collaro 4A18 40, 4A21 38, 4A19 56, 4A20 56 Loop&Friends 4A45 00/01, 4A46 00/01, 4A47 00/01, 4A48 00/01, 4A49 00/01, 4A50 00/01
Lighting	-	LED lighting Lighting 1x LED / 34,1 W	-	LED lighting Lighting 1x LED / 34,1 W
Equipped with	2x Accessories package 1 2x pull-out compartment with non-slip mat	2x Accessories package 1 2x pull-out compartment with non-slip mat	2x Accessories package 1 4x pull-out compartment with non-slip mat	2x Accessories package 1 4x pull-out compartment with non-slip mat
Note on standard	-	IP 44	-	IP 44
Installation	wall-mounted	wall-mounted	wall-mounted	wall-mounted
Scope of delivery	fastening set included	fastening set included	fastening set included	fastening set included
DH, E8, FP, MS, PN, RH, RK, VG, VH, VJ, VK				
PD				





XX = Insert front and body colour
 DH = Glossy White, FP = Glossy Grey, MS = White Matt, PD = Black Matt
 Lacquer, VG = Truffle Grey, VK = Soft Grey, E8 = White Wood, PN = Elm
 Impreso, RH = Oak Kansas, RK = Stone Oak, VH = Arizona Oak, VJ =
 Nordic Oak

LEGATO

€ excl. VAT

Registered design

Produced to order (Please note that it is not always possible to cancel or change orders!), The washbasins are to be ordered separately.

	VANITY UNIT	VANITY UNIT	VANITY UNIT	VANITY UNIT
				
Article number	B593 00 XX	B593 L0 XX	B594 00 XX	B594 L0 XX
Dimensions (w x h x d)	1600 x 380 x 500 mm	1600 x 380 x 500 mm	1600 x 550 x 500 mm	1600 x 550 x 500 mm
Version	washbasin on the middle	washbasin on the middle	washbasin on the middle	washbasin on the middle
For combination with	Loop & Friends 5144 00/01, 5148 00/01, 5151 00/01/10/11, 5154 00/01 My Nature 4110 80/60 Artis 4179 43, 4198 61, 4172 58, 4178 41 Collaro 4A18 40, 4A21 38, 4A19 56, 4A20 56 Loop&Friends 4A45 00/01, 4A46 00/01, 4A47 00/01, 4A48 00/01, 4A49 00/01, 4A50 00/01	Loop & Friends 5144 00/01, 5148 00/01, 5151 00/01/10/11, 5154 00/01 My Nature 4110 80/60 Artis 4179 43, 4198 61, 4172 58, 4178 41 Collaro 4A18 40, 4A21 38, 4A19 56, 4A20 56 Loop&Friends 4A45 00/01, 4A46 00/01, 4A47 00/01, 4A48 00/01, 4A49 00/01, 4A50 00/01	Loop & Friends 5144 00/01, 5148 00/01, 5151 00/01/10/11, 5154 00/01 My Nature 4110 80/60 Artis 4179 43, 4198 61, 4172 58, 4178 41 Collaro 4A18 40, 4A21 38, 4A19 56, 4A20 56 Loop&Friends 4A45 00/01, 4A46 00/01, 4A47 00/01, 4A48 00/01, 4A49 00/01, 4A50 00/01	Loop & Friends 5144 00/01, 5148 00/01, 5151 00/01/10/11, 5154 00/01 My Nature 4110 80/60 Artis 4179 43, 4198 61, 4172 58, 4178 41 Collaro 4A18 40, 4A21 38, 4A19 56, 4A20 56 Loop&Friends 4A45 00/01, 4A46 00/01, 4A47 00/01, 4A48 00/01, 4A49 00/01, 4A50 00/01
Lighting	-	LED lighting Lighting 1x LED / 34,1 W	-	LED lighting Lighting 1x LED / 34,1 W
Equipped with	2x Accessories package 1 3x pull-out compartment with non-slip mat	2x Accessories package 1 3x pull-out compartment with non-slip mat	2x Accessories package 1 5x pull-out compartment with non-slip mat	2x Accessories package 1 5x pull-out compartment with non-slip mat
Note on standard	-	IP 44	-	IP 44
Installation	wall-mounted	wall-mounted	wall-mounted	wall-mounted
Scope of delivery	fastening set included	fastening set included	fastening set included	fastening set included
DH, E8, FP, MS, PN, RH, RK, VG, VH, VJ, VK				
PD				

XX = Insert front and body colour



 DH = Glossy White, FP = Glossy Grey, MS = White Matt, PD = Black Matt
 Lacquer, VG = Truffle Grey, VK = Soft Grey, E8 = White Wood, PN = Elm
 Impreso, RH = Oak Kansas, RK = Stone Oak, VH = Arizona Oak, VJ =
 Nordic Oak

LEGATO

€ excl. VAT

Registered design

Produced to order (Please note that it is not always possible to cancel or change orders!), The washbasins are to be ordered separately.

	VANITY UNIT	VANITY UNIT	VANITY UNIT	VANITY UNIT
				
Article number	B595 00 XX	B595 L0 XX	B596 00 XX	B596 L0 XX
Dimensions (w x h x d)	1600 x 380 x 500 mm	1600 x 380 x 500 mm	1600 x 550 x 500 mm	1600 x 550 x 500 mm
Version	washbasin on left	washbasin on left	washbasin on left	washbasin on left
For combination with	Loop & Friends 5144 00/01, 5148 00/01, 5151 00/01/10/11, 5154 00/01 My Nature 4110 80/60 Artis 4179 43, 4198 61, 4172 58, 4178 41 Collaro 4A18 40, 4A21 38, 4A19 56, 4A20 56 Loop&Friends 4A45 00/01, 4A46 00/01, 4A47 00/01, 4A48 00/01, 4A49 00/01, 4A50 00/01	Loop & Friends 5144 00/01, 5148 00/01, 5151 00/01/10/11, 5154 00/01 My Nature 4110 80/60 Artis 4179 43, 4198 61, 4172 58, 4178 41 Collaro 4A18 40, 4A21 38, 4A19 56, 4A20 56 Loop&Friends 4A45 00/01, 4A46 00/01, 4A47 00/01, 4A48 00/01, 4A49 00/01, 4A50 00/01	Loop & Friends 5144 00/01, 5148 00/01, 5151 00/01/10/11, 5154 00/01 My Nature 4110 80/60 Artis 4179 43, 4198 61, 4172 58, 4178 41 Collaro 4A18 40, 4A21 38, 4A19 56, 4A20 56 Loop&Friends 4A45 00/01, 4A46 00/01, 4A47 00/01, 4A48 00/01, 4A49 00/01, 4A50 00/01	Loop & Friends 5144 00/01, 5148 00/01, 5151 00/01/10/11, 5154 00/01 My Nature 4110 80/60 Artis 4179 43, 4198 61, 4172 58, 4178 41 Collaro 4A18 40, 4A21 38, 4A19 56, 4A20 56 Loop&Friends 4A45 00/01, 4A46 00/01, 4A47 00/01, 4A48 00/01, 4A49 00/01, 4A50 00/01
Lighting	-	LED lighting Lighting 1x LED / 34,1 W	-	LED lighting Lighting 1x LED / 34,1 W
Equipped with	2x Accessories package 1 2x pull-out compartment with non-slip mat	2x Accessories package 1 2x pull-out compartment with non-slip mat	2x Accessories package 1 4x pull-out compartment with non-slip mat	2x Accessories package 1 4x pull-out compartment with non-slip mat
Note on standard	-	IP 44	-	IP 44
Installation	wall-mounted	wall-mounted	wall-mounted	wall-mounted
Scope of delivery	fastening set included	fastening set included	fastening set included	fastening set included
DH, E8, FP, MS, PN, RH, RK, VG, VH, VJ, VK				
PD				





XX = Insert front and body colour
 DH = Glossy White, FP = Glossy Grey, MS = White Matt, PD = Black Matt
 Lacquer, VG = Truffle Grey, VK = Soft Grey, E8 = White Wood, PN = Elm
 Impreso, RH = Oak Kansas, RK = Stone Oak, VH = Arizona Oak, VJ =
 Nordic Oak

LEGATO

€ excl. VAT

Registered design

Produced to order (Please note that it is not always possible to cancel or change orders!), The washbasins are to be ordered separately.

	VANITY UNIT	VANITY UNIT	VANITY UNIT	VANITY UNIT
				
Article number	B597 00 XX	B597 L0 XX	B598 00 XX	B598 L0 XX
Dimensions (w x h x d)	1600 x 380 x 500 mm	1600 x 380 x 500 mm	1600 x 550 x 500 mm	1600 x 550 x 500 mm
Version	washbasin on right	washbasin on right	washbasin on right	washbasin on right
For combination with	Loop & Friends 5144 00/01, 5148 00/01, 5151 00/01/10/11, 5154 00/01 My Nature 4110 80/60 Artis 4179 43, 4198 61, 4172 58, 4178 41 Collaro 4A18 40, 4A21 38, 4A19 56, 4A20 56 Loop&Friends 4A45 00/01, 4A46 00/01, 4A47 00/01, 4A48 00/01, 4A49 00/01, 4A50 00/01	Loop & Friends 5144 00/01, 5148 00/01, 5151 00/01/10/11, 5154 00/01 My Nature 4110 80/60 Artis 4179 43, 4198 61, 4172 58, 4178 41 Collaro 4A18 40, 4A21 38, 4A19 56, 4A20 56 Loop&Friends 4A45 00/01, 4A46 00/01, 4A47 00/01, 4A48 00/01, 4A49 00/01, 4A50 00/01	Loop & Friends 5144 00/01, 5148 00/01, 5151 00/01/10/11, 5154 00/01 My Nature 4110 80/60 Artis 4179 43, 4198 61, 4172 58, 4178 41 Collaro 4A18 40, 4A21 38, 4A19 56, 4A20 56 Loop&Friends 4A45 00/01, 4A46 00/01, 4A47 00/01, 4A48 00/01, 4A49 00/01, 4A50 00/01	Loop & Friends 5144 00/01, 5148 00/01, 5151 00/01/10/11, 5154 00/01 My Nature 4110 80/60 Artis 4179 43, 4198 61, 4172 58, 4178 41 Collaro 4A18 40, 4A21 38, 4A19 56, 4A20 56 Loop&Friends 4A45 00/01, 4A46 00/01, 4A47 00/01, 4A48 00/01, 4A49 00/01, 4A50 00/01
Lighting	-	LED lighting Lighting 1x LED / 34,1 W	-	LED lighting Lighting 1x LED / 34,1 W
Equipped with	2x Accessories package 1 2x pull-out compartment with non-slip mat	2x Accessories package 1 2x pull-out compartment with non-slip mat	2x Accessories package 1 4x pull-out compartment with non-slip mat	2x Accessories package 1 4x pull-out compartment with non-slip mat
Note on standard	-	IP 44	-	IP 44
Installation	wall-mounted	wall-mounted	wall-mounted	wall-mounted
Scope of delivery	fastening set included	fastening set included	fastening set included	fastening set included
DH, E8, FP, MS, PN, RH, RK, VG, VH, VJ, VK				
PD				





XX = Insert front and body colour
 DH = Glossy White, FP = Glossy Grey, MS = White Matt, PD = Black Matt
 Lacquer, VG = Truffle Grey, VK = Soft Grey, E8 = White Wood, PN = Elm
 Impreso, RH = Oak Kansas, RK = Stone Oak, VH = Arizona Oak, VJ =
 Nordic Oak





LEGATO

€ excl. VAT

Registered design

Produced to order (Please note that it is not always possible to cancel or change orders!), The washbasins are to be ordered separately.

	VANITY UNIT	VANITY UNIT	VANITY UNIT	VANITY UNIT
				
Article number	B591 00 XX	B591 L0 XX	B592 00 XX	B592 L0 XX
Dimensions (w x h x d)	1400 x 380 x 500 mm	1400 x 380 x 500 mm	1400 x 550 x 500 mm	1400 x 550 x 500 mm
Version	for 2 washbasins	for 2 washbasins	for 2 washbasins	for 2 washbasins
For combination with	Loop & Friends 5144 00/01, 5148 00/01, 5151 00/01 Artis 4179 43, 4178 41 Collaro 4A18 40, 4A21 38, 4A19 56, 4A20 56 Loop&Friends 4A45 00/01, 4A46 00/01, 4A47 00/01, 4A49 00/01	Loop & Friends 5144 00/01, 5148 00/01, 5151 00/01 Artis 4179 43, 4178 41 Collaro 4A18 40, 4A21 38, 4A19 56, 4A20 56 Loop&Friends 4A45 00/01, 4A46 00/01, 4A47 00/01, 4A49 00/01	Loop & Friends 5144 00/01, 5148 00/01, 5151 00/01 Artis 4179 43, 4178 41 Collaro 4A18 40, 4A21 38, 4A19 56, 4A20 56 Loop&Friends 4A45 00/01, 4A46 00/01, 4A47 00/01, 4A49 00/01	Loop & Friends 5144 00/01, 5148 00/01, 5151 00/01 Artis 4179 43, 4178 41 Collaro 4A18 40, 4A21 38, 4A19 56, 4A20 56 Loop&Friends 4A45 00/01, 4A46 00/01, 4A47 00/01, 4A49 00/01
Lighting	-	LED lighting Lighting 1x LED / 31 W	-	LED lighting Lighting 1x LED / 31 W
Equipped with	2x Accessories package 1 2x pull-out compartment with non-slip mat	2x Accessories package 1 2x pull-out compartment with non-slip mat	2x Accessories package 1 4x pull-out compartment with non-slip mat	2x Accessories package 1 4x pull-out compartment with non-slip mat
Note on standard	-	IP 44	-	IP 44
Installation	wall-mounted	wall-mounted	wall-mounted	wall-mounted
Scope of delivery	fastening set included	fastening set included	fastening set included	fastening set included
DH, E8, FP, MS, PN, RH, RK, VG, VH, VJ, VK				
PD				

	VANITY UNIT	VANITY UNIT	VANITY UNIT	VANITY UNIT
				
Article number	B585 00 XX	B585 L0 XX	B586 00 XX	B586 L0 XX
Dimensions (w x h x d)	1400 x 380 x 500 mm	1400 x 380 x 500 mm	1400 x 550 x 500 mm	1400 x 550 x 500 mm
Version	washbasin on the middle	washbasin on the middle	washbasin on the middle	washbasin on the middle
For combination with	Loop & Friends 5144 00/01, 5148 00/01, 5151 00/01/10/11, 5154 00/01 My Nature 4110 80/60 Artis 4179 43, 4198 61, 4172 58, 4178 41 Collaro 4A18 40, 4A21 38, 4A19 56, 4A20 56 Loop&Friends 4A45 00/01, 4A46 00/01, 4A47 00/01, 4A48 00/01, 4A49 00/01, 4A50 00/01	Loop & Friends 5144 00/01, 5148 00/01, 5151 00/01/10/11, 5154 00/01 My Nature 4110 80/60 Artis 4179 43, 4198 61, 4172 58, 4178 41 Collaro 4A18 40, 4A21 38, 4A19 56, 4A20 56 Loop&Friends 4A45 00/01, 4A46 00/01, 4A47 00/01, 4A48 00/01, 4A49 00/01, 4A50 00/01	Loop & Friends 5144 00/01, 5148 00/01, 5151 00/01/10/11, 5154 00/01 My Nature 4110 80/60 Artis 4179 43, 4198 61, 4172 58, 4178 41 Collaro 4A18 40, 4A21 38, 4A19 56, 4A20 56 Loop&Friends 4A45 00/01, 4A46 00/01, 4A47 00/01, 4A48 00/01, 4A49 00/01, 4A50 00/01	Loop & Friends 5144 00/01, 5148 00/01, 5151 00/01/10/11, 5154 00/01 My Nature 4110 80/60 Artis 4179 43, 4198 61, 4172 58, 4178 41 Collaro 4A18 40, 4A21 38, 4A19 56, 4A20 56 Loop&Friends 4A45 00/01, 4A46 00/01, 4A47 00/01, 4A48 00/01, 4A49 00/01, 4A50 00/01
Lighting	-	LED lighting Lighting 1x LED / 31 W	-	LED lighting Lighting 1x LED / 31 W
Equipped with	2x Accessories package 1 3x pull-out compartment with non-slip mat	2x Accessories package 1 3x pull-out compartment with non-slip mat	2x Accessories package 1 5x pull-out compartment with non-slip mat	2x Accessories package 1 5x pull-out compartment with non-slip mat
Note on standard	-	IP 44	-	IP 44
Installation	wall-mounted	wall-mounted	wall-mounted	wall-mounted
Scope of delivery	fastening set included	fastening set included	fastening set included	fastening set included
DH, E8, FP, MS, PN, RH, RK, VG, VH, VJ, VK				
PD				



XX = Insert front and body colour
 DH = Glossy White, FP = Glossy Grey, MS = White Matt, PD = Black Matt
 Lacquer, VG = Truffle Grey, VK = Soft Grey, E8 = White Wood, PN = Elm
 Impreso, RH = Oak Kansas, RK = Stone Oak, VH = Arizona Oak, VJ =
 Nordic Oak

LEGATO

€ excl. VAT

Registered design

Produced to order (Please note that it is not always possible to cancel or change orders!), The washbasins are to be ordered separately.

	VANITY UNIT	VANITY UNIT	VANITY UNIT	VANITY UNIT
				
Article number	B587 00 XX	B587 L0 XX	B588 00 XX	B588 L0 XX
Dimensions (w x h x d)	1400 x 380 x 500 mm	1400 x 380 x 500 mm	1400 x 550 x 500 mm	1400 x 550 x 500 mm
Version	washbasin on left	washbasin on left	washbasin on left	washbasin on left
For combination with	Loop & Friends 5144 00/01, 5148 00/01, 5151 00/01/10/11, 5154 00/01 My Nature 4110 60 Artis 4179 43, 4198 61, 4172 58, 4178 41 Collaro 4A18 40, 4A21 38, 4A19 56, 4A20 56 Loop&Friends 4A45 00/01, 4A46 00/01, 4A47 00/01, 4A48 00/01, 4A49 00/01, 4A50 00/01	Loop & Friends 5144 00/01, 5148 00/01, 5151 00/01/10/11, 5154 00/01 My Nature 4110 60 Artis 4179 43, 4198 61, 4172 58, 4178 41 Collaro 4A18 40, 4A21 38, 4A19 56, 4A20 56 Loop&Friends 4A45 00/01, 4A46 00/01, 4A47 00/01, 4A48 00/01, 4A49 00/01, 4A50 00/01	Loop & Friends 5144 00/01, 5148 00/01, 5151 00/01/10/11, 5154 00/01 My Nature 4110 60 Artis 4179 43, 4198 61, 4172 58, 4178 41 Collaro 4A18 40, 4A21 38, 4A19 56, 4A20 56 Loop&Friends 4A45 00/01, 4A46 00/01, 4A47 00/01, 4A48 00/01, 4A49 00/01, 4A50 00/01	Loop & Friends 5144 00/01, 5148 00/01, 5151 00/01/10/11, 5154 00/01 My Nature 4110 60 Artis 4179 43, 4198 61, 4172 58, 4178 41 Collaro 4A18 40, 4A21 38, 4A19 56, 4A20 56 Loop&Friends 4A45 00/01, 4A46 00/01, 4A47 00/01, 4A48 00/01, 4A49 00/01, 4A50 00/01
Lighting	-	LED lighting Lighting 1x LED / 31 W	-	LED lighting Lighting 1x LED / 27,9 W
Equipped with	2x Accessories package 1 2x pull-out compartment with non-slip mat	2x Accessories package 1 2x pull-out compartment with non-slip mat	2x Accessories package 1 4x pull-out compartment with non-slip mat	2x Accessories package 1 4x pull-out compartment with non-slip mat
Note on standard	-	IP 44	-	IP 44
Installation	wall-mounted	wall-mounted	wall-mounted	wall-mounted
Scope of delivery	fastening set included	fastening set included	fastening set included	fastening set included
DH, E8, FP, MS, PN, RH, RK, VG, VH, VJ, VK				
PD				





XX = Insert front and body colour
 DH = Glossy White, FP = Glossy Grey, MS = White Matt, PD = Black Matt
 Lacquer, VG = Truffle Grey, VK = Soft Grey, E8 = White Wood, PN = Elm
 Impreso, RH = Oak Kansas, RK = Stone Oak, VH = Arizona Oak, VJ =
 Nordic Oak





LEGATO

€ excl. VAT

Registered design

Produced to order (Please note that it is not always possible to cancel or change orders!), The washbasins are to be ordered separately.

	VANITY UNIT	VANITY UNIT	VANITY UNIT	VANITY UNIT
				
Article number	B589 00 XX	B589 L0 XX	B590 00 XX	B590 L0 XX
Dimensions (w x h x d)	1400 x 380 x 500 mm	1400 x 380 x 500 mm	1400 x 550 x 500 mm	1400 x 550 x 500 mm
Version	washbasin on right	washbasin on right	washbasin on right	washbasin on right
For combination with	Loop & Friends 5144 00/01, 5148 00/01, 5151 00/01/10/11, 5154 00/01 My Nature 4110 60 Artis 4179 43, 4198 61, 4172 58, 4178 41 Collaro 4A18 40, 4A21 38, 4A19 56, 4A20 56 Loop&Friends 4A45 00/01, 4A46 00/01, 4A47 00/01, 4A48 00/01, 4A49 00/01, 4A50 00/01	Artis 4179 43, 4198 61, 4172 58, 4178 41 Loop & Friends 5144 00/01, 5148 00/01, 5151 00/01/10/11, 5154 00/01 My Nature 4110 60 Collaro 4A18 40, 4A21 38, 4A19 56, 4A20 56 Loop&Friends 4A45 00/01, 4A46 00/01, 4A47 00/01, 4A48 00/01, 4A49 00/01, 4A50 00/01	Loop & Friends 5144 00/01, 5148 00/01, 5151 00/01/10/11, 5154 00/01 My Nature 4110 60 Artis 4179 43, 4198 61, 4172 58, 4178 41 Collaro 4A18 40, 4A21 38, 4A19 56, 4A20 56 Loop&Friends 4A45 00/01, 4A46 00/01, 4A47 00/01, 4A48 00/01, 4A49 00/01, 4A50 00/01	Loop & Friends 5144 00/01, 5148 00/01, 5151 00/01/10/11, 5154 00/01 My Nature 4110 60 Artis 4179 43, 4198 61, 4172 58, 4178 41 Collaro 4A18 40, 4A21 38, 4A19 56, 4A20 56 Loop&Friends 4A45 00/01, 4A46 00/01, 4A47 00/01, 4A48 00/01, 4A49 00/01, 4A50 00/01
Lighting	-	LED lighting Lighting 1x LED / 31 W	-	LED lighting Lighting 1x LED / 31 W
Equipped with	2x Accessories package 1 2x pull-out compartment with non-slip mat	2x Accessories package 1 2x pull-out compartment with non-slip mat	2x Accessories package 1 4x pull-out compartment with non-slip mat	2x Accessories package 1 4x pull-out compartment with non-slip mat
Note on standard	-	IP 44	-	IP 44
Installation	wall-mounted	wall-mounted	wall-mounted	wall-mounted
Scope of delivery	fastening set included	fastening set included	fastening set included	fastening set included
DH, E8, FP, MS, PN, RH, RK, VG, VH, VJ, VK				
PD				

	VANITY UNIT	VANITY UNIT	VANITY UNIT	VANITY UNIT
				
Article number	B583 00 XX	B583 L0 XX	B584 00 XX	B584 L0 XX
Dimensions (w x h x d)	1200 x 380 x 500 mm	1200 x 380 x 500 mm	1200 x 550 x 500 mm	1200 x 550 x 500 mm
Version	for 2 washbasins	for 2 washbasins	for 2 washbasins	for 2 washbasins
For combination with	Artis 4179 43, 4178 41 Collaro 4A18 40, 4A21 38, 4A19 56, 4A20 56 Loop & Friends 5144 00/01, 5148 00/01 Loop&Friends 4A45 00/01, 4A46 00/01	Artis 4179 43, 4178 41 Collaro 4A18 40, 4A21 38, 4A19 56, 4A20 56 Loop & Friends 5144 00/01, 5148 00/01 Loop&Friends 4A45 00/01, 4A46 00/01	Artis 4179 43, 4178 41 Collaro 4A18 40, 4A21 38, 4A19 56, 4A20 56 Loop & Friends 5144 00/01, 5148 00/01 Loop&Friends 4A45 00/01, 4A46 00/01	Artis 4179 43, 4178 41 Collaro 4A18 40, 4A21 38, 4A19 56, 4A20 56 Loop & Friends 5144 00/01, 5148 00/01 Loop&Friends 4A45 00/01, 4A46 00/01
Lighting	-	LED lighting Lighting 1x LED / 27,9 W	-	LED lighting Lighting 1x LED / 27,9 W
Equipped with	2x Accessories package 1 2x pull-out compartment with non-slip mat	2x Accessories package 1 2x pull-out compartment with non-slip mat	2x Accessories package 1 4x pull-out compartment with non-slip mat	2x Accessories package 1 4x pull-out compartment with non-slip mat
Note on standard	-	IP 44	-	IP 44
Installation	wall-mounted	wall-mounted	wall-mounted	wall-mounted
Scope of delivery	fastening set included	fastening set included	fastening set included	fastening set included
DH, E8, FP, MS, PN, RH, RK, VG, VH, VJ, VK				
PD				



XX = Insert front and body colour
 DH = Glossy White, FP = Glossy Grey, MS = White Matt, PD = Black Matt
 Lacquer, VG = Truffle Grey, VK = Soft Grey, E8 = White Wood, PN = Elm
 Impreso, RH = Oak Kansas, RK = Stone Oak, VH = Arizona Oak, VJ = Nordic Oak



LEGATO

€ excl. VAT

Registered design

Produced to order (Please note that it is not always possible to cancel or change orders!), The washbasins are to be ordered separately.

	VANITY UNIT	VANITY UNIT	VANITY UNIT	VANITY UNIT
				
Article number	B577 00 XX	B577 L0 XX	B578 00 XX	B578 L0 XX
Dimensions (w x h x d)	1200 x 380 x 500 mm	1200 x 380 x 500 mm	1200 x 550 x 500 mm	1200 x 550 x 500 mm
Version	washbasin on the middle	washbasin on the middle	washbasin on the middle	washbasin on the middle
For combination with	Loop & Friends 5144 00/01, 5148 00/01, 5151 00/01/10/11, 5154 00/01 My Nature 4110 80/60 Artis 4179 43, 4198 61, 4172 58, 4178 41 Collaro 4A18 40, 4A21 38, 4A19 56, 4A20 56 Loop&Friends 4A45 00/01, 4A46 00/01, 4A47 00/01, 4A48 00/01, 4A49 00/01, 4A50 00/01	Loop & Friends 5144 00/01, 5148 00/01, 5151 00/01/10/11, 5154 00/01 My Nature 4110 80/60 Artis 4179 43, 4198 61, 4172 58, 4178 41 Collaro 4A18 40, 4A21 38, 4A19 56, 4A20 56 Loop&Friends 4A45 00/01, 4A46 00/01, 4A47 00/01, 4A48 00/01, 4A49 00/01, 4A50 00/01	Loop & Friends 5144 00/01, 5148 00/01, 5151 00/01/10/11, 5154 00/01 My Nature 4110 80/60 Artis 4179 43, 4198 61, 4172 58, 4178 41 Collaro 4A18 40, 4A21 38, 4A19 56, 4A20 56 Loop&Friends 4A45 00/01, 4A46 00/01, 4A47 00/01, 4A48 00/01, 4A49 00/01, 4A50 00/01	Loop & Friends 5144 00/01, 5148 00/01, 5151 00/01/10/11, 5154 00/01 My Nature 4110 80/60 Artis 4179 43, 4198 61, 4172 58, 4178 41 Collaro 4A18 40, 4A21 38, 4A19 56, 4A20 56 Loop&Friends 4A45 00/01, 4A46 00/01, 4A47 00/01, 4A48 00/01, 4A49 00/01, 4A50 00/01
Lighting	-	LED lighting Lighting 1x LED / 27,9 W	-	LED lighting Lighting 1x LED / 27,9 W
Equipped with	1x Accessories package 1 3x pull-out compartment with non-slip mat	1x Accessories package 1 3x pull-out compartment with non-slip mat	1x Accessories package 1 5x pull-out compartment with non-slip mat	1x Accessories package 1 5x pull-out compartment with non-slip mat
Note on standard	-	IP 44	-	IP 44
Installation	wall-mounted	wall-mounted	wall-mounted	wall-mounted
Scope of delivery	fastening set included	fastening set included	fastening set included	fastening set included
DH, E8, FP, MS, PN, RH, RK, VG, VH, VJ, VK				
PD				

	VANITY UNIT	VANITY UNIT	VANITY UNIT	VANITY UNIT
				
Article number	B579 00 XX	B579 L0 XX	B580 00 XX	B580 L0 XX
Dimensions (w x h x d)	1200 x 380 x 500 mm	1200 x 380 x 500 mm	1200 x 550 x 500 mm	1200 x 550 x 500 mm
Version	washbasin on left	washbasin on left	washbasin on left	washbasin on left
For combination with	My Nature 4110 60 Artis 4179 43, 4178 41 Collaro 4A18 40, 4A21 38, 4A19 56, 4A20 56 Loop & Friends 5144 00/01, 5148 00/01 Loop&Friends 4A45 00/01, 4A46 00/01	My Nature 4110 60 Artis 4179 43, 4178 41 Collaro 4A18 40, 4A21 38, 4A19 56, 4A20 56 Loop & Friends 5144 00/01, 5148 00/01 Loop&Friends 4A45 00/01, 4A46 00/01	My Nature 4110 60 Artis 4179 43, 4178 41 Collaro 4A18 40, 4A21 38, 4A19 56, 4A20 56 Loop & Friends 5144 00/01, 5148 00/01 Loop&Friends 4A45 00/01, 4A46 00/01	My Nature 4110 60 Artis 4179 43, 4178 41 Collaro 4A18 40, 4A21 38, 4A19 56, 4A20 56 Loop & Friends 5144 00/01, 5148 00/01 Loop&Friends 4A45 00/01, 4A46 00/01
Lighting	-	LED lighting Lighting 1x LED / 27,9 W	-	LED lighting Lighting 1x LED / 27,9 W
Equipped with	2x Accessories package 1 2x pull-out compartment with non-slip mat	2x Accessories package 1 2x pull-out compartment with non-slip mat	2x Accessories package 1 4x pull-out compartment with non-slip mat	2x Accessories package 1 4x pull-out compartment with non-slip mat
Note on standard	-	IP 44	-	IP 44
Installation	wall-mounted	wall-mounted	wall-mounted	wall-mounted
Scope of delivery	fastening set included	fastening set included	fastening set included	fastening set included
DH, E8, FP, MS, PN, RH, RK, VG, VH, VJ, VK				
PD				

XX = Insert front and body colour
 DH = Glossy White, FP = Glossy Grey, MS = White Matt, PD = Black Matt
 Lacquer, VG = Truffle Grey, VK = Soft Grey, E8 = White Wood, PN = Elm
 Impresso, RH = Oak Kansas, RK = Stone Oak, VH = Arizona Oak, VJ =
 Nordic Oak





LEGATO

LEGATO

€ excl. VAT

Registered design

Produced to order (Please note that it is not always possible to cancel or change orders!), The washbasins are to be ordered separately.

	VANITY UNIT	VANITY UNIT	VANITY UNIT	VANITY UNIT
				
Article number	B581 00 XX	B581 L0 XX	B582 00 XX	B582 L0 XX
Dimensions (w x h x d)	1200 x 380 x 500 mm	1200 x 380 x 500 mm	1200 x 550 x 500 mm	1200 x 550 x 500 mm
Version	washbasin on right	washbasin on right	washbasin on right	washbasin on right
For combination with	My Nature 4110 60 Artis 4179 43, 4178 41 Collaro 4A18 40, 4A21 38, 4A19 56, 4A20 56 Loop & Friends 5144 00/01, 5148 00/01 Loop&Friends 4A45 00/01, 4A46 00/01	Artis 4179 43, 4178 41 My Nature 4110 60 Collaro 4A18 40, 4A21 38, 4A19 56, 4A20 56 Loop & Friends 5144 00/01, 5148 00/01 Loop&Friends 4A45 00/01, 4A46 00/01	My Nature 4110 60 Artis 4179 43, 4178 41 Collaro 4A18 40, 4A21 38, 4A19 56, 4A20 56 Loop & Friends 5144 00/01, 5148 00/01 Loop&Friends 4A45 00/01, 4A46 00/01	My Nature 4110 60 Artis 4179 43, 4178 41 Collaro 4A18 40, 4A21 38, 4A19 56, 4A20 56 Loop & Friends 5144 00/01, 5148 00/01 Loop&Friends 4A45 00/01, 4A46 00/01
Lighting	-	LED lighting Lighting 1x LED / 27,9 W	-	LED lighting Lighting 1x LED / 27,9 W
Equipped with	2x Accessories package 1 2x pull-out compartment with non-slip mat	2x Accessories package 1 2x pull-out compartment with non-slip mat	2x Accessories package 1 4x pull-out compartment with non-slip mat	2x Accessories package 1 4x pull-out compartment with non-slip mat
Note on standard	-	IP 44	-	IP 44
Installation	wall-mounted	wall-mounted	wall-mounted	wall-mounted
Scope of delivery	fastening set included	fastening set included	fastening set included	fastening set included
DH, E8, FP, MS, PN, RH, RK, VG, VH, VJ, VK				
PD				

XX = Insert front and body colour



 DH = Glossy White, FP = Glossy Grey, MS = White Matt, PD = Black Matt
 Lacquer, VG = Truffle Grey, VK = Soft Grey, E8 = White Wood, PN = Elm
 Impreso, RH = Oak Kansas, RK = Stone Oak, VH = Arizona Oak, VJ =
 Nordic Oak



LEGATO

€ excl. VAT

Registered design

Produced to order (Please note that it is not always possible to cancel or change orders!), The washbasins are to be ordered separately.

	VANITY UNIT	VANITY UNIT	VANITY UNIT	VANITY UNIT
				
Article number	B571 00 XX	B571 L0 XX	B572 00 XX	B572 L0 XX
Dimensions (w x h x d)	1000 x 380 x 500 mm	1000 x 380 x 500 mm	1000 x 550 x 500 mm	1000 x 550 x 500 mm
Version	washbasin on the middle	washbasin on the middle	washbasin on the middle	washbasin on the middle
For combination with	Loop & Friends 5144 00/01, 5148 00/01, 5151 00/01/10/11, 5154 00/01 My Nature 4110 80/60 Artis 4179 43, 4198 61, 4172 58, 4178 41 Collaro 4A18 40, 4A21 38, 4A19 56, 4A20 56 Loop&Friends 4A45 00/01, 4A46 00/01, 4A47 00/01, 4A48 00/01, 4A49 00/01, 4A50 00/01	Loop & Friends 5144 00/01, 5148 00/01, 5151 00/01/10/11, 5154 00/01 My Nature 4110 80/60 Artis 4179 43, 4198 61, 4172 58, 4178 41 Collaro 4A18 40, 4A21 38, 4A19 56, 4A20 56 Loop&Friends 4A45 00/01, 4A46 00/01, 4A47 00/01, 4A48 00/01, 4A49 00/01, 4A50 00/01	Loop & Friends 5144 00/01, 5148 00/01, 5151 00/01/10/11, 5154 00/01 My Nature 4110 80/60 Artis 4179 43, 4198 61, 4172 58, 4178 41 Collaro 4A18 40, 4A21 38, 4A19 56, 4A20 56 Loop&Friends 4A45 00/01, 4A46 00/01, 4A47 00/01, 4A48 00/01, 4A49 00/01, 4A50 00/01	Loop & Friends 5144 00/01, 5148 00/01, 5151 00/01/10/11, 5154 00/01 My Nature 4110 80/60 Artis 4179 43, 4198 61, 4172 58, 4178 41 Collaro 4A18 40, 4A21 38, 4A19 56, 4A20 56 Loop&Friends 4A45 00/01, 4A46 00/01, 4A47 00/01, 4A48 00/01, 4A49 00/01, 4A50 00/01
Lighting	-	LED lighting Lighting 1x LED / 24,8 W	-	LED lighting Lighting 1x LED / 24,8 W
Equipped with	1x Accessories package 1 1x pull-out compartment with non-slip mat	1x Accessories package 1 1x pull-out compartment with non-slip mat	1x Accessories package 1 2x pull-out compartment with non-slip mat	1x Accessories package 1 2x pull-out compartment with non-slip mat
Note on standard	-	IP 44	-	IP 44
Installation	wall-mounted	wall-mounted	wall-mounted	wall-mounted
Scope of delivery	fastening set included	fastening set included	fastening set included	fastening set included
DH, E8, FP, MS, PN, RH, RK, VG, VH, VJ, VK				
PD				

	VANITY UNIT	VANITY UNIT	VANITY UNIT	VANITY UNIT
				
Article number	B573 00 XX	B573 L0 XX	B574 00 XX	B574 L0 XX
Dimensions (w x h x d)	1000 x 380 x 500 mm	1000 x 380 x 500 mm	1000 x 550 x 500 mm	1000 x 550 x 500 mm
Version	washbasin on left	washbasin on left	washbasin on left	washbasin on left
For combination with	Artis 4179 43, 4178 41 Collaro 4A18 40, 4A21 38, 4A19 56, 4A20 56 Loop & Friends 5144 00/01, 5148 00/01 Loop&Friends 4A45 00/01, 4A46 00/01	Artis 4179 43, 4178 41 Collaro 4A18 40, 4A21 38, 4A19 56, 4A20 56 Loop & Friends 5144 00/01, 5148 00/01 Loop&Friends 4A45 00/01, 4A46 00/01	Artis 4179 43, 4178 41 Collaro 4A18 40, 4A21 38, 4A19 56, 4A20 56 Loop & Friends 5144 00/01, 5148 00/01 Loop&Friends 4A45 00/01, 4A46 00/01	Artis 4179 43, 4178 41 Collaro 4A18 40, 4A21 38, 4A19 56, 4A20 56 Loop & Friends 5144 00/01, 5148 00/01 Loop&Friends 4A45 00/01, 4A46 00/01
Lighting	-	LED lighting Lighting 1x LED / 24,8 W	-	LED lighting Lighting 1x LED / 24,8 W
Equipped with	1x Accessories package 1 1x pull-out compartment with non-slip mat	1x Accessories package 1 1x pull-out compartment with non-slip mat	1x Accessories package 1 2x pull-out compartment with non-slip mat	1x Accessories package 1 2x pull-out compartment with non-slip mat
Note on standard	-	IP 44	-	IP 44
Installation	wall-mounted	wall-mounted	wall-mounted	wall-mounted
Scope of delivery	fastening set included	fastening set included	fastening set included	fastening set included
DH, E8, FP, MS, PN, RH, RK, VG, VH, VJ, VK				
PD				

XX = Insert front and body colour
 DH = Glossy White, FP = Glossy Grey, MS = White Matt, PD = Black Matt
 Lacquer, VG = Truffle Grey, VK = Soft Grey, E8 = White Wood, PN = Elm
 Impreso, RH = Oak Kansas, RK = Stone Oak, VH = Arizona Oak, VJ =
 Nordic Oak





LEGATO





LEGATO

€ excl. VAT

Registered design

Produced to order (Please note that it is not always possible to cancel or change orders!), The washbasins are to be ordered separately.

	VANITY UNIT	VANITY UNIT	VANITY UNIT	VANITY UNIT
				
Article number	B575 00 XX	B575 L0 XX	B576 00 XX	B576 L0 XX
Dimensions (w x h x d)	1000 x 380 x 500 mm	1000 x 380 x 500 mm	1000 x 550 x 500 mm	1000 x 550 x 500 mm
Version	washbasin on right	washbasin on right	washbasin on right	washbasin on right
For combination with	Artis 4179 43, 4178 41 Collaro 4A18 40, 4A21 38, 4A19 56, 4A20 56 Loop & Friends 5144 00/01, 5148 00/01 Loop&Friends 4A45 00/01, 4A46 00/01	Artis 4179 43, 4178 41 Collaro 4A18 40, 4A21 38, 4A19 56, 4A20 56 Loop & Friends 5144 00/01, 5148 00/01 Loop&Friends 4A45 00/01, 4A46 00/01	Artis 4179 43, 4178 41 Collaro 4A18 40, 4A21 38, 4A19 56, 4A20 56 Loop & Friends 5144 00/01, 5148 00/01 Loop&Friends 4A45 00/01, 4A46 00/01	Artis 4179 43, 4178 41 Collaro 4A18 40, 4A21 38, 4A19 56, 4A20 56 Loop & Friends 5144 00/01, 5148 00/01 Loop&Friends 4A45 00/01, 4A46 00/01
Lighting	-	LED lighting Lighting 1x LED / 24,8 W	-	LED lighting Lighting 1x LED / 24,8 W
Equipped with	1x Accessories package 1 1x pull-out compartment with non-slip mat	1x Accessories package 1 1x pull-out compartment with non-slip mat	1x Accessories package 1 2x pull-out compartment with non-slip mat	1x Accessories package 1 2x pull-out compartment with non-slip mat
Note on standard	-	IP 44	-	IP 44
Installation	wall-mounted	wall-mounted	wall-mounted	wall-mounted
Scope of delivery	fastening set included	fastening set included	fastening set included	fastening set included
DH, E8, FP, MS, PN, RH, RK, VG, VH, VJ, VK				
PD				

	VANITY UNIT	VANITY UNIT	VANITY UNIT	VANITY UNIT
				
Article number	B569 00 XX	B569 L0 XX	B570 00 XX	B570 L0 XX
Dimensions (w x h x d)	800 x 380 x 500 mm	800 x 380 x 500 mm	800 x 550 x 500 mm	800 x 550 x 500 mm
Version	washbasin on the middle	washbasin on the middle	washbasin on the middle	washbasin on the middle
For combination with	Loop & Friends 5144 00/01, 5148 00/01, 5151 00/01/10/11, 5154 00/01 My Nature 4110 60 Artis 4179 43, 4198 61, 4172 58, 4178 41 Collaro 4A18 40, 4A21 38, 4A19 56, 4A20 56 Loop&Friends 4A45 00/01, 4A46 00/01, 4A47 00/01, 4A48 00/01, 4A49 00/01, 4A50 00/01	Loop & Friends 5144 00/01, 5148 00/01, 5151 00/01/10/11, 5154 00/01 My Nature 4110 60 Artis 4179 43, 4198 61, 4172 58, 4178 41 Collaro 4A18 40, 4A21 38, 4A19 56, 4A20 56 Loop&Friends 4A45 00/01, 4A46 00/01, 4A47 00/01, 4A48 00/01, 4A49 00/01, 4A50 00/01	Collaro 4A18 40, 4A21 38, 4A19 56, 4A20 56 Loop&Friends 4A45 00/01, 4A46 00/01, 4A47 00/01, 4A48 00/01, 4A49 00/01, 4A50 00/01 Loop & Friends 5144 00/01, 5148 00/01, 5151 00/01/10/11, 5154 00/01 My Nature 4110 60 Artis 4179 43, 4198 61, 4172 58, 4178 41	Loop & Friends 5144 00/01, 5148 00/01, 5151 00/01/10/11, 5154 00/01 My Nature 4110 60 Artis 4179 43, 4198 61, 4172 58, 4178 41 Collaro 4A18 40, 4A21 38, 4A19 56, 4A20 56 Loop&Friends 4A45 00/01, 4A46 00/01, 4A47 00/01, 4A48 00/01, 4A49 00/01, 4A50 00/01
Lighting	-	LED lighting Lighting 1x LED / 21,6 W	-	LED lighting Lighting 1x LED / 21,6 W
Equipped with	1x Accessories package 1 1x pull-out compartment with non-slip mat	1x Accessories package 1 1x pull-out compartment with non-slip mat	1x Accessories package 1 2x pull-out compartment with non-slip mat	1x Accessories package 1 2x pull-out compartment with non-slip mat
Note on standard	-	IP 44	-	IP 44
Installation	wall-mounted	wall-mounted	wall-mounted	wall-mounted
Scope of delivery	fastening set included	fastening set included	fastening set included	fastening set included
DH, E8, FP, MS, PN, RH, RK, VG, VH, VJ, VK				
PD				





XX = Insert front and body colour
 DH = Glossy White, FP = Glossy Grey, MS = White Matt, PD = Black Matt
 Lacquer, VG = Truffle Grey, VK = Soft Grey, E8 = White Wood, PN = Elm
 Impreso, RH = Oak Kansas, RK = Stone Oak, VH = Arizona Oak, VJ = Nordic Oak





LEGATO

€ excl. VAT

Registered design

Produced to order (Please note that it is not always possible to cancel or change orders!), The washbasins are to be ordered separately.

	VANITY UNIT	VANITY UNIT	VANITY UNIT	VANITY UNIT
				
Article number	B567 00 XX	B567 L0 XX	B568 00 XX	B568 L0 XX
Dimensions (w x h x d)	600 x 380 x 500 mm	600 x 380 x 500 mm	600 x 550 x 500 mm	600 x 550 x 500 mm
Version	washbasin on the middle	washbasin on the middle	washbasin on the middle	washbasin on the middle
For combination with	Artis 4179 43, 4178 41 Collaro 4A18 40, 4A21 38, 4A19 56, 4A20 56 Loop & Friends 5144 00/01, 5148 00/01 Loop&Friends 4A45 00/01, 4A46 00/01	Artis 4179 43, 4178 41 Collaro 4A18 40, 4A21 38, 4A19 56, 4A20 56 Loop & Friends 5144 00/01, 5148 00/01 Loop&Friends 4A45 00/01, 4A46 00/01	Artis 4179 43, 4178 41 Collaro 4A18 40, 4A21 38, 4A19 56, 4A20 56 Loop & Friends 5144 00/01, 5148 00/01 Loop&Friends 4A45 00/01, 4A46 00/01	Artis 4179 43, 4178 41 Collaro 4A18 40, 4A21 38, 4A19 56, 4A20 56 Loop & Friends 5144 00/01, 5148 00/01 Loop&Friends 4A45 00/01, 4A46 00/01
Lighting	-	LED lighting Lighting 1x LED / 18,5 W	-	LED lighting Lighting 1x LED / 18,5 W
Equipped with	1x Accessories package 1 1x pull-out compartment with non-slip mat	1x Accessories package 1 1x pull-out compartment with non-slip mat	1x Accessories package 1 2x pull-out compartment with non-slip mat	1x Accessories package 1 2x pull-out compartment with non-slip mat
Note on standard	-	IP 44	-	IP 44
Installation	wall-mounted	wall-mounted	wall-mounted	wall-mounted
Scope of delivery	fastening set included	fastening set included	fastening set included	fastening set included
DH, E8, FP, MS, PN, RH, RK, VG, VH, VJ, VK				
PD				

	VANITY UNIT	VANITY UNIT	VANITY UNIT	VANITY UNIT
				
Article number	B565 00 XX	B565 L0 XX	B566 00 XX	B566 L0 XX
Dimensions (w x h x d)	450 x 380 x 500 mm	450 x 380 x 500 mm	450 x 550 x 500 mm	450 x 550 x 500 mm
Version	washbasin on the middle	washbasin on the middle	washbasin on the middle	washbasin on the middle
For combination with	Artis 4179 43, 4178 41 Collaro 4A18 40, 4A21 38 Loop & Friends 5144 00/01, 5148 00/01 Loop&Friends 4A45 00/01, 4A46 00/01	Loop & Friends 5144 00/01, 5148 00/01 Collaro 4A18 40, 4A21 38 Artis 4179 43, 4178 41 Loop&Friends 4A45 00/01, 4A46 00/01	Artis 4179 43, 4178 41 Collaro 4A18 40, 4A21 38 Loop & Friends 5144 00/01, 5148 00/01 Loop&Friends 4A45 00/01, 4A46 00/01	Artis 4179 43, 4178 41 Collaro 4A18 40, 4A21 38 Loop & Friends 5144 00/01, 5148 00/01 Loop&Friends 4A45 00/01, 4A46 00/01
Lighting	-	LED lighting Lighting 1x LED / 16,2 W	-	LED lighting Lighting 1x LED / 16,2 W
Equipped with	1x accessory box L 1x pull-out compartment with non-slip mat	1x accessory box L 1x pull-out compartment with non-slip mat	1x accessory box L 2x pull-out compartment with non-slip mat	1x accessory box L 2x pull-out compartment with non-slip mat
Note on standard	-	IP 44	-	IP 44
Installation	wall-mounted	wall-mounted	wall-mounted	wall-mounted
Scope of delivery	fastening set included	fastening set included	fastening set included	fastening set included
Please note	-	-	only with wall tap fitting and central pillar tap	only with wall tap fitting and central pillar tap
DH, E8, FP, MS, PN, RH, RK, VG, VH, VJ, VK				
PD				

XX = Insert front and body colour
 DH = Glossy White, FP = Glossy Grey, MS = White Matt, PD = Black Matt
 Lacquer, VG = Truffle Grey, VK = Soft Grey, E8 = White Wood, PN = Elm
 Impresso, RH = Oak Kansas, RK = Stone Oak, VH = Arizona Oak, VJ =
 Nordic Oak





LEGATO





LEGATO

€ excl. VAT

Registered design

Produced to order (Please note that it is not always possible to cancel or change orders!), The washbasins are to be ordered separately.

	VANITY UNIT	VANITY UNIT	VANITY UNIT	VANITY UNIT
				
Article number	B676 00 XX	B676 L0 XX	B677 00 XX	B677 L0 XX
Dimensions (w x h x d)	1600 x 380 x 500 mm	1600 x 380 x 500 mm	1600 x 550 x 500 mm	1600 x 550 x 500 mm
Version	for 2 washbasins	for 2 washbasins	for 2 washbasins	for 2 washbasins
For combination with	Memento 5133 6L, 5133 5L Memento 2.0 4A22 6F/6G/6L, 4A22 5F/5G/5L	Memento 5133 6L, 5133 5L Memento 2.0 4A22 6F/6G/6L, 4A22 5F/5G/5L	Memento 5133 6L, 5133 5L Memento 2.0 4A22 6F/6G/6L, 4A22 5F/5G/5L	Memento 5133 6L, 5133 5L Memento 2.0 4A22 6F/6G/6L, 4A22 5F/5G/5L
Lighting	-	LED lighting Lighting 1x LED / 34,1 W	-	LED lighting Lighting 1x LED / 34,1 W
Equipped with	2x Accessories package 1 2x pull-out compartment with non-slip mat	2x Accessories package 1 2x pull-out compartment with non-slip mat	2x Accessories package 1 4x pull-out compartment with non-slip mat	2x Accessories package 1 4x pull-out compartment with non-slip mat
Note on standard	-	IP 44	-	IP 44
Installation	wall-mounted	wall-mounted	wall-mounted	wall-mounted
Scope of delivery	fastening set included	fastening set included	fastening set included	fastening set included
Please note	no 3-hole tap fitting possible, tap holes punched out	no 3-hole tap fitting possible, tap holes punched out	no 3-hole tap fitting possible, tap holes punched out	no 3-hole tap fitting possible, tap holes punched out
DH, E8, FP, MS, PN, RH, RK, VG, VH, VJ, VK				
PD				

	VANITY UNIT	VANITY UNIT	VANITY UNIT	VANITY UNIT
				
Article number	B670 00 XX	B670 L0 XX	B671 00 XX	B671 L0 XX
Dimensions (w x h x d)	1600 x 380 x 500 mm	1600 x 380 x 500 mm	1600 x 550 x 500 mm	1600 x 550 x 500 mm
Version	washbasin on the middle	washbasin on the middle	washbasin on the middle	washbasin on the middle
For combination with	Memento 2.0 4A22 CF/CG/CH/CL, 4A22 1F/1G/1H/1K, 4A22 8F/8G/8L	Memento 2.0 4A22 CF/CG/CH/CL, 4A22 1F/1G/1H/1K, 4A22 8F/8G/8L	Memento 2.0 4A22 CF/CG/CH/CL, 4A22 1F/1G/1H/1K, 4A22 8F/8G/8L	Memento 2.0 4A22 CF/CG/CH/CL, 4A22 1F/1G/1H/1K, 4A22 8F/8G/8L
Lighting	-	LED lighting Lighting 1x LED / 34,1 W	-	LED lighting Lighting 1x LED / 34,1 W
Equipped with	2x Accessories package 1 2x pull-out compartment with non-slip mat	2x Accessories package 1 2x pull-out compartment with non-slip mat	2x Accessories package 1 4x pull-out compartment with non-slip mat	2x Accessories package 1 4x pull-out compartment with non-slip mat
Note on standard	-	IP 44	-	IP 44
Installation	wall-mounted	wall-mounted	wall-mounted	wall-mounted
Scope of delivery	fastening set included	fastening set included	fastening set included	fastening set included
Please note	no 3-hole tap fitting possible, washbasins with 2 taps and overflow only available in combination with a push-open valve, tap holes punched out	no 3-hole tap fitting possible, washbasins with 2 taps and overflow only available in combination with a push-open valve, tap holes punched out	no 3-hole tap fitting possible, washbasins with 2 taps and overflow only available in combination with a push-open valve, tap holes punched out	no 3-hole tap fitting possible, washbasins with 2 taps and overflow only available in combination with a push-open valve, tap holes punched out
DH, E8, FP, MS, PN, RH, RK, VG, VH, VJ, VK				
PD				



XX = Insert front and body colour
 DH = Glossy White, FP = Glossy Grey, MS = White Matt, PD = Black Matt
 Lacquer, VG = Truffle Grey, VK = Soft Grey, E8 = White Wood, PN = Elm
 Impresso, RH = Oak Kansas, RK = Stone Oak, VH = Arizona Oak, VJ =
 Nordic Oak



LEGATO

€ excl. VAT

Registered design

Produced to order (Please note that it is not always possible to cancel or change orders!), The washbasins are to be ordered separately.

	VANITY UNIT	VANITY UNIT	VANITY UNIT	VANITY UNIT
				
Article number	B672 00 XX	B672 L0 XX	B673 00 XX	B673 L0 XX
Dimensions (w x h x d)	1600 x 380 x 500 mm	1600 x 380 x 500 mm	1600 x 550 x 500 mm	1600 x 550 x 500 mm
Version	washbasin on left	washbasin on left	washbasin on left	washbasin on left
For combination with	Memento 5133 6L, 5133 5L Memento 2.0 4A22 6F/6G/6L, 4A22 5F/5G/5L	Memento 5133 6L, 5133 5L Memento 2.0 4A22 6F/6G/6L, 4A22 5F/5G/5L	Memento 5133 6L, 5133 5L Memento 2.0 4A22 6F/6G/6L, 4A22 5F/5G/5L	Memento 5133 6L, 5133 5L Memento 2.0 4A22 6F/6G/6L, 4A22 5F/5G/5L
Lighting	-	LED lighting Lighting 1x LED / 34,1 W	-	LED lighting Lighting 1x LED / 34,1 W
Equipped with	2x Accessories package 1 2x pull-out compartment with non-slip mat	2x Accessories package 1 2x pull-out compartment with non-slip mat	2x Accessories package 1 4x pull-out compartment with non-slip mat	2x Accessories package 1 4x pull-out compartment with non-slip mat
Note on standard	-	IP 44	-	IP 44
Installation	wall-mounted	wall-mounted	wall-mounted	wall-mounted
Scope of delivery	fastening set included	fastening set included	fastening set included	fastening set included
Please note	no 3-hole tap fitting possible, tap holes punched out	no 3-hole tap fitting possible, tap holes punched out	no 3-hole tap fitting possible, tap holes punched out	no 3-hole tap fitting possible, tap holes punched out
DH, E8, FP, MS, PN, RH, RK, VG, VH, VJ, VK				
PD				

	VANITY UNIT	VANITY UNIT	VANITY UNIT	VANITY UNIT
				
Article number	B674 00 XX	B674 L0 XX	B675 00 XX	B675 L0 XX
Dimensions (w x h x d)	1600 x 380 x 500 mm	1600 x 380 x 500 mm	1600 x 550 x 500 mm	1600 x 550 x 500 mm
Version	washbasin on right	washbasin on right	washbasin on right	washbasin on right
For combination with	Memento 5133 6L, 5133 5L Memento 2.0 4A22 6F/6G/6L, 4A22 5F/5G/5L	Memento 5133 6L, 5133 5L Memento 2.0 4A22 6F/6G/6L, 4A22 5F/5G/5L	Memento 5133 6L, 5133 5L Memento 2.0 4A22 6F/6G/6L, 4A22 5F/5G/5L	Memento 5133 6L, 5133 5L Memento 2.0 4A22 6F/6G/6L, 4A22 5F/5G/5L
Lighting	-	LED lighting Lighting 1x LED / 34,1 W	-	LED lighting Lighting 1x LED / 34,1 W
Equipped with	2x Accessories package 1 2x pull-out compartment with non-slip mat	2x Accessories package 1 2x pull-out compartment with non-slip mat	2x Accessories package 1 4x pull-out compartment with non-slip mat	2x Accessories package 1 4x pull-out compartment with non-slip mat
Note on standard	-	IP 44	-	IP 44
Installation	wall-mounted	wall-mounted	wall-mounted	wall-mounted
Scope of delivery	fastening set included	fastening set included	fastening set included	fastening set included
Please note	no 3-hole tap fitting possible, tap holes punched out	no 3-hole tap fitting possible, tap holes punched out	no 3-hole tap fitting possible, tap holes punched out	no 3-hole tap fitting possible, tap holes punched out
DH, E8, FP, MS, PN, RH, RK, VG, VH, VJ, VK				
PD				





XX = Insert front and body colour
 DH = Glossy White, FP = Glossy Grey, MS = White Matt, PD = Black Matt
 Lacquer, VG = Truffle Grey, VK = Soft Grey, E8 = White Wood, PN = Elm
 Impresso, RH = Oak Kansas, RK = Stone Oak, VH = Arizona Oak, VJ =
 Nordic Oak





LEGATO

€ excl. VAT

Registered design

Produced to order (Please note that it is not always possible to cancel or change orders!), The washbasins are to be ordered separately.

	VANITY UNIT	VANITY UNIT	VANITY UNIT	VANITY UNIT
				
Article number	B668 00 XX	B668 L0 XX	B669 00 XX	B669 L0 XX
Dimensions (w x h x d)	1400 x 380 x 500 mm	1400 x 380 x 500 mm	1400 x 550 x 500 mm	1400 x 550 x 500 mm
Version	for 2 washbasins	for 2 washbasins	for 2 washbasins	for 2 washbasins
For combination with	Memento 5133 5L Memento 2.0 4A22 5F/5G/5L	Memento 5133 5L Memento 2.0 4A22 5F/5G/5L	Memento 5133 5L Memento 2.0 4A22 5F/5G/5L	Memento 5133 5L Memento 2.0 4A22 5F/5G/5L
Lighting	-	LED lighting Lighting 1x LED / 31 W	-	LED lighting Lighting 1x LED / 31 W
Equipped with	2x Accessories package 1 2x pull-out compartment with non-slip mat	2x Accessories package 1 2x pull-out compartment with non-slip mat	2x Accessories package 1 4x pull-out compartment with non-slip mat	2x Accessories package 1 4x pull-out compartment with non-slip mat
Note on standard	-	IP 44	-	IP 44
Installation	wall-mounted	wall-mounted	wall-mounted	wall-mounted
Scope of delivery	fastening set included	fastening set included	fastening set included	fastening set included
Please note	no 3-hole tap fitting possible, tap holes punched out	no 3-hole tap fitting possible, tap holes punched out	no 3-hole tap fitting possible, tap holes punched out	no 3-hole tap fitting possible, tap holes punched out
DH, E8, FP, MS, PN, RH, RK, VG, VH, VJ, VK				
PD				

	VANITY UNIT	VANITY UNIT	VANITY UNIT	VANITY UNIT
				
Article number	B611 00 XX	B611 L0 XX	B612 00 XX	B612 L0 XX
Dimensions (w x h x d)	1400 x 380 x 500 mm	1400 x 380 x 500 mm	1400 x 550 x 500 mm	1400 x 550 x 500 mm
Version	washbasin on the middle	washbasin on the middle	washbasin on the middle	washbasin on the middle
For combination with	Memento 2.0 4A22 CF/CG/CH/CL, 4A22 1F/1G/1H/1K, 4A22 8F/8G/8L	Memento 2.0 4A22 CF/CG/CH/CL, 4A22 1F/1G/1H/1K, 4A22 8F/8G/8L	Memento 2.0 4A22 CF/CG/CH/CL, 4A22 1F/1G/1H/1K, 4A22 8F/8G/8L	Memento 2.0 4A22 CF/CG/CH/CL, 4A22 1F/1G/1H/1K, 4A22 8F/8G/8L
Lighting	-	LED lighting Lighting 1x LED / 31 W	-	LED lighting Lighting 1x LED / 31 W
Equipped with	2x Accessories package 1 2x pull-out compartment with non-slip mat	2x Accessories package 1 2x pull-out compartment with non-slip mat	2x Accessories package 1 4x pull-out compartment with non-slip mat	2x Accessories package 1 4x pull-out compartment with non-slip mat
Note on standard	-	IP 44	-	IP 44
Installation	wall-mounted	wall-mounted	wall-mounted	wall-mounted
Scope of delivery	fastening set included	fastening set included	fastening set included	fastening set included
Please note	no 3-hole tap fitting possible, washbasins with 2 taps and overflow only available in combination with a push-open valve, tap holes punched out	no 3-hole tap fitting possible, washbasins with 2 taps and overflow only available in combination with a push-open valve, tap holes punched out	no 3-hole tap fitting possible, washbasins with 2 taps and overflow only available in combination with a push-open valve, tap holes punched out	no 3-hole tap fitting possible, washbasins with 2 taps and overflow only available in combination with a push-open valve, tap holes punched out
DH, E8, FP, MS, PN, RH, RK, VG, VH, VJ, VK				
PD				





XX = Insert front and body colour
 DH = Glossy White, FP = Glossy Grey, MS = White Matt, PD = Black Matt
 Lacquer, VG = Truffle Grey, VK = Soft Grey, E8 = White Wood, PN = Elm
 Impresso, RH = Oak Kansas, RK = Stone Oak, VH = Arizona Oak, VJ =
 Nordic Oak

LEGATO

€ excl. VAT

Registered design

Produced to order (Please note that it is not always possible to cancel or change orders!), The washbasins are to be ordered separately.

	VANITY UNIT	VANITY UNIT	VANITY UNIT	VANITY UNIT
				
Article number	B613 00 XX	B613 L0 XX	B614 00 XX	B614 L0 XX
Dimensions (w x h x d)	1400 x 380 x 500 mm	1400 x 380 x 500 mm	1400 x 550 x 500 mm	1400 x 550 x 500 mm
Version	washbasin on left	washbasin on left	washbasin on left	washbasin on left
For combination with	Memento 5133 5L Memento 2.0 4A22 5F/5G/5L	Memento 5133 5L Memento 2.0 4A22 5F/5G/5L	Memento 5133 5L Memento 2.0 4A22 5F/5G/5L	Memento 5133 5L Memento 2.0 4A22 5F/5G/5L
Lighting	-	LED lighting Lighting 1x LED / 31 W	-	LED lighting Lighting 1x LED / 31 W
Equipped with	2x Accessories package 1 2x pull-out compartment with non-slip mat	2x Accessories package 1 2x pull-out compartment with non-slip mat	2x Accessories package 1 4x pull-out compartment with non-slip mat	2x Accessories package 1 4x pull-out compartment with non-slip mat
Note on standard	-	IP 44	-	IP 44
Installation	wall-mounted	wall-mounted	wall-mounted	wall-mounted
Scope of delivery	fastening set included	fastening set included	fastening set included	fastening set included
Please note	no 3-hole tap fitting possible, tap holes punched out	no 3-hole tap fitting possible, tap holes punched out	no 3-hole tap fitting possible, tap holes punched out	no 3-hole tap fitting possible, tap holes punched out
DH, E8, FP, MS, PN, RH, RK, VG, VH, VJ, VK				
PD				
	VANITY UNIT	VANITY UNIT	VANITY UNIT	VANITY UNIT
				
Article number	B615 00 XX	B615 L0 XX	B616 00 XX	B616 L0 XX
Dimensions (w x h x d)	1400 x 380 x 500 mm	1400 x 380 x 500 mm	1400 x 550 x 500 mm	1400 x 550 x 500 mm
Version	washbasin on right	washbasin on right	washbasin on right	washbasin on right
For combination with	Memento 5133 5L Memento 2.0 4A22 5F/5G/5L	Memento 5133 5L Memento 2.0 4A22 5F/5G/5L	Memento 5133 5L Memento 2.0 4A22 5F/5G/5L	Memento 5133 5L Memento 2.0 4A22 5F/5G/5L
Lighting	-	LED lighting Lighting 1x LED / 31 W	-	LED lighting Lighting 1x LED / 31 W
Equipped with	2x Accessories package 1 2x pull-out compartment with non-slip mat	2x Accessories package 1 2x pull-out compartment with non-slip mat	2x Accessories package 1 4x pull-out compartment with non-slip mat	2x Accessories package 1 4x pull-out compartment with non-slip mat
Note on standard	-	IP 44	-	IP 44
Installation	wall-mounted	wall-mounted	wall-mounted	wall-mounted
Scope of delivery	fastening set included	fastening set included	fastening set included	fastening set included
Please note	no 3-hole tap fitting possible, tap holes punched out	no 3-hole tap fitting possible, tap holes punched out	no 3-hole tap fitting possible, tap holes punched out	no 3-hole tap fitting possible, tap holes punched out
DH, E8, FP, MS, PN, RH, RK, VG, VH, VJ, VK				
PD				

LEGATO





XX = Insert front and body colour
 DH = Glossy White, FP = Glossy Grey, MS = White Matt, PD = Black Matt
 Lacquer, VG = Truffle Grey, VK = Soft Grey, E8 = White Wood, PN = Elm
 Impreso, RH = Oak Kansas, RK = Stone Oak, VH = Arizona Oak, VJ =
 Nordic Oak





LEGATO

€ excl. VAT

Registered design

Produced to order (Please note that it is not always possible to cancel or change orders!), The washbasins are to be ordered separately.

	VANITY UNIT	VANITY UNIT	VANITY UNIT	VANITY UNIT
				
Article number	B609 00 XX	B609 L0 XX	B610 00 XX	B610 L0 XX
Dimensions (w x h x d)	1200 x 380 x 500 mm	1200 x 380 x 500 mm	1200 x 550 x 500 mm	1200 x 550 x 500 mm
Version	washbasin on the middle	washbasin on the middle	washbasin on the middle	washbasin on the middle
For combination with	Memento 2.0 4A22 1F/1G/1H/1K, 4A22 8F/8G/8L	Memento 2.0 4A22 1F/1G/1H/1K, 4A22 8F/8G/8L	Memento 2.0 4A22 1F/1G/1H/1K, 4A22 8F/8G/8L	Memento 2.0 4A22 1F/1G/1H/1K, 4A22 8F/8G/8L
Lighting	-	LED lighting Lighting 1x LED / 27,9 W	-	LED lighting Lighting 1x LED / 27,9 W
Equipped with	2x Accessories package 1 2x pull-out compartment with non-slip mat	2x Accessories package 1 2x pull-out compartment with non-slip mat	2x Accessories package 1 4x pull-out compartment with non-slip mat	2x Accessories package 1 4x pull-out compartment with non-slip mat
Note on standard	-	IP 44	-	IP 44
Installation	wall-mounted	wall-mounted	wall-mounted	wall-mounted
Scope of delivery	fastening set included	fastening set included	fastening set included	fastening set included
Please note	no 3-hole tap fitting possible, washbasins with 2 taps and overflow only available in combination with a push-open valve, tap holes punched out	no 3-hole tap fitting possible, washbasins with 2 taps and overflow only available in combination with a push-open valve, tap holes punched out	no 3-hole tap fitting possible, washbasins with 2 taps and overflow only available in combination with a push-open valve, tap holes punched out	no 3-hole tap fitting possible, washbasins with 2 taps and overflow only available in combination with a push-open valve, tap holes punched out
DH, E8, FP, MS, PN, RH, RK, VG, VH, VJ, VK				
PD				

	VANITY UNIT	VANITY UNIT	VANITY UNIT	VANITY UNIT
				
Article number	B603 00 XX	B603 L0 XX	B604 00 XX	B604 L0 XX
Dimensions (w x h x d)	1000 x 380 x 500 mm	1000 x 380 x 500 mm	1000 x 550 x 500 mm	1000 x 550 x 500 mm
Version	washbasin on the middle	washbasin on the middle	washbasin on the middle	washbasin on the middle
For combination with	Memento 5133 6L, 5133 5L Memento 2.0 4A22 8F/8G/8L, 4A22 6F/6G/6L, 4A22 5F/5G/5L	Memento 5133 6L, 5133 5L Memento 2.0 4A22 6F/6G/6L Memento 2.0 4A22 8F/8G/8L Memento 2.0 4A22 5F/5G/5L	Memento 5133 6L, 5133 5L Memento 2.0 4A22 8F/8G/8L, 4A22 6F/6G/6L, 4A22 5F/5G/5L	Memento 5133 6L, 5133 5L Memento 2.0 4A22 5F/5G/5L Memento 2.0 4A22 6F/6G/6L Memento 2.0 4A22 8F/8G/8L
Lighting	-	LED lighting Lighting 1x LED / 24,8 W	-	LED lighting Lighting 1x LED / 24,8 W
Equipped with	1x Accessories package 1 1x pull-out compartment with non-slip mat	1x Accessories package 1 1x pull-out compartment with non-slip mat	1x Accessories package 1 2x pull-out compartment with non-slip mat	1x Accessories package 1 2x pull-out compartment with non-slip mat
Note on standard	-	IP 44	-	IP 44
Installation	wall-mounted	wall-mounted	wall-mounted	wall-mounted
Scope of delivery	fastening set included	fastening set included	fastening set included	fastening set included
Please note	no 3-hole tap fitting possible, tap holes punched out	no 3-hole tap fitting possible, tap holes punched out	no 3-hole tap fitting possible, tap holes punched out	no 3-hole tap fitting possible, tap holes punched out
DH, E8, FP, MS, PN, RH, RK, VG, VH, VJ, VK				
PD				









XX = Insert front and body colour
 DH = Glossy White, FP = Glossy Grey, MS = White Matt, PD = Black Matt
 Lacquer, VG = Truffle Grey, VK = Soft Grey, E8 = White Wood, PN = Elm
 Impresso, RH = Oak Kansas, RK = Stone Oak, VH = Arizona Oak, VJ =
 Nordic Oak

LEGATO

€ excl. VAT

Registered design

Produced to order (Please note that it is not always possible to cancel or change orders!), The washbasins are to be ordered separately.

	VANITY UNIT	VANITY UNIT	VANITY UNIT	VANITY UNIT
				
Article number	B605 00 XX	B605 L0 XX	B606 00 XX	B606 L0 XX
Dimensions (w x h x d)	1000 x 380 x 500 mm	1000 x 380 x 500 mm	1000 x 550 x 500 mm	1000 x 550 x 500 mm
Version	washbasin on left	washbasin on left	washbasin on left	washbasin on left
For combination with	Memento 5133 5L Memento 2.0 4A22 5F/5G/5L	Memento 5133 5L Memento 2.0 4A22 5F/5G/5L	Memento 5133 5L Memento 2.0 4A22 5F/5G/5L	Memento 5133 5L Memento 2.0 4A22 5F/5G/5L
Lighting	-	LED lighting Lighting 1x LED / 24,8 W	-	LED lighting Lighting 1x LED / 24,8 W
Equipped with	1x Accessories package 1 1x pull-out compartment with non-slip mat	1x Accessories package 1 1x pull-out compartment with non-slip mat	1x Accessories package 1 2x pull-out compartment with non-slip mat	1x Accessories package 1 2x pull-out compartment with non-slip mat
Note on standard	-	IP 44	-	IP 44
Installation	wall-mounted	wall-mounted	wall-mounted	wall-mounted
Scope of delivery	fastening set included	fastening set included	fastening set included	fastening set included
Please note	no 3-hole tap fitting possible, tap holes punched out	no 3-hole tap fitting possible, tap holes punched out	no 3-hole tap fitting possible, tap holes punched out	no 3-hole tap fitting possible, tap holes punched out
DH, E8, FP, MS, PN, RH, RK, VG, VH, VJ, VK				
PD				
	VANITY UNIT	VANITY UNIT	VANITY UNIT	VANITY UNIT
				
Article number	B607 00 XX	B607 L0 XX	B608 00 XX	B608 L0 XX
Dimensions (w x h x d)	1000 x 380 x 500 mm	1000 x 380 x 500 mm	1000 x 550 x 500 mm	1000 x 550 x 500 mm
Version	washbasin on right	washbasin on right	washbasin on right	washbasin on right
For combination with	Memento 5133 5L Memento 2.0 4A22 5F/5G/5L	Memento 5133 5L Memento 2.0 4A22 5F/5G/5L	Memento 5133 5L Memento 2.0 4A22 5F/5G/5L	Memento 5133 5L Memento 2.0 4A22 5F/5G/5L
Lighting	-	LED lighting Lighting 1x LED / 24,8 W	-	LED lighting Lighting 1x LED / 24,8 W
Equipped with	1x Accessories package 1 1x pull-out compartment with non-slip mat	1x Accessories package 1 1x pull-out compartment with non-slip mat	1x Accessories package 1 2x pull-out compartment with non-slip mat	1x Accessories package 1 2x pull-out compartment with non-slip mat
Note on standard	-	IP 44	-	IP 44
Installation	wall-mounted	wall-mounted	wall-mounted	wall-mounted
Scope of delivery	fastening set included	fastening set included	fastening set included	fastening set included
Please note	no 3-hole tap fitting possible, tap holes punched out	no 3-hole tap fitting possible, tap holes punched out	no 3-hole tap fitting possible, tap holes punched out	no 3-hole tap fitting possible, tap holes punched out
DH, E8, FP, MS, PN, RH, RK, VG, VH, VJ, VK				
PD				

LEGATO



XX = Insert front and body colour
 DH = Glossy White, FP = Glossy Grey, MS = White Matt, PD = Black Matt
 Lacquer, VG = Truffle Grey, VK = Soft Grey, E8 = White Wood, PN = Elm
 Impresso, RH = Oak Kansas, RK = Stone Oak, VH = Arizona Oak, VJ =
 Nordic Oak



LEGATO

€ excl. VAT

Registered design

Produced to order (Please note that it is not always possible to cancel or change orders!), The washbasins are to be ordered separately.

	VANITY UNIT	VANITY UNIT	VANITY UNIT	VANITY UNIT
				
Article number	B601 00 XX	B601 L0 XX	B602 00 XX	B602 L0 XX
Dimensions (w x h x d)	800 x 380 x 500 mm	800 x 380 x 500 mm	800 x 550 x 500 mm	800 x 550 x 500 mm
Version	washbasin on the middle	washbasin on the middle	washbasin on the middle	washbasin on the middle
For combination with	Memento 5133 6L, 5133 5L Memento 2.0 4A22 6F/6G/6L, 4A22 5F/5G/5L	Memento 5133 6L, 5133 5L Memento 2.0 4A22 6F/6G/6L, 4A22 5F/5G/5L	Memento 5133 6L, 5133 5L Memento 2.0 4A22 6F/6G/6L, 4A22 5F/5G/5L	Memento 5133 6L, 5133 5L Memento 2.0 4A22 6F/6G/6L, 4A22 5F/5G/5L
Lighting	-	LED lighting Lighting 1x LED / 21,6 W	-	LED lighting Lighting 1x LED / 21,6 W
Equipped with	1x Accessories package 1 1x pull-out compartment with non-slip mat	1x Accessories package 1 1x pull-out compartment with non-slip mat	1x Accessories package 1 2x pull-out compartment with non-slip mat	1x Accessories package 1 2x pull-out compartment with non-slip mat
Note on standard	-	IP 44	-	IP 44
Installation	wall-mounted	wall-mounted	wall-mounted	wall-mounted
Scope of delivery	fastening set included	fastening set included	fastening set included	fastening set included
Please note	no 3-hole tap fitting possible, tap holes punched out	no 3-hole tap fitting possible, tap holes punched out	no 3-hole tap fitting possible, tap holes punched out	no 3-hole tap fitting possible, tap holes punched out
DH, E8, FP, MS, PN, RH, RK, VG, VH, VJ, VK				
PD				

	VANITY UNIT	VANITY UNIT	VANITY UNIT	VANITY UNIT
				
Article number	B692 00 XX	B692 L0 XX	B693 00 XX	B693 L0 XX
Dimensions (w x h x d)	1600 x 380 x 500 mm	1600 x 380 x 500 mm	1600 x 550 x 500 mm	1600 x 550 x 500 mm
Version	for 2 washbasins	for 2 washbasins	for 2 washbasins	for 2 washbasins
For combination with	Finion 4168 6C/6L Subway 2.0 7113 6G, 7113 KG	Finion 4168 6C/6L Subway 2.0 7113 6G, 7113 KG	Finion 4168 6C/6L Subway 2.0 7113 6G, 7113 KG	Finion 4168 6C/6L Subway 2.0 7113 6G, 7113 KG
Lighting	-	LED lighting Lighting 1x LED / 34,1 W	-	LED lighting Lighting 1x LED / 34,1 W
Equipped with	2x Accessories package 1 2x pull-out compartment with non-slip mat	2x Accessories package 1 2x pull-out compartment with non-slip mat	2x Accessories package 1 4x pull-out compartment with non-slip mat	2x Accessories package 1 4x pull-out compartment with non-slip mat
Note on standard	-	IP 44	-	IP 44
Installation	wall-mounted	wall-mounted	wall-mounted	wall-mounted
Scope of delivery	fastening set included	fastening set included	fastening set included	fastening set included
Please note	no 3-hole tap fitting possible	no 3-hole tap fitting possible	no 3-hole tap fitting possible	no 3-hole tap fitting possible
DH, E8, FP, MS, PN, RH, RK, VG, VH, VJ, VK				
PD				

XX = Insert front and body colour





DH = Glossy White, FP = Glossy Grey, MS = White Matt, PD = Black Matt
Lacquer, VG = Truffle Grey, VK = Soft Grey, E8 = White Wood, PN = Elm
Impresso, RH = Oak Kansas, RK = Stone Oak, VH = Arizona Oak, VJ =
Nordic Oak





LEGATO

€ excl. VAT

Registered design

Produced to order (Please note that it is not always possible to cancel or change orders!), The washbasins are to be ordered separately.

	VANITY UNIT	VANITY UNIT	VANITY UNIT	VANITY UNIT
				
Article number	B686 00 XX	B686 L0 XX	B687 00 XX	B687 L0 XX
Dimensions (w x h x d)	1600 x 380 x 500 mm	1600 x 380 x 500 mm	1600 x 550 x 500 mm	1600 x 550 x 500 mm
Version	washbasin on the middle	washbasin on the middle	washbasin on the middle	washbasin on the middle
For combination with	Finion 4168 1B/1H/1L, 4168 8C/8L, 4168 6C/6L Subway 2.0 7113 6G, 7113 KG	Finion 4168 1B/1H/1L, 4168 8C/8L, 4168 6C/6L Subway 2.0 7113 6G, 7113 KG	Finion 4168 1B/1H/1L, 4168 8C/8L, 4168 6C/6L Subway 2.0 7113 6G, 7113 KG	Finion 4168 1B/1H/1L, 4168 8C/8L, 4168 6C/6L Subway 2.0 7113 6G, 7113 KG
Lighting	-	LED lighting Lighting 1x LED / 34,1 W	-	LED lighting Lighting 1x LED / 34,1 W
Equipped with	2x Accessories package 1 3x pull-out compartment with non-slip mat	2x Accessories package 1 3x pull-out compartment with non-slip mat	2x Accessories package 1 5x pull-out compartment with non-slip mat	2x Accessories package 1 5x pull-out compartment with non-slip mat
Note on standard	-	IP 44	-	IP 44
Installation	wall-mounted	wall-mounted	wall-mounted	wall-mounted
Scope of delivery	fastening set included	fastening set included	fastening set included	fastening set included
DH, E8, FP, MS, PN, RH, RK, VG, VH, VJ, VK				
PD				

	VANITY UNIT	VANITY UNIT	VANITY UNIT	VANITY UNIT
				
Article number	B700 00 XX	B700 L0 XX	B701 00 XX	B701 L0 XX
Dimensions (w x h x d)	1600 x 380 x 500 mm	1600 x 380 x 500 mm	1600 x 550 x 500 mm	1600 x 550 x 500 mm
Version	washbasin on the middle	washbasin on the middle	washbasin on the middle	washbasin on the middle
For combination with	Subway 2.0 7175 1G/8G	Subway 2.0 7175 1G/8G	Subway 2.0 7175 1G/8G	Subway 2.0 7175 1G/8G
Lighting	-	LED lighting Lighting 1x LED / 34,1 W	-	LED lighting Lighting 1x LED / 34,1 W
Equipped with	2x Accessories package 1 3x pull-out compartment with non-slip mat	2x Accessories package 1 3x pull-out compartment with non-slip mat	2x Accessories package 1 5x pull-out compartment with non-slip mat	2x Accessories package 1 5x pull-out compartment with non-slip mat
Note on standard	-	IP 44	-	IP 44
Installation	wall-mounted	wall-mounted	wall-mounted	wall-mounted
Scope of delivery	fastening set included	fastening set included	fastening set included	fastening set included
DH, E8, FP, MS, PN, RH, RK, VG, VH, VJ, VK				
PD				





XX = Insert front and body colour
 DH = Glossy White, FP = Glossy Grey, MS = White Matt, PD = Black Matt
 Lacquer, VG = Truffle Grey, VK = Soft Grey, E8 = White Wood, PN = Elm
 Impreso, RH = Oak Kansas, RK = Stone Oak, VH = Arizona Oak, VJ =
 Nordic Oak

LEGATO

€ excl. VAT

Registered design

Produced to order (Please note that it is not always possible to cancel or change orders!), The washbasins are to be ordered separately.

	VANITY UNIT	VANITY UNIT	VANITY UNIT	VANITY UNIT
				
Article number	B688 00 XX	B688 L0 XX	B689 00 XX	B689 L0 XX
Dimensions (w x h x d)	1600 x 380 x 500 mm	1600 x 380 x 500 mm	1600 x 550 x 500 mm	1600 x 550 x 500 mm
Version	washbasin on left	washbasin on left	washbasin on left	washbasin on left
For combination with	Finion 4168 6C/6L Subway 2.0 7113 6G, 7113 KG	Finion 4168 6C/6L Subway 2.0 7113 6G, 7113 KG	Finion 4168 6C/6L Subway 2.0 7113 6G, 7113 KG	Finion 4168 6C/6L Subway 2.0 7113 6G, 7113 KG
Lighting	-	LED lighting Lighting 1x LED / 34,1 W	-	LED lighting Lighting 1x LED / 34,1 W
Equipped with	2x Accessories package 1 2x pull-out compartment with non-slip mat	2x Accessories package 1 2x pull-out compartment with non-slip mat	2x Accessories package 1 4x pull-out compartment with non-slip mat	2x Accessories package 1 4x pull-out compartment with non-slip mat
Note on standard	-	IP 44	-	IP 44
Installation	wall-mounted	wall-mounted	wall-mounted	wall-mounted
Scope of delivery	fastening set included	fastening set included	fastening set included	fastening set included
Please note	no 3-hole tap fitting possible	no 3-hole tap fitting possible	no 3-hole tap fitting possible	no 3-hole tap fitting possible
DH, E8, FP, MS, PN, RH, RK, VG, VH, VJ, VK				
PD				
	VANITY UNIT	VANITY UNIT	VANITY UNIT	VANITY UNIT
				
Article number	B690 00 XX	B690 L0 XX	B691 00 XX	B691 L0 XX
Dimensions (w x h x d)	1600 x 380 x 500 mm	1600 x 380 x 500 mm	1600 x 550 x 500 mm	1600 x 550 x 500 mm
Version	washbasin on right	washbasin on right	washbasin on right	washbasin on right
For combination with	Finion 4168 6C/6L Subway 2.0 7113 6G, 7113 KG	Finion 4168 6C/6L Subway 2.0 7113 6G, 7113 KG	Finion 4168 6C/6L Subway 2.0 7113 6G, 7113 KG	Finion 4168 6C/6L Subway 2.0 7113 6G, 7113 KG
Lighting	-	LED lighting Lighting 1x LED / 34,1 W	-	LED lighting Lighting 1x LED / 34,1 W
Equipped with	2x Accessories package 1 2x pull-out compartment with non-slip mat	2x Accessories package 1 2x pull-out compartment with non-slip mat	2x Accessories package 1 4x pull-out compartment with non-slip mat	2x Accessories package 1 4x pull-out compartment with non-slip mat
Note on standard	-	IP 44	-	IP 44
Installation	wall-mounted	wall-mounted	wall-mounted	wall-mounted
Scope of delivery	fastening set included	fastening set included	fastening set included	fastening set included
Please note	no 3-hole tap fitting possible	no 3-hole tap fitting possible	no 3-hole tap fitting possible	no 3-hole tap fitting possible
DH, E8, FP, MS, PN, RH, RK, VG, VH, VJ, VK				
PD				

LEGATO





XX = Insert front and body colour
 DH = Glossy White, FP = Glossy Grey, MS = White Matt, PD = Black Matt
 Lacquer, VG = Truffle Grey, VK = Soft Grey, E8 = White Wood, PN = Elm
 Impresso, RH = Oak Kansas, RK = Stone Oak, VH = Arizona Oak, VJ =
 Nordic Oak





LEGATO

€ excl. VAT

Registered design

Produced to order (Please note that it is not always possible to cancel or change orders!), The washbasins are to be ordered separately.

	VANITY UNIT	VANITY UNIT	VANITY UNIT	VANITY UNIT
				
Article number	B684 00 XX	B684 L0 XX	B685 00 XX	B685 L0 XX
Dimensions (w x h x d)	1400 x 380 x 500 mm	1400 x 380 x 500 mm	1400 x 550 x 500 mm	1400 x 550 x 500 mm
Version	washbasin on the middle	washbasin on the middle	washbasin on the middle	washbasin on the middle
For combination with	Finion 4168 1B/1H/1L, 4168 8C/8L, 4168 6C/6L Subway 2.0 7113 6G, 7113 KG	Finion 4168 1B/1H/1L, 4168 8C/8L, 4168 6C/6L Subway 2.0 7113 6G, 7113 KG	Finion 4168 1B/1H/1L, 4168 8C/8L, 4168 6C/6L Subway 2.0 7113 6G, 7113 KG	Finion 4168 1B/1H/1L, 4168 8C/8L, 4168 6C/6L Subway 2.0 7113 6G, 7113 KG
Lighting	-	LED lighting Lighting 1x LED / 31 W	-	LED lighting Lighting 1x LED / 31 W
Equipped with	2x Accessories package 1 3x pull-out compartment with non-slip mat	2x Accessories package 1 3x pull-out compartment with non-slip mat	2x Accessories package 1 5x pull-out compartment with non-slip mat	2x Accessories package 1 5x pull-out compartment with non-slip mat
Note on standard	-	IP 44	-	IP 44
Installation	wall-mounted	wall-mounted	wall-mounted	wall-mounted
Scope of delivery	fastening set included	fastening set included	fastening set included	fastening set included
DH, E8, FP, MS, PN, RH, RK, VG, VH, VJ, VK				
PD				

	VANITY UNIT	VANITY UNIT	VANITY UNIT	VANITY UNIT
				
Article number	B698 00 XX	B698 L0 XX	B699 00 XX	B699 L0 XX
Dimensions (w x h x d)	1400 x 380 x 500 mm	1400 x 380 x 500 mm	1400 x 550 x 500 mm	1400 x 550 x 500 mm
Version	washbasin on the middle	washbasin on the middle	washbasin on the middle	washbasin on the middle
For combination with	Subway 2.0 7175 1G/8G	Subway 2.0 7175 1G/8G	Subway 2.0 7175 1G/8G	Subway 2.0 7175 1G/8G
Lighting	-	LED lighting Lighting 1x LED / 31 W	-	LED lighting Lighting 1x LED / 31 W
Equipped with	2x Accessories package 1 3x pull-out compartment with non-slip mat	2x Accessories package 1 3x pull-out compartment with non-slip mat	2x Accessories package 1 5x pull-out compartment with non-slip mat	2x Accessories package 1 5x pull-out compartment with non-slip mat
Note on standard	-	IP 44	-	IP 44
Installation	wall-mounted	wall-mounted	wall-mounted	wall-mounted
Scope of delivery	fastening set included	fastening set included	fastening set included	fastening set included
DH, E8, FP, MS, PN, RH, RK, VG, VH, VJ, VK				
PD				

LEGATO

XX = Insert front and body colour









DH = Glossy White, FP = Glossy Grey, MS = White Matt, PD = Black Matt
Lacquer, VG = Truffle Grey, VK = Soft Grey, E8 = White Wood, PN = Elm
Impresso, RH = Oak Kansas, RK = Stone Oak, VH = Arizona Oak, VJ =
Nordic Oak

LEGATO

€ excl. VAT

Registered design

Produced to order (Please note that it is not always possible to cancel or change orders!), The washbasins are to be ordered separately.

	VANITY UNIT	VANITY UNIT	VANITY UNIT	VANITY UNIT
				
Article number	B682 00 XX	B682 L0 XX	B683 00 XX	B683 L0 XX
Dimensions (w x h x d)	1200 x 380 x 500 mm	1200 x 380 x 500 mm	1200 x 550 x 500 mm	1200 x 550 x 500 mm
Version	washbasin on the middle	washbasin on the middle	washbasin on the middle	washbasin on the middle
For combination with	Finion 4168 1B/1H/1L, 4168 8C/8L, 4168 6C/6L Subway 2.0 7113 6G, 7113 KG	Finion 4168 1B/1H/1L, 4168 8C/8L, 4168 6C/6L Subway 2.0 7113 6G, 7113 KG	Finion 4168 1B/1H/1L, 4168 8C/8L, 4168 6C/6L Subway 2.0 7113 6G, 7113 KG	Finion 4168 1B/1H/1L, 4168 8C/8L, 4168 6C/6L Subway 2.0 7113 6G, 7113 KG
Lighting	-	LED lighting Lighting 1x LED / 27,9 W	-	LED lighting Lighting 1x LED / 27,9 W
Equipped with	1x Accessories package 1 3x pull-out compartment with non-slip mat	1x Accessories package 1 3x pull-out compartment with non-slip mat	1x Accessories package 1 5x pull-out compartment with non-slip mat	1x Accessories package 1 5x pull-out compartment with non-slip mat
Note on standard	-	IP 44	-	IP 44
Installation	wall-mounted	wall-mounted	wall-mounted	wall-mounted
Scope of delivery	fastening set included	fastening set included	fastening set included	fastening set included
DH, E8, FP, MS, PN, RH, RK, VG, VH, VJ, VK				
PD				
	VANITY UNIT	VANITY UNIT	VANITY UNIT	VANITY UNIT
				
Article number	B696 00 XX	B696 L0 XX	B697 00 XX	B697 L0 XX
Dimensions (w x h x d)	1200 x 380 x 500 mm	1200 x 380 x 500 mm	1200 x 550 x 500 mm	1200 x 550 x 500 mm
Version	washbasin on the middle	washbasin on the middle	washbasin on the middle	washbasin on the middle
For combination with	Subway 2.0 7175 1G/8G	Subway 2.0 7175 1G/8G	Subway 2.0 7175 1G/8G	Subway 2.0 7175 1G/8G
Lighting	-	LED lighting Lighting 1x LED / 27,9 W	-	LED lighting Lighting 1x LED / 27,9 W
Equipped with	1x Accessories package 1 3x pull-out compartment with non-slip mat	1x Accessories package 1 3x pull-out compartment with non-slip mat	1x Accessories package 1 5x pull-out compartment with non-slip mat	1x Accessories package 1 5x pull-out compartment with non-slip mat
Note on standard	-	IP 44	-	IP 44
Installation	wall-mounted	wall-mounted	wall-mounted	wall-mounted
Scope of delivery	fastening set included	fastening set included	fastening set included	fastening set included
DH, E8, FP, MS, PN, RH, RK, VG, VH, VJ, VK				
PD				





XX = Insert front and body colour
 DH = Glossy White, FP = Glossy Grey, MS = White Matt, PD = Black Matt
 Lacquer, VG = Truffle Grey, VK = Soft Grey, E8 = White Wood, PN = Elm
 Impreso, RH = Oak Kansas, RK = Stone Oak, VH = Arizona Oak, VJ =
 Nordic Oak





LEGATO

€ excl. VAT

Registered design

Produced to order (Please note that it is not always possible to cancel or change orders!), The washbasins are to be ordered separately.

	VANITY UNIT	VANITY UNIT	VANITY UNIT	VANITY UNIT
				
Article number	B694 00 XX	B694 L0 XX	B695 00 XX	B695 L0 XX
Dimensions (w x h x d)	1000 x 380 x 500 mm	1000 x 380 x 500 mm	1000 x 550 x 500 mm	1000 x 550 x 500 mm
Version	washbasin on the middle	washbasin on the middle	washbasin on the middle	washbasin on the middle
For combination with	Subway 2.0 7175 8G	Subway 2.0 7175 8G	Subway 2.0 7175 8G	Subway 2.0 7175 8G
Lighting	-	LED lighting Lighting 1x LED / 24,8 W	-	LED lighting Lighting 1x LED / 24,8 W
Equipped with	1x Accessories package 1 1x pull-out compartment with non-slip mat	1x Accessories package 1 1x pull-out compartment with non-slip mat	1x Accessories package 1 2x pull-out compartment with non-slip mat	1x Accessories package 1 2x pull-out compartment with non-slip mat
Note on standard	-	IP 44	-	IP 44
Installation	wall-mounted	wall-mounted	wall-mounted	wall-mounted
Scope of delivery	fastening set included	fastening set included	fastening set included	fastening set included
Please note	no 3-hole tap fitting possible	no 3-hole tap fitting possible	no 3-hole tap fitting possible	no 3-hole tap fitting possible
DH, E8, FP, MS, PN, RH, RK, VG, VH, VJ, VK				
PD				

	VANITY UNIT	VANITY UNIT	VANITY UNIT	VANITY UNIT
				
Article number	B680 00 XX	B680 L0 XX	B681 00 XX	B681 L0 XX
Dimensions (w x h x d)	1000 x 380 x 500 mm	1000 x 380 x 500 mm	1000 x 550 x 500 mm	1000 x 550 x 500 mm
Version	washbasin on the middle	washbasin on the middle	washbasin on the middle	washbasin on the middle
For combination with	Finion 4168 8C/8L, 4168 6C/6L Subway 2.0 7113 6G, 7113 KG	Finion 4168 8C/8L, 4168 6C/6L Subway 2.0 7113 6G, 7113 KG	Finion 4168 8C/8L, 4168 6C/6L Subway 2.0 7113 6G, 7113 KG	Subway 2.0 7113 6G, 7113 KG Finion 4168 8C/8L, 4168 6C/6L
Lighting	-	LED lighting Lighting 1x LED / 24,8 W	-	LED lighting Lighting 1x LED / 24,8 W
Equipped with	1x Accessories package 1 1x pull-out compartment with non-slip mat	1x Accessories package 1 1x pull-out compartment with non-slip mat	1x Accessories package 1 2x pull-out compartment with non-slip mat	1x Accessories package 1 2x pull-out compartment with non-slip mat
Note on standard	-	IP 44	-	IP 44
Installation	wall-mounted	wall-mounted	wall-mounted	wall-mounted
Scope of delivery	fastening set included	fastening set included	fastening set included	fastening set included
Please note	no 3-hole tap fitting possible	no 3-hole tap fitting possible	no 3-hole tap fitting possible	no 3-hole tap fitting possible
DH, E8, FP, MS, PN, RH, RK, VG, VH, VJ, VK				
PD				

XX = Insert front and body colour
 DH = Glossy White, FP = Glossy Grey, MS = White Matt, PD = Black Matt
 Lacquer, VG = Truffle Grey, VK = Soft Grey, E8 = White Wood, PN = Elm
 Impresso, RH = Oak Kansas, RK = Stone Oak, VH = Arizona Oak, VJ =
 Nordic Oak





LEGATO





LEGATO

€ excl. VAT

Registered design

Produced to order (Please note that it is not always possible to cancel or change orders!), The washbasins are to be ordered separately.

	VANITY UNIT	VANITY UNIT	VANITY UNIT	VANITY UNIT
				
Article number	B678 00 XX	B678 L0 XX	B679 00 XX	B679 L0 XX
Dimensions (w x h x d)	800 x 380 x 500 mm	800 x 380 x 500 mm	800 x 550 x 500 mm	800 x 550 x 500 mm
Version	washbasin on the middle	washbasin on the middle	washbasin on the middle	washbasin on the middle
For combination with	Finion 4168 6C/6L Subway 2.0 7113 6G, 7113 KG	Finion 4168 6C/6L Subway 2.0 7113 6G, 7113 KG	Finion 4168 6C/6L Subway 2.0 7113 6G, 7113 KG	Finion 4168 6C/6L Subway 2.0 7113 6G, 7113 KG
Lighting	-	LED lighting Lighting 1x LED / 21,6 W	-	LED lighting Lighting 1x LED / 21,6 W
Equipped with	1x Accessories package 1 1x pull-out compartment with non-slip mat	1x Accessories package 1 1x pull-out compartment with non-slip mat	1x Accessories package 1 2x pull-out compartment with non-slip mat	1x Accessories package 1 2x pull-out compartment with non-slip mat
Note on standard	-	IP 44	-	IP 44
Installation	wall-mounted	wall-mounted	wall-mounted	wall-mounted
Scope of delivery	fastening set included	fastening set included	fastening set included	fastening set included
Please note	no 3-hole tap fitting possible	no 3-hole tap fitting possible	no 3-hole tap fitting possible	no 3-hole tap fitting possible
DH, E8, FP, MS, PN, RH, RK, VG, VH, VJ, VK				
PD				

	VANITY UNIT	VANITY UNIT	VANITY UNIT	VANITY UNIT
				
Article number	B751 00 XX	B751 L0 XX	B752 00 XX	B752 L0 XX
Dimensions (w x h x d)	1600 x 380 x 500 mm	1600 x 380 x 500 mm	1600 x 550 x 500 mm	1600 x 550 x 500 mm
Version	for 2 washbasins	for 2 washbasins	for 2 washbasins	for 2 washbasins
For combination with	Finion 4143 61	Finion 4143 61	Finion 4143 61	Finion 4143 61
Lighting	-	LED lighting Lighting 1x LED / 34,1 W	-	LED lighting Lighting 1x LED / 34,1 W
Equipped with	2x Accessories package 1 2x pull-out compartment with non-slip mat	2x Accessories package 1 2x pull-out compartment with non-slip mat	2x Accessories package 1 4x pull-out compartment with non-slip mat	2x Accessories package 1 4x pull-out compartment with non-slip mat
Note on standard	-	IP 44	-	IP 44
Installation	wall-mounted	wall-mounted	wall-mounted	wall-mounted
Scope of delivery	fastening set included	fastening set included	fastening set included	fastening set included
DH, E8, FP, MS, PN, RH, RK, VG, VH, VJ, VK				
PD				









XX = Insert front and body colour
 DH = Glossy White, FP = Glossy Grey, MS = White Matt, PD = Black Matt
 Lacquer, VG = Truffle Grey, VK = Soft Grey, E8 = White Wood, PN = Elm
 Impresso, RH = Oak Kansas, RK = Stone Oak, VH = Arizona Oak, VJ =
 Nordic Oak

LEGATO

€ excl. VAT

Registered design

Produced to order (Please note that it is not always possible to cancel or change orders!), The washbasins are to be ordered separately.

	VANITY UNIT	VANITY UNIT	VANITY UNIT	VANITY UNIT
				
Article number	B745 00 XX	B745 L0 XX	B746 00 XX	B746 L0 XX
Dimensions (w x h x d)	1600 x 380 x 500 mm	1600 x 380 x 500 mm	1600 x 550 x 500 mm	1600 x 550 x 500 mm
Version	washbasin on the middle	washbasin on the middle	washbasin on the middle	washbasin on the middle
For combination with	Finion 4143 61	Finion 4143 61	Finion 4143 61	Finion 4143 61
Lighting	-	LED lighting Lighting 1x LED / 34,1 W	-	LED lighting Lighting 1x LED / 34,1 W
Equipped with	2x Accessories package 1 3x pull-out compartment with non-slip mat	2x Accessories package 1 3x pull-out compartment with non-slip mat	2x Accessories package 1 5x pull-out compartment with non-slip mat	2x Accessories package 1 5x pull-out compartment with non-slip mat
Note on standard	-	IP 44	-	IP 44
Installation	wall-mounted	wall-mounted	wall-mounted	wall-mounted
Scope of delivery	fastening set included	fastening set included	fastening set included	fastening set included
DH, E8, FP, MS, PN, RH, RK, VG, VH, VJ, VK				
PD				
	VANITY UNIT	VANITY UNIT	VANITY UNIT	VANITY UNIT
				
Article number	B747 00 XX	B747 L0 XX	B748 00 XX	B748 L0 XX
Dimensions (w x h x d)	1600 x 380 x 500 mm	1600 x 380 x 500 mm	1600 x 550 x 500 mm	1600 x 550 x 500 mm
Version	washbasin on left	washbasin on left	washbasin on left	washbasin on left
For combination with	Finion 4143 61	Finion 4143 61	Finion 4143 61	Finion 4143 61
Lighting	-	LED lighting Lighting 1x LED / 34,1 W	-	LED lighting Lighting 1x LED / 34,1 W
Equipped with	2x Accessories package 1 2x pull-out compartment with non-slip mat	2x Accessories package 1 2x pull-out compartment with non-slip mat	2x Accessories package 1 4x pull-out compartment with non-slip mat	2x Accessories package 1 4x pull-out compartment with non-slip mat
Note on standard	-	IP 44	-	IP 44
Installation	wall-mounted	wall-mounted	wall-mounted	wall-mounted
Scope of delivery	fastening set included	fastening set included	fastening set included	fastening set included
DH, E8, FP, MS, PN, RH, RK, VG, VH, VJ, VK				
PD				

LEGATO

XX = Insert front and body colour









DH = Glossy White, FP = Glossy Grey, MS = White Matt, PD = Black Matt
 Lacquer, VG = Truffle Grey, VK = Soft Grey, E8 = White Wood, PN = Elm
 Impresso, RH = Oak Kansas, RK = Stone Oak, VH = Arizona Oak, VJ =
 Nordic Oak

LEGATO

€ excl. VAT

Registered design

Produced to order (Please note that it is not always possible to cancel or change orders!), The washbasins are to be ordered separately.

	VANITY UNIT	VANITY UNIT	VANITY UNIT	VANITY UNIT
				
Article number	B749 00 XX	B749 L0 XX	B750 00 XX	B750 L0 XX
Dimensions (w x h x d)	1600 x 380 x 500 mm	1600 x 380 x 500 mm	1600 x 550 x 500 mm	1600 x 550 x 500 mm
Version	washbasin on right	washbasin on right	washbasin on right	washbasin on right
For combination with	Finion 4143 61	Finion 4143 61	Finion 4143 61	Finion 4143 61
Lighting	-	LED lighting Lighting 1x LED / 34,1 W	-	LED lighting Lighting 1x LED / 34,1 W
Equipped with	2x Accessories package 1 2x pull-out compartment with non-slip mat	2x Accessories package 1 2x pull-out compartment with non-slip mat	2x Accessories package 1 4x pull-out compartment with non-slip mat	2x Accessories package 1 4x pull-out compartment with non-slip mat
Note on standard	-	IP 44	-	IP 44
Installation	wall-mounted	wall-mounted	wall-mounted	wall-mounted
Scope of delivery	fastening set included	fastening set included	fastening set included	fastening set included
DH, E8, FP, MS, PN, RH, RK, VG, VH, VJ, VK				
PD				
	VANITY UNIT	VANITY UNIT	VANITY UNIT	VANITY UNIT
				
Article number	B743 00 XX	B743 L0 XX	B744 00 XX	B744 L0 XX
Dimensions (w x h x d)	1400 x 380 x 500 mm	1400 x 380 x 500 mm	1400 x 550 x 500 mm	1400 x 550 x 500 mm
Version	washbasin on the middle	washbasin on the middle	washbasin on the middle	washbasin on the middle
For combination with	Finion 4143 61	Finion 4143 61	Finion 4143 61	Finion 4143 61
Lighting	-	LED lighting Lighting 1x LED / 31 W	-	LED lighting Lighting 1x LED / 31 W
Equipped with	2x Accessories package 1 3x pull-out compartment with non-slip mat	2x Accessories package 1 3x pull-out compartment with non-slip mat	2x Accessories package 1 5x pull-out compartment with non-slip mat	2x Accessories package 1 5x pull-out compartment with non-slip mat
Note on standard	-	IP 44	-	IP 44
Installation	wall-mounted	wall-mounted	wall-mounted	wall-mounted
Scope of delivery	fastening set included	fastening set included	fastening set included	fastening set included
DH, E8, FP, MS, PN, RH, RK, VG, VH, VJ, VK				
PD				









XX = Insert front and body colour
 DH = Glossy White, FP = Glossy Grey, MS = White Matt, PD = Black Matt
 Lacquer, VG = Truffle Grey, VK = Soft Grey, E8 = White Wood, PN = Elm
 Impreso, RH = Oak Kansas, RK = Stone Oak, VH = Arizona Oak, VJ =
 Nordic Oak

LEGATO

€ excl. VAT

Registered design

Produced to order (Please note that it is not always possible to cancel or change orders!), The washbasins are to be ordered separately.

	VANITY UNIT	VANITY UNIT	VANITY UNIT	VANITY UNIT
				
Article number	B741 00 XX	B741 L0 XX	B742 00 XX	B742 L0 XX
Dimensions (w x h x d)	1200 x 380 x 500 mm	1200 x 380 x 500 mm	1200 x 550 x 500 mm	1200 x 550 x 500 mm
Version	washbasin on the middle	washbasin on the middle	washbasin on the middle	washbasin on the middle
For combination with	Finion 4143 61	Finion 4143 61	Finion 4143 61	Finion 4143 61
Lighting	-	LED lighting Lighting 1x LED / 27,9 W	-	LED lighting Lighting 1x LED / 27,9 W
Equipped with	1x Accessories package 1 3x pull-out compartment with non-slip mat	1x Accessories package 1 3x pull-out compartment with non-slip mat	1x Accessories package 1 5x pull-out compartment with non-slip mat	1x Accessories package 1 5x pull-out compartment with non-slip mat
Note on standard	-	IP 44	-	IP 44
Installation	wall-mounted	wall-mounted	wall-mounted	wall-mounted
Scope of delivery	fastening set included	fastening set included	fastening set included	fastening set included
DH, E8, FP, MS, PN, RH, RK, VG, VH, VJ, VK				
PD				
	VANITY UNIT	VANITY UNIT	VANITY UNIT	VANITY UNIT
				
Article number	B739 00 XX	B739 L0 XX	B740 00 XX	B740 L0 XX
Dimensions (w x h x d)	1000 x 380 x 500 mm	1000 x 380 x 500 mm	1000 x 550 x 500 mm	1000 x 550 x 500 mm
Version	washbasin on the middle	washbasin on the middle	washbasin on the middle	washbasin on the middle
For combination with	Finion 4143 61	Finion 4143 61	Finion 4143 61	Finion 4143 61
Lighting	-	LED lighting Lighting 1x LED / 24,8 W	-	LED lighting Lighting 1x LED / 24,8 W
Equipped with	1x Accessories package 1 1x pull-out compartment with non-slip mat	1x Accessories package 1 1x pull-out compartment with non-slip mat	1x Accessories package 1 2x pull-out compartment with non-slip mat	1x Accessories package 1 2x pull-out compartment with non-slip mat
Note on standard	-	IP 44	-	IP 44
Installation	wall-mounted	wall-mounted	wall-mounted	wall-mounted
Scope of delivery	fastening set included	fastening set included	fastening set included	fastening set included
DH, E8, FP, MS, PN, RH, RK, VG, VH, VJ, VK				
PD				

LEGATO

XX = Insert front and body colour





DH = Glossy White, FP = Glossy Grey, MS = White Matt, PD = Black Matt
 Lacquer, VG = Truffle Grey, VK = Soft Grey, E8 = White Wood, PN = Elm
 Impresso, RH = Oak Kansas, RK = Stone Oak, VH = Arizona Oak, VJ =
 Nordic Oak

LEGATO

€ excl. VAT

Registered design

Produced to order (Please note that it is not always possible to cancel or change orders!), The washbasins are to be ordered separately.

	VANITY UNIT	VANITY UNIT	VANITY UNIT	VANITY UNIT
				
Article number	B737 00 XX	B737 L0 XX	B738 00 XX	B738 L0 XX
Dimensions (w x h x d)	800 x 380 x 500 mm	800 x 380 x 500 mm	800 x 550 x 500 mm	800 x 550 x 500 mm
Version	washbasin on the middle	washbasin on the middle	washbasin on the middle	washbasin on the middle
For combination with	Finion 4143 61	Finion 4143 61	Finion 4143 61	Finion 4143 61
Lighting	-	LED lighting Lighting 1x LED / 21,6 W	-	LED lighting Lighting 1x LED / 21,6 W
Equipped with	1x Accessories package 1 1x pull-out compartment with non-slip mat	1x Accessories package 1 1x pull-out compartment with non-slip mat	1x Accessories package 1 2x pull-out compartment with non-slip mat	1x Accessories package 1 2x pull-out compartment with non-slip mat
Note on standard	-	IP 44	-	IP 44
Installation	wall-mounted	wall-mounted	wall-mounted	wall-mounted
Scope of delivery	fastening set included	fastening set included	fastening set included	fastening set included
DH, E8, FP, MS, PN, RH, RK, VG, VH, VJ, VK				
PD				
	VANITY UNIT	VANITY UNIT	VANITY UNIT	VANITY UNIT
				
Article number	B767 00 XX	B767 L0 XX	B768 00 XX	B768 L0 XX
Dimensions (w x h x d)	1600 x 380 x 500 mm	1600 x 380 x 500 mm	1600 x 550 x 500 mm	1600 x 550 x 500 mm
Version	for 2 washbasins	for 2 washbasins	for 2 washbasins	for 2 washbasins
For combination with	Finion 4142 61/64 Memento 2.0 4A07 60/61	Finion 4142 61/64 Memento 2.0 4A07 60/61	Finion 4142 61/64 Memento 2.0 4A07 60/61	Finion 4142 61/64 Memento 2.0 4A07 60/61
Lighting	-	LED lighting Lighting 1x LED / 34,1 W	-	LED lighting Lighting 1x LED / 34,1 W
Equipped with	2x Accessories package 1 2x pull-out compartment with non-slip mat	2x Accessories package 1 2x pull-out compartment with non-slip mat	2x Accessories package 1 4x pull-out compartment with non-slip mat	2x Accessories package 1 4x pull-out compartment with non-slip mat
Note on standard	-	IP 44	-	IP 44
Installation	wall-mounted	wall-mounted	wall-mounted	wall-mounted
Scope of delivery	fastening set included	fastening set included	fastening set included	fastening set included
DH, E8, FP, MS, PN, RH, RK, VG, VH, VJ, VK				
PD				





XX = Insert front and body colour
 DH = Glossy White, FP = Glossy Grey, MS = White Matt, PD = Black Matt
 Lacquer, VG = Truffle Grey, VK = Soft Grey, E8 = White Wood, PN = Elm
 Impresso, RH = Oak Kansas, RK = Stone Oak, VH = Arizona Oak, VJ =
 Nordic Oak





LEGATO

€ excl. VAT

Registered design

Produced to order (Please note that it is not always possible to cancel or change orders!), The washbasins are to be ordered separately.

	VANITY UNIT	VANITY UNIT	VANITY UNIT	VANITY UNIT
				
Article number	B761 00 XX	B761 L0 XX	B762 00 XX	B762 L0 XX
Dimensions (w x h x d)	1600 x 380 x 500 mm	1600 x 380 x 500 mm	1600 x 550 x 500 mm	1600 x 550 x 500 mm
Version	washbasin on the middle	washbasin on the middle	washbasin on the middle	washbasin on the middle
For combination with	Finion 4142 61/64 Memento 2.0 4A07 60/61	Finion 4142 61/64 Memento 2.0 4A07 60/61	Finion 4142 61/64 Memento 2.0 4A07 60/61	Finion 4142 61/64 Memento 2.0 4A07 60/61
Lighting	-	LED lighting Lighting 1x LED / 34,1 W	-	LED lighting Lighting 1x LED / 34,1 W
Equipped with	2x Accessories package 1 3x pull-out compartment with non-slip mat	2x Accessories package 1 3x pull-out compartment with non-slip mat	2x Accessories package 1 5x pull-out compartment with non-slip mat	2x Accessories package 1 5x pull-out compartment with non-slip mat
Note on standard	-	IP 44	-	IP 44
Installation	wall-mounted	wall-mounted	wall-mounted	wall-mounted
Scope of delivery	fastening set included	fastening set included	fastening set included	fastening set included
DH, E8, FP, MS, PN, RH, RK, VG, VH, VJ, VK				
PD				

	VANITY UNIT	VANITY UNIT	VANITY UNIT	VANITY UNIT
				
Article number	B763 00 XX	B763 L0 XX	B764 00 XX	B764 L0 XX
Dimensions (w x h x d)	1600 x 380 x 500 mm	1600 x 380 x 500 mm	1600 x 550 x 500 mm	1600 x 550 x 500 mm
Version	washbasin on left	washbasin on left	washbasin on left	washbasin on left
For combination with	Finion 4142 61/64 Memento 2.0 4A07 60/61	Finion 4142 61/64 Memento 2.0 4A07 60/61	Finion 4142 61/64 Memento 2.0 4A07 60/61	Finion 4142 61/64 Memento 2.0 4A07 60/61
Lighting	-	LED lighting Lighting 1x LED / 34,1 W	-	LED lighting Lighting 1x LED / 34,1 W
Equipped with	2x Accessories package 1 2x pull-out compartment with non-slip mat	2x Accessories package 1 2x pull-out compartment with non-slip mat	2x Accessories package 1 4x pull-out compartment with non-slip mat	2x Accessories package 1 4x pull-out compartment with non-slip mat
Note on standard	-	IP 44	-	IP 44
Installation	wall-mounted	wall-mounted	wall-mounted	wall-mounted
Scope of delivery	fastening set included	fastening set included	fastening set included	fastening set included
DH, E8, FP, MS, PN, RH, RK, VG, VH, VJ, VK				
PD				

XX = Insert front and body colour
 DH = Glossy White, FP = Glossy Grey, MS = White Matt, PD = Black Matt
 Lacquer, VG = Truffle Grey, VK = Soft Grey, E8 = White Wood, PN = Elm
 Impreso, RH = Oak Kansas, RK = Stone Oak, VH = Arizona Oak, VJ =
 Nordic Oak









LEGATO

LEGATO

€ excl. VAT

Registered design

Produced to order (Please note that it is not always possible to cancel or change orders!), The washbasins are to be ordered separately.

	VANITY UNIT	VANITY UNIT	VANITY UNIT	VANITY UNIT
				
Article number	B765 00 XX	B765 L0 XX	B766 00 XX	B766 L0 XX
Dimensions (w x h x d)	1600 x 380 x 500 mm	1600 x 380 x 500 mm	1600 x 550 x 500 mm	1600 x 550 x 500 mm
Version	washbasin on right	washbasin on right	washbasin on right	washbasin on right
For combination with	Finion 4142 61/64 Memento 2.0 4A07 60/61	Finion 4142 61/64 Memento 2.0 4A07 60/61	Finion 4142 61/64 Memento 2.0 4A07 60/61	Finion 4142 61/64 Memento 2.0 4A07 60/61
Lighting	-	LED lighting Lighting 1x LED / 34,1 W	-	LED lighting Lighting 1x LED / 34,1 W
Equipped with	2x Accessories package 1 2x pull-out compartment with non-slip mat	2x Accessories package 1 2x pull-out compartment with non-slip mat	2x Accessories package 1 4x pull-out compartment with non-slip mat	2x Accessories package 1 4x pull-out compartment with non-slip mat
Note on standard	-	IP 44	-	IP 44
Installation	wall-mounted	wall-mounted	wall-mounted	wall-mounted
Scope of delivery	fastening set included	fastening set included	fastening set included	fastening set included
DH, E8, FP, MS, PN, RH, RK, VG, VH, VJ, VK				
PD				
	VANITY UNIT	VANITY UNIT	VANITY UNIT	VANITY UNIT
				
Article number	B759 00 XX	B759 L0 XX	B760 00 XX	B760 L0 XX
Dimensions (w x h x d)	1400 x 380 x 500 mm	1400 x 380 x 500 mm	1400 x 550 x 500 mm	1400 x 550 x 500 mm
Version	washbasin on the middle	washbasin on the middle	washbasin on the middle	washbasin on the middle
For combination with	Finion 4142 61/64 Memento 2.0 4A07 60/61	Finion 4142 61/64 Memento 2.0 4A07 60/61	Finion 4142 61/64 Memento 2.0 4A07 60/61	Finion 4142 61/64 Memento 2.0 4A07 60/61
Lighting	-	LED lighting Lighting 1x LED / 31 W	-	LED lighting Lighting 1x LED / 31 W
Equipped with	2x Accessories package 1 3x pull-out compartment with non-slip mat	2x Accessories package 1 3x pull-out compartment with non-slip mat	2x Accessories package 1 5x pull-out compartment with non-slip mat	2x Accessories package 1 5x pull-out compartment with non-slip mat
Note on standard	-	IP 44	-	IP 44
Installation	wall-mounted	wall-mounted	wall-mounted	wall-mounted
Scope of delivery	fastening set included	fastening set included	fastening set included	fastening set included
DH, E8, FP, MS, PN, RH, RK, VG, VH, VJ, VK				
PD				





XX = Insert front and body colour
 DH = Glossy White, FP = Glossy Grey, MS = White Matt, PD = Black Matt
 Lacquer, VG = Truffle Grey, VK = Soft Grey, E8 = White Wood, PN = Elm
 Impresso, RH = Oak Kansas, RK = Stone Oak, VH = Arizona Oak, VJ =
 Nordic Oak

LEGATO

€ excl. VAT

Registered design

Produced to order (Please note that it is not always possible to cancel or change orders!), The washbasins are to be ordered separately.

	VANITY UNIT	VANITY UNIT	VANITY UNIT	VANITY UNIT
				
Article number	B757 00 XX	B757 L0 XX	B758 00 XX	B758 L0 XX
Dimensions (w x h x d)	1200 x 380 x 500 mm	1200 x 380 x 500 mm	1200 x 550 x 500 mm	1200 x 550 x 500 mm
Version	washbasin on the middle	washbasin on the middle	washbasin on the middle	washbasin on the middle
For combination with	Finion 4142 61/64 Memento 2.0 4A07 60/61	Finion 4142 61/64 Memento 2.0 4A07 60/61	Finion 4142 61/64 Memento 2.0 4A07 60/61	Finion 4142 61/64 Memento 2.0 4A07 60/61
Lighting	-	LED lighting Lighting 1x LED / 27,9 W	-	LED lighting Lighting 1x LED / 27,9 W
Equipped with	1x Accessories package 1 3x pull-out compartment with non-slip mat	1x Accessories package 1 3x pull-out compartment with non-slip mat	1x Accessories package 1 5x pull-out compartment with non-slip mat	1x Accessories package 1 5x pull-out compartment with non-slip mat
Note on standard	-	IP 44	-	IP 44
Installation	wall-mounted	wall-mounted	wall-mounted	wall-mounted
Scope of delivery	fastening set included	fastening set included	fastening set included	fastening set included
DH, E8, FP, MS, PN, RH, RK, VG, VH, VJ, VK				
PD				
	VANITY UNIT	VANITY UNIT	VANITY UNIT	VANITY UNIT
				
Article number	B755 00 XX	B755 L0 XX	B756 00 XX	B756 L0 XX
Dimensions (w x h x d)	1000 x 380 x 500 mm	1000 x 380 x 500 mm	1000 x 550 x 500 mm	1000 x 550 x 500 mm
Version	washbasin on the middle	washbasin on the middle	washbasin on the middle	washbasin on the middle
For combination with	Finion 4142 61/64 Memento 2.0 4A07 60/61	Finion 4142 61/64 Memento 2.0 4A07 60/61	Finion 4142 61/64 Memento 2.0 4A07 60/61	Finion 4142 61/64 Memento 2.0 4A07 60/61
Lighting	-	LED lighting Lighting 1x LED / 24,8 W	-	LED lighting Lighting 1x LED / 24,8 W
Equipped with	1x Accessories package 1 1x pull-out compartment with non-slip mat	1x Accessories package 1 1x pull-out compartment with non-slip mat	1x Accessories package 1 2x pull-out compartment with non-slip mat	1x Accessories package 1 2x pull-out compartment with non-slip mat
Note on standard	-	IP 44	-	IP 44
Installation	wall-mounted	wall-mounted	wall-mounted	wall-mounted
Scope of delivery	fastening set included	fastening set included	fastening set included	fastening set included
DH, E8, FP, MS, PN, RH, RK, VG, VH, VJ, VK				
PD				

LEGATO









XX = Insert front and body colour
 DH = Glossy White, FP = Glossy Grey, MS = White Matt, PD = Black Matt
 Lacquer, VG = Truffle Grey, VK = Soft Grey, E8 = White Wood, PN = Elm
 Impresso, RH = Oak Kansas, RK = Stone Oak, VH = Arizona Oak, VJ =
 Nordic Oak

LEGATO

€ excl. VAT

Registered design

Produced to order (Please note that it is not always possible to cancel or change orders!), The washbasins are to be ordered separately.

	VANITY UNIT	VANITY UNIT	VANITY UNIT	VANITY UNIT
				
Article number	B753 00 XX	B753 L0 XX	B754 00 XX	B754 L0 XX
Dimensions (w x h x d)	800 x 380 x 500 mm	800 x 380 x 500 mm	800 x 550 x 500 mm	800 x 550 x 500 mm
Version	washbasin on the middle	washbasin on the middle	washbasin on the middle	washbasin on the middle
For combination with	Finion 4142 61/64 Memento 2.0 4A07 60/61	Finion 4142 61/64 Memento 2.0 4A07 60/61	Finion 4142 61/64 Memento 2.0 4A07 60/61	Finion 4142 61/64 Memento 2.0 4A07 60/61
Lighting	-	LED lighting Lighting 1x LED / 21,6 W	-	LED lighting Lighting 1x LED / 21,6 W
Equipped with	1x Accessories package 1 1x pull-out compartment with non-slip mat	1x Accessories package 1 1x pull-out compartment with non-slip mat	1x Accessories package 1 2x pull-out compartment with non-slip mat	1x Accessories package 1 2x pull-out compartment with non-slip mat
Note on standard	-	IP 44	-	IP 44
Installation	wall-mounted	wall-mounted	wall-mounted	wall-mounted
Scope of delivery	fastening set included	fastening set included	fastening set included	fastening set included
DH, E8, FP, MS, PN, RH, RK, VG, VH, VJ, VK				
PD				
	CUPBOARD UNIT	CUPBOARD UNIT	CUPBOARD UNIT	CUPBOARD UNIT
				
Article number	B724 00 XX	B724 01 XX	B726 00 XX	B726 01 XX
Dimensions (w x h x d)	400 x 340 x 500 mm	400 x 340 x 500 mm	400 x 340 x 500 mm	400 x 340 x 500 mm
Version	left, for connecting to vanity unit with surface-mounted washbasin	right and central, for connecting to vanity unit with surface-mounted washbasin	left, for connecting to vanity unit with surface-mounted washbasin	right and central, for connecting to vanity unit with surface-mounted washbasin
Equipped with	1x glass shelf	1x glass shelf	1x pull-out compartment with non-slip mat	1x pull-out compartment with non-slip mat
Installation	wall-mounted	wall-mounted	wall-mounted	wall-mounted
Scope of delivery	fastening set included	fastening set included	fastening set included	fastening set included
DH, E8, FP, MS, PN, RH, RK, VG, VH, VJ, VK				
PD				

LEGATO



XX = Insert front and body colour
 DH = Glossy White, FP = Glossy Grey, MS = White Matt, PD = Black Matt
 Lacquer, VG = Truffle Grey, VK = Soft Grey, E8 = White Wood, PN = Elm
 Impresso, RH = Oak Kansas, RK = Stone Oak, VH = Arizona Oak, VJ =
 Nordic Oak

LEGATO

€ excl. VAT

Registered design

Produced to order (Please note that it is not always possible to cancel or change orders!), The washbasins are to be ordered separately.

	SIDE CABINET		TALL CABINET	
				
Article number	B728 00 XX	B728 01 XX	B730 00 XX	B730 01 XX
Dimensions (w x h x d)	400 x 870 x 350 mm	400 x 870 x 350 mm	400 x 1550 x 350 mm	400 x 1550 x 350 mm
Hinges	hinges on left	hinges on right	hinges on left	hinges on right
Equipped with	1x door 2x drawer with slip-resistant base 1x shelf	1x door 2x drawer with slip-resistant base 1x shelf	2x door 3x shelf	2x door 3x shelf
Installation	wall-mounted	wall-mounted	wall-mounted	wall-mounted
Scope of delivery	fastening set included	fastening set included	fastening set included	fastening set included
DH, E8, FP, MS, PN, RH, RK, VG, VH, VJ, VK				
PD				

LEGATO

XX = Insert front and body colour
 DH = Glossy White, FP = Glossy Grey, MS = White Matt, PD = Black Matt
 Lacquer, VG = Truffle Grey, VK = Soft Grey, E8 = White Wood, PN = Elm
 Impreso, RH = Oak Kansas, RK = Stone Oak, VH = Arizona Oak, VJ =
 Nordic Oak

LOOP & FRIENDS

Bath ceramic

- Mainstream segment
- Matching furniture programme Legato
- matching Subway 2.0 toilet
- Designed to match all mirror collections
- Designed to match all mirror cabinet collections
- matching Loop & Friends baths

PRO.VILLEROY-BOCH.COM/TECHNICALDRAWINGS



LOOP & FRIENDS

Ceramic colours



01 = White Alpin



R1 = White Alpin
CeramicPlus



RW = Stone
White
CeramicPlus



S5 = Ebony
CeramicPlus



i4 = Graphite
CeramicPlus



AM = Almond
CeramicPlus

LOOP & FRIENDS

€ excl. VAT

Registered design

Please order tap fittings and soap dispenser separately

SURFACE-MOUNTED WASHBASIN

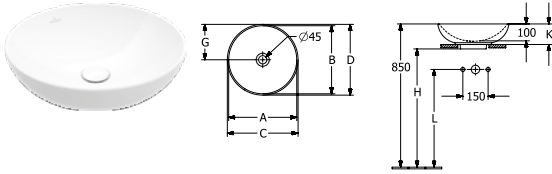

Article no.	A	B	C	D	G	H	K	L
4A4500XX	365	365	380	380	190	700	120	580
4A4501XX	365	365	380	380	190	700	120	580
4A4600XX	405	405	420	420	210	700	120	580
4A4601XX	405	405	420	420	210	700	120	580

Article number	Description	01	R1	RW, S5, i4, AM	pcs/pal.	kg/pc.
4A45 00 XX	380 mm Diameter for wall-mounted washbasin mixers or tall pillar tap fittings, without tap hole area incl. template, incl. extended ball rod for pop-up waste, fastening set included				18	6,9
4A45 01 XX	380 mm Diameter for wall-mounted washbasin mixers or tall pillar tap fittings, without tap hole area incl. template, fastening set included				18	6,9
4A46 00 XX	420 mm Diameter for wall-mounted washbasin mixers or tall pillar tap fittings, without tap hole area incl. template, incl. extended ball rod for pop-up waste, fastening set included				18	8,2
4A46 01 XX	420 mm Diameter for wall-mounted washbasin mixers or tall pillar tap fittings, without tap hole area incl. template, fastening set included				18	8,2

matching furniture programme: Legato

For further information about matching valves, see pages 380-383

Please note: unclosable outlet valve must be used with models without overflow

SURFACE-MOUNTED WASHBASIN

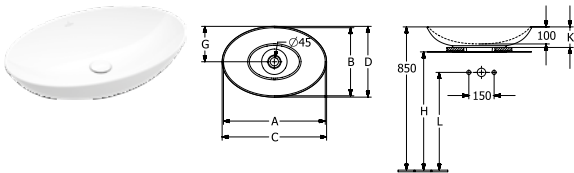

Article no.	A	B	C	D	G	H	K	L
4A4700XX	545	365	560	380	190	700	120	580
4A4701XX	545	365	560	380	190	700	120	580
4A4800XX	605	405	620	420	210	700	120	580
4A4801XX	605	405	620	420	210	700	120	580

Article number	Description	01	R1	RW, S5, i4, AM	pcs/pal.	kg/pc.
4A47 00 XX	560 x 380 mm for wall-mounted washbasin mixers or tall pillar tap fittings, without tap hole area incl. template, incl. extended ball rod for pop-up waste, fastening set included				12	10
4A47 01 XX	560 x 380 mm for wall-mounted washbasin mixers or tall pillar tap fittings, without tap hole area incl. template, fastening set included				12	10
4A48 00 XX	620 x 420 mm for wall-mounted washbasin mixers or tall pillar tap fittings, without tap hole area incl. template, incl. extended ball rod for pop-up waste, fastening set included				12	11,8
4A48 01 XX	620 x 420 mm for wall-mounted washbasin mixers or tall pillar tap fittings, without tap hole area incl. template, fastening set included				12	11,8

matching furniture programme: Legato

For further information about matching valves, see pages 380-383

Please note: unclosable outlet valve must be used with models without overflow

The colours RW, S5, i4 and AM are made to order. Please enquire about delivery times when ordering.

XX = Colour code to be indicated

01 = White Alpin, R1 = White Alpin CeramicPlus, RW = Stone White CeramicPlus, S5 = Ebony CeramicPlus, i4 = Graphite CeramicPlus, AM = Almond CeramicPlus

LOOP & FRIENDS

€ excl. VAT



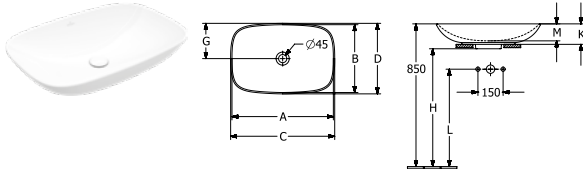

Registered design

Please order tap fittings and soap dispenser separately

SURFACE-MOUNTED WASHBASIN



Article no.	A	B	C	D	G	H	K	L
4A4900XX	545	365	560	380	190	700	120	580
4A4901XX	545	365	560	380	190	700	120	580
4A5000XX	605	405	620	420	210	700	120	580
4A5001XX	605	405	620	420	210	700	120	580

Article number	Description	01	R1	RW, S5, i4, AM	pcs/pal.	kg/pc.
4A49 00 XX	560 x 380 mm for wall-mounted washbasin mixers or tall pillar tap fittings, without tap hole area  incl. Titan Ceram NEW				12	11,3
4A49 01 XX	560 x 380 mm for wall-mounted washbasin mixers or tall pillar tap fittings, without tap hole area  incl. Titan Ceram NEW				12	11,3
4A50 00 XX	620 x 420 mm for wall-mounted washbasin mixers or tall pillar tap fittings, without tap hole area  incl. Titan Ceram NEW				12	13,4
4A50 01 XX	620 x 420 mm for wall-mounted washbasin mixers or tall pillar tap fittings, without tap hole area  incl. Titan Ceram NEW				12	13,4

matching furniture programme: Legato

For further information about matching valves, see pages 380-383

Please note: unclosable outlet valve must be used with models without overflow

The colours RW, S5, i4 and AM are made to order. Please enquire about delivery times when ordering.

XX = Colour code to be indicated

01 = White Alpin, R1 = White Alpin CeramicPlus, RW = Stone White CeramicPlus, S5 = Ebony CeramicPlus, i4 = Graphite CeramicPlus, AM = Almond CeramicPlus

LOOP & FRIENDS

€ excl. VAT



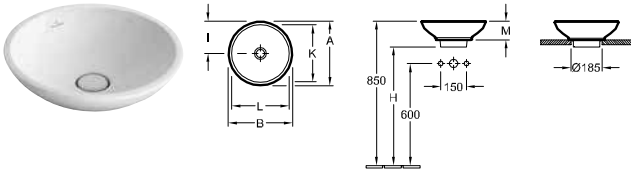

Registered design

Please order tap fittings and soap dispenser separately

SURFACE-MOUNTED WASHBASIN



Article no.	A	B	G	H	I	K	L	M
514400XX	430	430	570	690	215	390	390	120
514401XX	430	430	570	690	215	390	390	120
514800XX	380	380	580	700	190	340	340	110
514801XX	380	380	580	700	190	340	340	110

Article number	Description	01	plus R1	pcs/ pal.	kg/ pc.
5144 00 XX	430 mm Diameter for wall-mounted washbasin mixers or tall pillar tap fittings, without tap hole area  incl. template, incl. valve with ceramic valve cover. Can be closed using standard turn-knob outlet valve, incl. extended ball rod for pop-up waste, fastening set included			27	7,8
5144 01 XX	430 mm Diameter for wall-mounted washbasin mixers or tall pillar tap fittings, without tap hole area  incl. template, incl. unclosable valve with ceramic valve cover, fastening set included			27	7,8
5148 00 XX	380 mm Diameter for wall-mounted washbasin mixers or tall pillar tap fittings, without tap hole area  incl. template, incl. valve with ceramic valve cover. Can be closed using standard turn-knob outlet valve, incl. extended ball rod for pop-up waste, fastening set included			27	6,5
5148 01 XX	380 mm Diameter for wall-mounted washbasin mixers or tall pillar tap fittings, without tap hole area  incl. template, incl. unclosable valve with ceramic valve cover, fastening set included			27	6,5

matching furniture programme: Legato



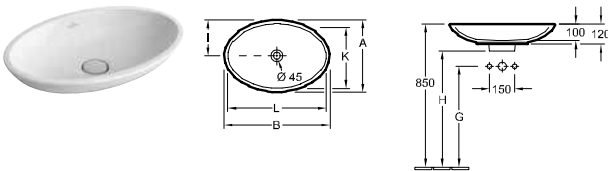

For further information about matching valves, see pages 380-383

Please note: unclosable outlet valve must be used with models without overflow

SURFACE-MOUNTED WASHBASIN



Article no.	A	B	G	H	I	K	L
515110XX	430	630	570	690	215	390	590
515111XX	430	630	570	690	215	390	590
515100XX	380	585	580	700	190	340	545
515101XX	380	585	580	700	190	340	545

Article number	Description	01	plus R1	pcs/ pal.	kg/ pc.
5151 10 XX	630 x 430 mm for wall-mounted washbasin mixers or tall pillar tap fittings, without tap hole area  incl. template, incl. valve with ceramic valve cover. Can be closed using standard turn-knob outlet valve, incl. extended ball rod for pop-up waste, fastening set included			18	10,8
5151 11 XX	630 x 430 mm for wall-mounted washbasin mixers or tall pillar tap fittings, without tap hole area  incl. template, incl. unclosable valve with ceramic valve cover, fastening set included			18	10,8
5151 00 XX	585 x 380 mm for wall-mounted washbasin mixers or tall pillar tap fittings, without tap hole area  incl. template, incl. valve with ceramic valve cover. Can be closed using standard turn-knob outlet valve, incl. extended ball rod for pop-up waste, fastening set included			18	9,2
5151 01 XX	585 x 380 mm for wall-mounted washbasin mixers or tall pillar tap fittings, without tap hole area  incl. template, incl. unclosable valve with ceramic valve cover, fastening set included			18	9,2

matching furniture programme: Legato

For further information about matching valves, see pages 380-383

Please note: unclosable outlet valve must be used with models without overflow

XX = Colour code to be indicated

01 = White Alpin, R1 = White Alpin CeramicPlus, RW = Stone White CeramicPlus, S5 = Ebony CeramicPlus, i4 = Graphite CeramicPlus, AM = Almond CeramicPlus

LOOP & FRIENDS

€ excl. VAT

Registered design

Please order tap fittings and soap dispenser separately

SURFACE-MOUNTED WASHBASIN

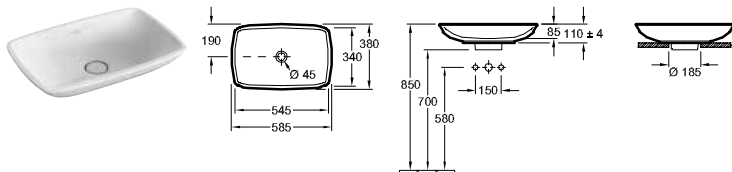

Article number	Description	01	plus R1	pcs/ pal.	kg/ pc.
5154 00 XX	585 x 380 mm for wall-mounted washbasin mixers or tall pillar tap fittings, without tap hole area incl. template, incl. valve with ceramic valve cover. Can be closed using standard turn-knob outlet valve, incl. extended ball rod for pop-up waste, fastening set included			18	10,3
5154 01 XX	585 x 380 mm for wall-mounted washbasin mixers or tall pillar tap fittings, without tap hole area incl. template, incl. unclosable valve with ceramic valve cover, fastening set included			18	10,3

matching furniture programme: Legato

For further information about matching valves, see pages 380-383

Please note: unclosable outlet valve must be used with models without overflow

BUILT-IN WASHBASIN

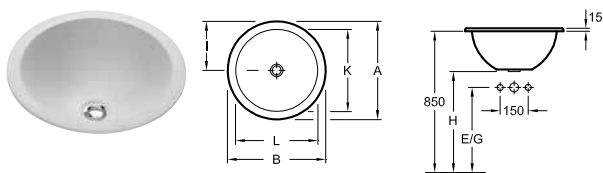

Article no.	A	B	E	G	H	I	K	L
614045XX	450	450	540	540	660	225	380	380
614039XX	390	390	560	560	680	195	330	330

Article number	Description	01	plus R1	pcs/ pal.	kg/ pc.
6140 45 XX	450 mm Diameter without tap hole area incl. template, incl. extended ball rod for pop-up waste			24	10,7
6140 39 XX	390 mm Diameter without tap hole area incl. template			36	8

outside surface glazed

For further information about matching valves, see pages 380-383

BUILT-IN WASHBASIN

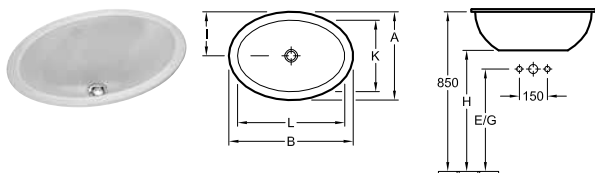

Article no.	A	B	E	G	H	I	K	L
615530XX	470	660	515	515	635	235	380	570
615520XX	410	570	530	530	650	205	325	485
615510XX	360	505	560	560	680	180	285	439

Article number	Description	01	plus R1	pcs/ pal.	kg/ pc.
6155 30 XX	660 x 470 mm without tap hole area incl. template, incl. extended ball rod for pop-up waste			15	16,7
6155 20 XX	570 x 410 mm without tap hole area incl. template, incl. extended ball rod for pop-up waste			24	12,7
6155 10 XX	505 x 360 mm without tap hole area incl. template			36	9,5

outside surface glazed

For further information about matching valves, see pages 380-383

LOOP & FRIENDS

XX = Colour code to be indicated

01 = White Alpin, R1 = White Alpin CeramicPlus, RW = Stone White CeramicPlus, S5 = Ebony CeramicPlus, i4 = Graphite CeramicPlus, AM = Almond CeramicPlus

LOOP & FRIENDS

€ excl. VAT



Registered design

Please order tap fittings and soap dispenser separately

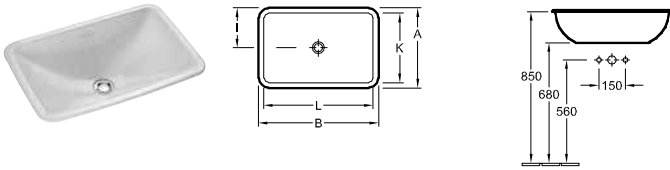
BUILT-IN WASHBASIN



Article no.	A	B	I	K	L
614520XX	450	675	225	380	615
614500XX	405	600	203	345	540
614510XX	340	510	170	280	450

Article number	Description	01	plus R1	pcs/ pal.	kg/ pc.
6145 20 XX	675 x 450 mm without tap hole area 			15	17,3
6145 00 XX	600 x 405 mm without tap hole area 			12	14,5
6145 10 XX	510 x 340 mm without tap hole area 			36	10,1



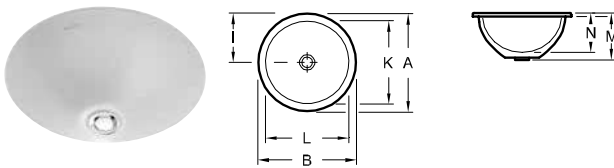

outside surface glazed, incl. template, incl. extended ball rod for pop-up waste

For further information about matching valves, see pages 380-383

UNDERCOUNTER WASHBASIN



Article no.	A	B	I	K	L	M	N
618038XX	450	450	225	380	380	210	160
618138XX	450	450	225	380	380	210	160
618033XX	390	390	195	330	330	190	140
618133XX	390	390	195	330	330	190	160

Article number	Description	01	plus R1	pcs/ pal.	kg/ pc.
6180 38 XX	380 mm Diameter without tap hole area  incl. extended ball rod for pop-up waste, fastening set included			24	10,7
6181 38 XX	380 mm Diameter without tap hole area  fastening set included			24	10,7
6180 33 XX	330 mm Diameter without tap hole area  fastening set included			36	8
6181 33 XX	330 mm Diameter without tap hole area  fastening set included			36	8

outside surface glazed, the hole for the washbasin can only be cut out using the original washbasin because tolerances of several millimetres are possible, installation possible in natural stone and laminate countertops





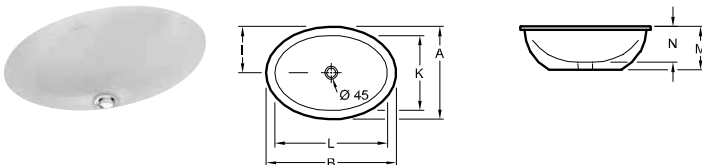

For further information about matching valves, see pages 380-383

Please note: unclosable outlet valve must be used with models without overflow

UNDERCOUNTER WASHBASIN



Article no.	A	B	I	K	L	M	N
616130XX	470	660	235	375	560	215	180
616131XX	470	660	235	375	560	215	180
616120XX	405	570	203	325	485	200	160
616121XX	405	570	203	325	485	200	160
616110XX	355	500	178	285	430	180	140
616111XX	355	500	178	285	430	180	140

Article number	Description	01	plus R1	pcs/ pal.	kg/ pc.
6161 30 XX	560 x 375 mm without tap hole area  incl. extended ball rod for pop-up waste, fastening set included			15	16,7
6161 31 XX	560 x 375 mm without tap hole area  fastening set included			15	16,7
6161 20 XX	485 x 325 mm without tap hole area  incl. extended ball rod for pop-up waste, fastening set included			24	12,7
6161 21 XX	485 x 325 mm without tap hole area  fastening set included			24	12,7
6161 10 XX	430 x 285 mm without tap hole area  fastening set included			42	9,5
6161 11 XX	430 x 285 mm without tap hole area  fastening set included			42	9,5

outside surface glazed, the hole for the washbasin can only be cut out using the original washbasin because tolerances of several millimetres are possible, installation possible in natural stone and laminate countertops

For further information about matching valves, see pages 380-383

Please note: unclosable outlet valve must be used with models without overflow

XX = Colour code to be indicated

01 = White Alpin, R1 = White Alpin CeramicPlus, RW = Stone White CeramicPlus, S5 = Ebony CeramicPlus, i4 = Graphite CeramicPlus, AM = Almond CeramicPlus

LOOP & FRIENDS

€ excl. VAT

Registered design

Please order tap fittings and soap dispenser separately

UNDERCOUNTER WASHBASIN

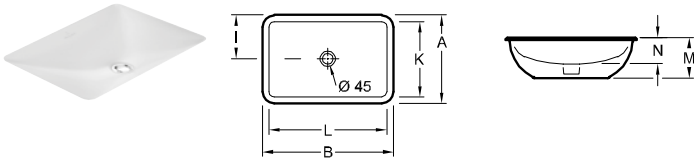

Article no.	A	B	L	K	L	M	N
616320XX	450	675	225	380	615	175	140
616321XX	450	675	225	380	615	175	140
616300XX	405	600	203	340	540	180	120
616301XX	405	600	203	340	540	180	120
616310XX	340	510	170	280	450	160	115
616311XX	340	510	170	280	450	160	115

Article number	Description	01	plus R1	pcs/ pal.	kg/ pc.
6163 20 XX	615 x 380 mm without tap hole area incl. extended ball rod for pop-up waste, fastening set included			15	17,3
6163 21 XX	615 x 380 mm without tap hole area fastening set included			15	17,3
6163 00 XX	540 x 340 mm without tap hole area incl. extended ball rod for pop-up waste, fastening set included			12	14,5
6163 01 XX	540 x 340 mm without tap hole area fastening set included			12	14,5
6163 10 XX	450 x 280 mm without tap hole area incl. extended ball rod for pop-up waste, fastening set included			42	10,1
6163 11 XX	450 x 280 mm without tap hole area fastening set included			42	10,1

outside surface glazed, the hole for the washbasin can only be cut out using the original washbasin because tolerances of several millimetres are possible, installation possible in natural stone and laminate countertops

For further information about matching valves, see pages 380-383

Please note: unclosable outlet valve must be used with models without overflow

WASHDOWN TOILET, RIMLESS

DirectFlush

We recommend the SUBWAY 3.0 toilet for LOOP & FRIENDS

For further information on toilet seats, see the chapter on SUBWAY 2.0

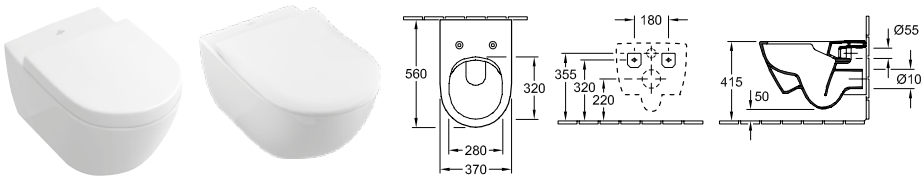

Article number	Description	01	plus R1	plus RW, S5, i4	pcs/ pal.	kg/ pc.
5614 R0 XX	370 x 560 mm				-	12 25,2

wall-mounted, horizontal outlet, incl. fastening set "SupraFix 3.0", with water-saving AQUAREDUCT® system: flush volume 3 / 4,5 litres, not suitable for installation with flush valves

8M42 S1 XX	TOILET SEAT AND COVER with QuickRelease and SoftClosing hinges, hinges in stainless steel NEW		-	-	-	2,63
9M68 S1 XX	TOILET SEAT AND COVER with QuickRelease and SoftClosing hinges, hinges in stainless steel		-	-	-	90 3,647
9M78 S1 XX	TOILET SEAT AND COVER SLIMSEAT with QuickRelease and SoftClosing hinges, hinges in stainless steel		-	-	-	90 2,968
9M68 Q1 XX	TOILET SEAT AND COVER with QuickRelease hinges, hinges in stainless steel		-	-	-	90 3,647
9M74 61 01	SEAT hinges in stainless steel		-	-	-	90 1,35
9222 87 00	VIPROTECT SOUNDPROOFING SET (optional) incl. accessories		-	-	-	600 0,086
9224 65 00	TOILET INSTALLATION SYSTEM for dry-wall construction, low 450 x 1120 x 165 mm For further ViConnect models, see pages 368-379		-	-	-	8 19,78
9224 27 00	TOILET INSTALLATION SYSTEM for dry-wall construction, standard height 525 x 1120 x 135 mm For further ViConnect models, see pages 368-379		-	-	-	10 15,8

XX = Colour code to be indicated

01 = White Alpin, R1 = White Alpin CeramicPlus, RW = Stone White CeramicPlus, S5 = Ebony CeramicPlus, i4 = Graphite CeramicPlus, AM = Almond CeramicPlus

MEMENTO 2.0

Bath ceramic

- Premium segment
- Matching furniture programme Finion, Legato

PRO.VILLEROY-BOCH.COM/TECHNICALDRAWINGS



Ceramic colours



01 = White Alpin



R1 = White Alpin
CeramicPlus



RW = Stone
White
CeramicPlus



S5 = Ebony
CeramicPlus



i4 = Graphite
CeramicPlus

MEMENTO 2.0

€ excl. VAT

Please order tap fittings and soap dispenser separately

WASHBASINS

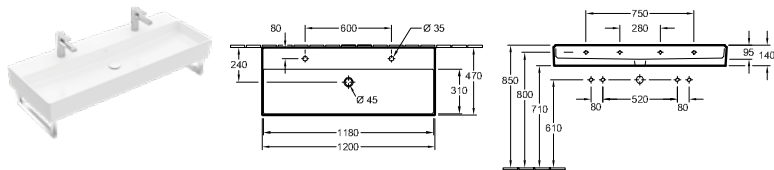

Article number	Description	01	plus R1	plus RW, S5, i4	pcs/ pal.	kg/ pc.
4A22 C1 XX	1200 x 470 mm 2xØ				8	34,65
4A22 C4 XX	1200 x 470 mm 2xØ with 2 single-lever mixers and turn-knob operation or in conjunction with toggle valve, as well as push-open valve, please do not exceed a flow rate of max. 7.5 l/min per tap fitting.				8	34,65
wall fixation, towel holder (not included in scope of delivery): side installation (mountable: 2 pc.) For further information about matching valves, see pages 380-383 A non-closing valve or the ViFlow (concealed overflow) must be used for models without overflow function.						
8749 42 D7	TOWEL RAIL (optional) 420 x 140 mm, stainless steel, side installation, fastening set included	-	-	-		1,9
9221 49 00	WASHBASIN INSTALLATION ELEMENT 525 x 1120 x 75 mm For further ViConnect models, see pages 368-379		-	-	10	8,05

WASHBASINS

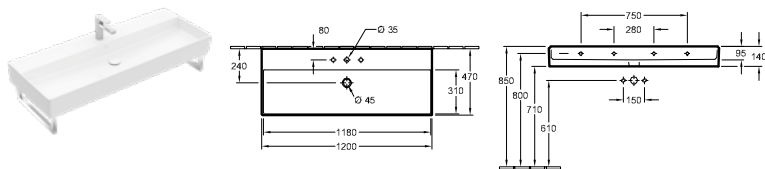

Article number	Description	01	plus R1	plus RW, S5, i4	pcs/ pal.	kg/ pc.
4A22 C5 XX	1200 x 470 mm				8	34,65
4A22 C2 XX	1200 x 470 mm				8	34,65
wall fixation, towel holder (not included in scope of delivery): side installation (mountable: 2 pc.) For further information about matching valves, see pages 380-383 A non-closing valve or the ViFlow (concealed overflow) must be used for models without overflow function.						
8749 42 D7	TOWEL RAIL (optional) 420 x 140 mm, stainless steel, side installation, fastening set included	-	-	-		1,9
9221 49 00	WASHBASIN INSTALLATION ELEMENT 525 x 1120 x 75 mm For further ViConnect models, see pages 368-379		-	-	10	8,05

The colours S5 and i4 are made to order. Please enquire about delivery times when ordering.

XX = Colour code to be indicated
 01 = White Alpin, R1 = White Alpin CeramicPlus, RW = Stone White CeramicPlus, S5 = Ebony CeramicPlus, i4 = Graphite CeramicPlus

MEMENTO 2.0

€ excl. VAT

Please order tap fittings and soap dispenser separately

WASHBASINS

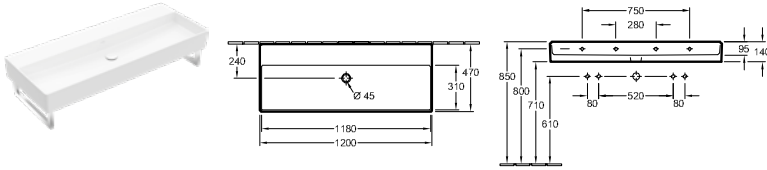

Article number	Description	01	plus R1	plus RW, S5, i4	pcs/ pal.	kg/ pc.
4A22 C3 XX	1200 x 470 mm  				-	8 34,65

wall fixation, towel holder (not included in scope of delivery): side installation (mountable: 2 pc.), when using a wall-mounted tap fitting, we recommend a projection of at least 205 mm





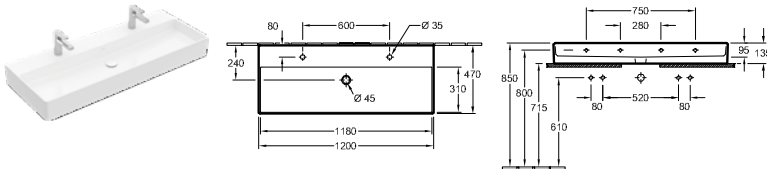

For further information about matching valves, see pages 380-383

Please note: unclosable outlet valve must be used with models without overflow

8749 42 D7	TOWEL RAIL (optional) 420 x 140 mm, stainless steel, side installation, fastening set included	-	-	-		1,9
9221 49 00	WASHBASIN INSTALLATION ELEMENT 525 x 1120 x 75 mm For further ViConnect models, see pages 368-379		-	-	-	10 8,05

WASHBASINS



Article number	Description	01	plus R1	plus RW, S5, i4	pcs/ pal.	kg/ pc.
4A22 CK XX	1200 x 470 mm   with 2 single-lever mixers and turn-knob operation or in conjunction with toggle valve, as well as push-open valve, please do not exceed a flow rate of max. 7.5 l/min per tap fitting.				-	8 36,75
4A22 CG XX	1200 x 470 mm  				-	8 36,75

ground underside, wall fixation, incl. template, matching furniture programme: Finion, Legato

For further information about matching valves, see pages 380-383

A non-closing valve or the ViFlow (concealed overflow) must be used for models without overflow function.

9221 49 00	WASHBASIN INSTALLATION ELEMENT 525 x 1120 x 75 mm For further ViConnect models, see pages 368-379		-	-	-	10 8,05
------------	---	---	---	---	---	---------

The colours S5 and i4 are made to order. Please enquire about delivery times when ordering.

XX = Colour code to be indicated

01 = White Alpin, R1 = White Alpin CeramicPlus, RW = Stone White CeramicPlus, S5 = Ebony CeramicPlus, i4 = Graphite CeramicPlus







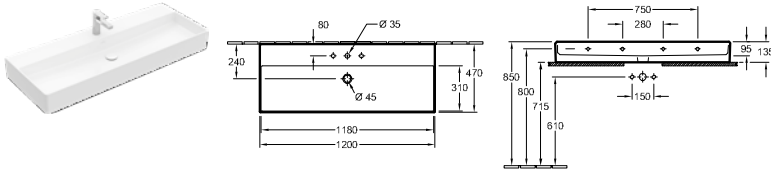

MEMENTO 2.0

€ excl. VAT

Please order tap fittings and soap dispenser separately

WASHBASINS



Article number	Description		01	plus R1	plus RW, S5, i4		pcs/ pal.	kg/ pc.
4A22 CL XX	1200 x 470 mm   					-	8	36,75
4A22 CH XX	1200 x 470 mm   					-	8	36,75

ground underside, wall fixation, incl. template, matching furniture programme: Finion, Legato



For further information about matching valves, see pages 380-383

A non-closing valve or the ViFlow (concealed overflow) must be used for models without overflow function.

9221 49 00	WASHBASIN INSTALLATION ELEMENT 525 x 1120 x 75 mm For further ViConnect models, see pages 368-379		-	-	-		10	8,05
------------	--	---	---	---	---	--	----	------

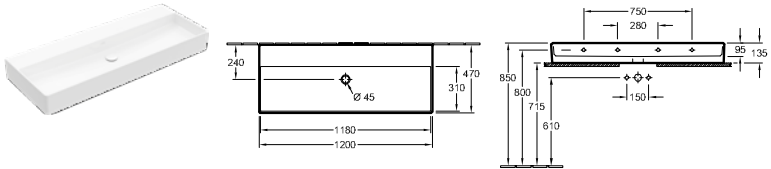
WASHBASINS



Article number	Description		01	plus R1	plus RW, S5, i4		pcs/ pal.	kg/ pc.
4A22 CF XX	1200 x 470 mm  					-	8	36,75

ground underside, wall fixation, incl. template, when using a wall-mounted tap fitting, we recommend a projection of at least 205 mm, matching furniture programme: Finion, Legato

For further information about matching valves, see pages 380-383

Please note: unclosable outlet valve must be used with models without overflow

9221 49 00	WASHBASIN INSTALLATION ELEMENT 525 x 1120 x 75 mm For further ViConnect models, see pages 368-379		-	-	-		10	8,05
------------	--	---	---	---	---	--	----	------

The colours S5 and i4 are made to order. Please enquire about delivery times when ordering.

XX = Colour code to be indicated

01 = White Alpin, R1 = White Alpin CeramicPlus, RW = Stone White CeramicPlus, S5 = Ebony CeramicPlus, i4 = Graphite CeramicPlus

MEMENTO 2.0

€ excl. VAT

Please order tap fittings and soap dispenser separately

WASHBASINS

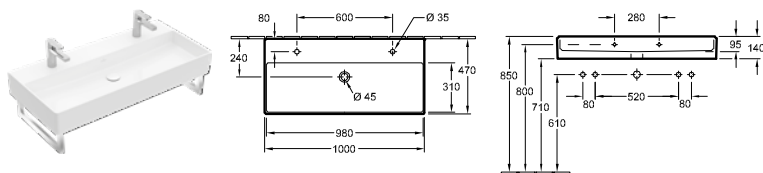

Article number	Description	01	plus R1	plus RW, S5, i4	pcs/ pal.	kg/ pc.
4A22 A4 XX	1000 x 470 mm 2xØ with 2 single-lever mixers and turn-knob operation or in conjunction with toggle valve, as well as push-open valve, please do not exceed a flow rate of max. 7.5 l/min per tap fitting.	Titan Ceram			8	29,1
4A22 A1 XX	1000 x 470 mm 2xØ	Titan Ceram			8	29,1

wall fixation, towel holder (not included in scope of delivery): side installation (mountable: 2 pc.)
For further information about matching valves, see pages 380-383
A non-closing valve or the ViFlow (concealed overflow) must be used for models without overflow function.

8749 42 D7	TOWEL RAIL (optional) 420 x 140 mm, stainless steel, side installation, fastening set included	-	-	-		1,9
9221 49 00	WASHBASIN INSTALLATION ELEMENT 525 x 1120 x 75 mm For further ViConnect models, see pages 368-379				10	8,05

WASHBASINS

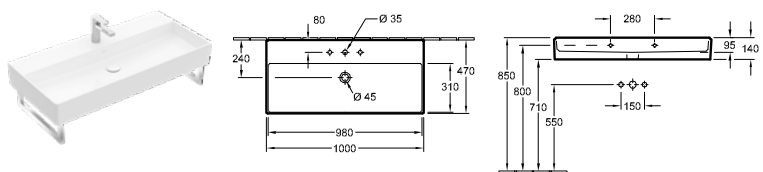

Article number	Description	01	plus R1	plus RW, S5, i4	pcs/ pal.	kg/ pc.
4A22 A5 XX	1000 x 470 mm	Titan Ceram			8	29,1
4A22 A2 XX	1000 x 470 mm	Titan Ceram			8	29,1

wall fixation, towel holder (not included in scope of delivery): side installation (mountable: 2 pc.)
For further information about matching valves, see pages 380-383
A non-closing valve or the ViFlow (concealed overflow) must be used for models without overflow function.

8749 42 D7	TOWEL RAIL (optional) 420 x 140 mm, stainless steel, side installation, fastening set included	-	-	-		1,9
9221 49 00	WASHBASIN INSTALLATION ELEMENT 525 x 1120 x 75 mm For further ViConnect models, see pages 368-379				10	8,05

The colours S5 and i4 are made to order. Please enquire about delivery times when ordering.

XX = Colour code to be indicated
01 = White Alpin, R1 = White Alpin CeramicPlus, RW = Stone White CeramicPlus, S5 = Ebony CeramicPlus, i4 = Graphite CeramicPlus

MEMENTO 2.0

€ excl. VAT

Please order tap fittings and soap dispenser separately

WASHBASINS

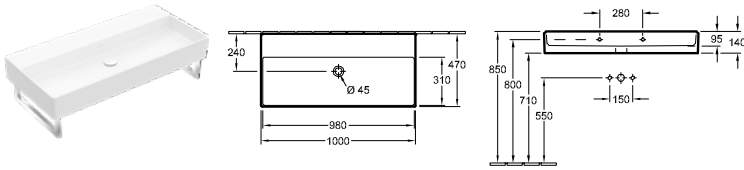

Article number	Description		01	plus R1	plus RW, S5, i4		pcs/ pal.	kg/ pc.
4A22 A3 XX	1000 x 470 mm	Titan Ceram				-	8	29,1

wall fixation, towel holder (not included in scope of delivery): side installation (mountable: 2 pc.), when using a wall-mounted tap fitting, we recommend a projection of at least 205 mm

For further information about matching valves, see pages 380-383

Please note: unclosable outlet valve must be used with models without overflow

8749 42 D7	TOWEL RAIL (optional) 420 x 140 mm, stainless steel, side installation, fastening set included		-	-	-			1,9
9221 49 00	WASHBASIN INSTALLATION ELEMENT 525 x 1120 x 75 mm For further ViConnect models, see pages 368-379		-	-	-		10	8,05

WASHBASINS

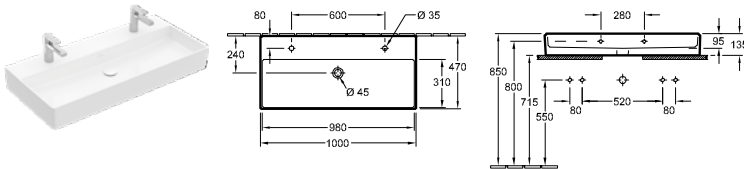

Article number	Description		01	plus R1	plus RW, S5, i4		pcs/ pal.	kg/ pc.
4A22 1L XX	1000 x 470 mm with 2 single-lever mixers and turn-knob operation or in conjunction with toggle valve, as well as push-open valve, please do not exceed a flow rate of max. 7.5 l/min per tap fitting.	Titan Ceram				-	8	29
4A22 1K XX	1000 x 470 mm	Titan Ceram				-	8	29

ground underside, wall fixation, incl. template, matching furniture programme: Finion, Legato

For further information about matching valves, see pages 380-383

A non-closing valve or the ViFlow (concealed overflow) must be used for models without overflow function.

9221 49 00	WASHBASIN INSTALLATION ELEMENT 525 x 1120 x 75 mm For further ViConnect models, see pages 368-379		-	-	-		10	8,05
------------	---	--	---	---	---	--	----	------

The colours S5 and i4 are made to order. Please enquire about delivery times when ordering.

XX = Colour code to be indicated

01 = White Alpin, R1 = White Alpin CeramicPlus, RW = Stone White CeramicPlus, S5 = Ebony CeramicPlus, i4 = Graphite CeramicPlus

MEMENTO 2.0

€ excl. VAT

Please order tap fittings and soap dispenser separately

WASHBASINS

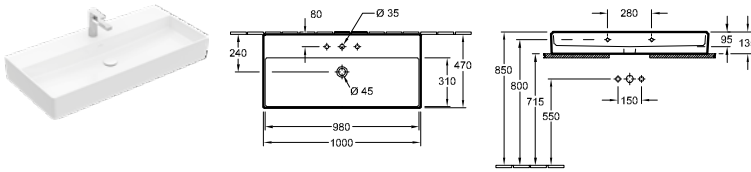

Article number	Description		01	plus R1	plus RW, S5, i4		pcs/ pal.	kg/ pc.
4A22 1G XX	1000 x 470 mm					-	8	29
4A22 1H XX	1000 x 470 mm					-	8	29

ground underside, wall fixation, incl. template, matching furniture programme: Finion, Legato

For further information about matching valves, see pages 380-383

A non-closing valve or the ViFlow (concealed overflow) must be used for models without overflow function.

9221 49 00	WASHBASIN INSTALLATION ELEMENT 525 x 1120 x 75 mm For further ViConnect models, see pages 368-379		-	-	-		10	8,05
------------	--	--	---	---	---	--	----	------

WASHBASINS

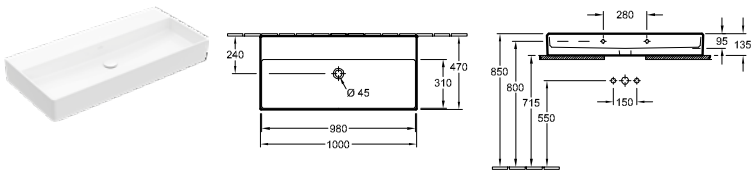

Article number	Description		01	plus R1	plus RW, S5, i4		pcs/ pal.	kg/ pc.
4A22 1F XX	1000 x 470 mm					-	8	29

ground underside, wall fixation, incl. template, when using a wall-mounted tap fitting, we recommend a projection of at least 205 mm, matching furniture programme: Finion, Legato

For further information about matching valves, see pages 380-383

Please note: unclosable outlet valve must be used with models without overflow

9221 49 00	WASHBASIN INSTALLATION ELEMENT 525 x 1120 x 75 mm For further ViConnect models, see pages 368-379		-	-	-		10	8,05
------------	--	--	---	---	---	--	----	------

WASHBASINS

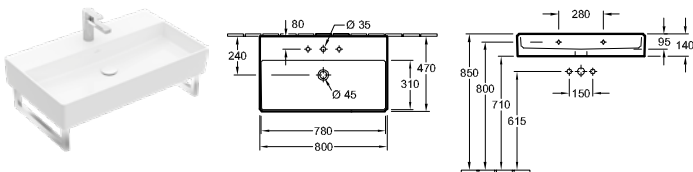

Article number	Description		01	plus R1	plus RW, S5, i4		pcs/ pal.	kg/ pc.
4A22 80 XX	800 x 470 mm					-	12	24,9
4A22 81 XX	800 x 470 mm					-	12	24,9

wall fixation, towel holder (not included in scope of delivery): side installation (mountable: 2 pc.)

For further information about matching valves, see pages 380-383

A non-closing valve or the ViFlow (concealed overflow) must be used for models without overflow function.

8749 42 D7	TOWEL RAIL (optional) 420 x 140 mm, stainless steel, side installation, fastening set included		-	-	-			1,9
9221 49 00	WASHBASIN INSTALLATION ELEMENT 525 x 1120 x 75 mm For further ViConnect models, see pages 368-379		-	-	-		10	8,05

The colours S5 and i4 are made to order. Please enquire about delivery times when ordering.

XX = Colour code to be indicated

01 = White Alpin, R1 = White Alpin CeramicPlus, RW = Stone White CeramicPlus, S5 = Ebony CeramicPlus, i4 = Graphite CeramicPlus

MEMENTO 2.0

€ excl. VAT

Please order tap fittings and soap dispenser separately

WASHBASINS

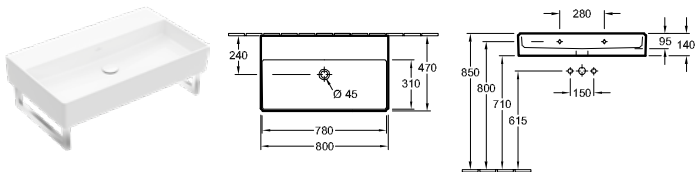

Article number	Description		01	plus R1	plus RW, S5, i4		pcs/ pal.	kg/ pc.
4A22 83 XX	800 x 470 mm					-	12	24,9

wall fixation, towel holder (not included in scope of delivery): side installation (mountable: 2 pc.), when using a wall-mounted tap fitting, we recommend a projection of at least 205 mm

For further information about matching valves, see pages 380-383

Please note: unclosable outlet valve must be used with models without overflow

8749 42 D7	TOWEL RAIL (optional) 420 x 140 mm, stainless steel, side installation, fastening set included		-	-	-			1,9
9221 49 00	WASHBASIN INSTALLATION ELEMENT 525 x 1120 x 75 mm For further ViConnect models, see pages 368-379		-	-	-		10	8,05

WASHBASINS

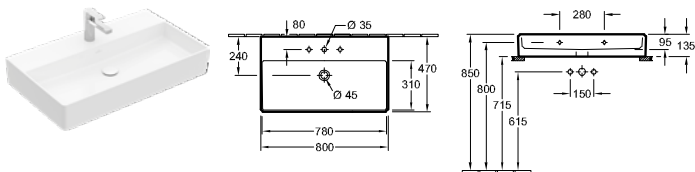

Article number	Description		01	plus R1	plus RW, S5, i4		pcs/ pal.	kg/ pc.
4A22 8G XX	800 x 470 mm					-	12	24,9
4A22 8L XX	800 x 470 mm					-	12	24,9

ground underside, wall fixation, incl. template, matching furniture programme: Finion, Legato

For further information about matching valves, see pages 380-383

A non-closing valve or the ViFlow (concealed overflow) must be used for models without overflow function.

9221 49 00	WASHBASIN INSTALLATION ELEMENT 525 x 1120 x 75 mm For further ViConnect models, see pages 368-379		-	-	-		10	8,05
------------	--	--	---	---	---	--	----	------

WASHBASINS

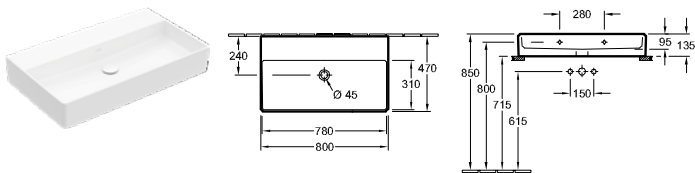

Article number	Description		01	plus R1	plus RW, S5, i4		pcs/ pal.	kg/ pc.
4A22 8F XX	800 x 470 mm					-	12	24,9

ground underside, wall fixation, incl. template, when using a wall-mounted tap fitting, we recommend a projection of at least 205 mm, matching furniture programme: Finion, Legato

For further information about matching valves, see pages 380-383

Please note: unclosable outlet valve must be used with models without overflow

9221 49 00	WASHBASIN INSTALLATION ELEMENT 525 x 1120 x 75 mm For further ViConnect models, see pages 368-379		-	-	-		10	8,05
------------	--	--	---	---	---	--	----	------

The colours S5 and i4 are made to order. Please enquire about delivery times when ordering.

XX = Colour code to be indicated

01 = White Alpin, R1 = White Alpin CeramicPlus, RW = Stone White CeramicPlus, S5 = Ebony CeramicPlus, i4 = Graphite CeramicPlus

MEMENTO 2.0

€ excl. VAT

Please order tap fittings and soap dispenser separately

WASHBASINS

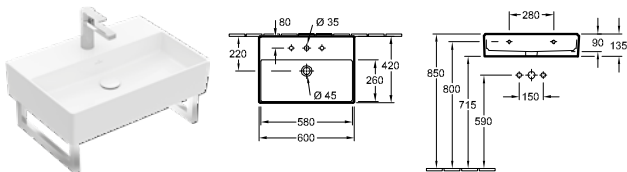

Article number	Description	01	plus R1	plus RW, S5, i4	pcs/ pal.	kg/ pc.
4A22 60 XX	600 x 420 mm				-	10 17,2
4A22 61 XX	600 x 420 mm				-	10 17,2

wall fixation, towel holder (not included in scope of delivery): side installation (mountable: 2 pc.)

For further information about matching valves, see pages 380-383

A non-closing valve or the ViFlow (concealed overflow) must be used for models without overflow function.

8749 37 D7	TOWEL RAIL (optional) 370 x 140 mm, stainless steel, side installation, fastening set included		-	-	-	1,038
9221 49 00	WASHBASIN INSTALLATION ELEMENT 525 x 1120 x 75 mm For further ViConnect models, see pages 368-379		-	-	-	10 8,05

WASHBASINS

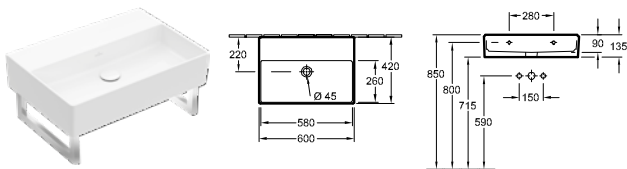

Article number	Description	01	plus R1	plus RW, S5, i4	pcs/ pal.	kg/ pc.
4A22 63 XX	600 x 420 mm				-	10 17,2

wall fixation, towel holder (not included in scope of delivery): side installation (mountable: 2 pc.), when using a wall-mounted tap fitting, we recommend a projection of at least 205 mm

For further information about matching valves, see pages 380-383

Please note: unclosable outlet valve must be used with models without overflow

8749 37 D7	TOWEL RAIL (optional) 370 x 140 mm, stainless steel, side installation, fastening set included		-	-	-	1,038
9221 49 00	WASHBASIN INSTALLATION ELEMENT 525 x 1120 x 75 mm For further ViConnect models, see pages 368-379		-	-	-	10 8,05

The colours S5 and i4 are made to order. Please enquire about delivery times when ordering.

XX = Colour code to be indicated

01 = White Alpin, R1 = White Alpin CeramicPlus, RW = Stone White CeramicPlus, S5 = Ebony CeramicPlus, i4 = Graphite CeramicPlus

MEMENTO 2.0

€ excl. VAT

Please order tap fittings and soap dispenser separately

WASHBASINS

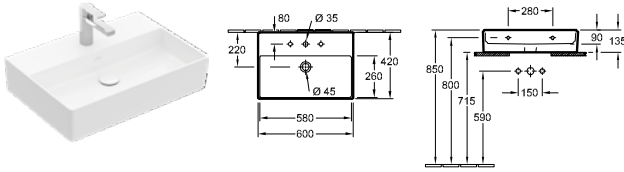

Article number	Description		01	plus R1	plus RW, S5, i4		pcs/ pal.	kg/ pc.
4A22 6G XX	600 x 420 mm					-	10	17,7
4A22 6L XX	600 x 420 mm					-	10	17,7

ground underside, wall fixation, incl. template, matching furniture programme: Finion, Legato

For further information about matching valves, see pages 380-383

A non-closing valve or the ViFlow (concealed overflow) must be used for models without overflow function.

9221 49 00	WASHBASIN INSTALLATION ELEMENT 525 x 1120 x 75 mm For further ViConnect models, see pages 368-379		-	-	-		10	8,05
------------	--	--	---	---	---	--	----	------

WASHBASINS

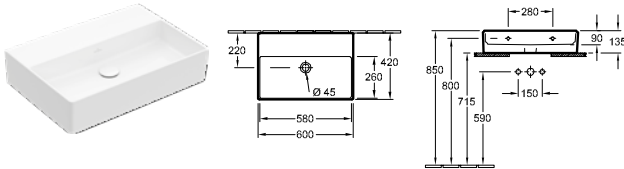

Article number	Description		01	plus R1	plus RW, S5, i4		pcs/ pal.	kg/ pc.
4A22 6F XX	600 x 420 mm					-	10	17,7

ground underside, wall fixation, incl. template, when using a wall-mounted tap fitting, we recommend a projection of at least 205 mm, matching furniture programme: Finion, Legato

For further information about matching valves, see pages 380-383

Please note: unclosable outlet valve must be used with models without overflow

9221 49 00	WASHBASIN INSTALLATION ELEMENT 525 x 1120 x 75 mm For further ViConnect models, see pages 368-379		-	-	-		10	8,05
------------	--	--	---	---	---	--	----	------

WASHBASINS

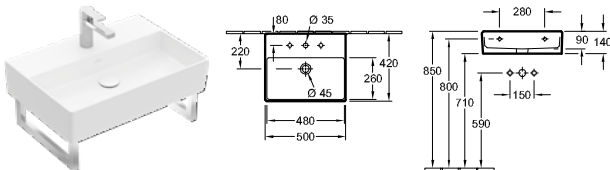

Article number	Description		01	plus R1	plus RW, S5, i4		pcs/ pal.	kg/ pc.
4A22 50 XX	500 x 420 mm					-	12	14,2
4A22 51 XX	500 x 420 mm					-	12	14,19

wall fixation, towel holder (not included in scope of delivery): side installation (mountable: 2 pc.)

For further information about matching valves, see pages 380-383

A non-closing valve or the ViFlow (concealed overflow) must be used for models without overflow function.

8749 37 D7	TOWEL RAIL (optional) 370 x 140 mm, stainless steel, side installation, fastening set included		-	-	-			1,038
9221 49 00	WASHBASIN INSTALLATION ELEMENT 525 x 1120 x 75 mm For further ViConnect models, see pages 368-379		-	-	-		10	8,05

The colours S5 and i4 are made to order. Please enquire about delivery times when ordering.

XX = Colour code to be indicated

01 = White Alpin, R1 = White Alpin CeramicPlus, RW = Stone White CeramicPlus, S5 = Ebony CeramicPlus, i4 = Graphite CeramicPlus

MEMENTO 2.0

€ excl. VAT

Please order tap fittings and soap dispenser separately

WASHBASINS

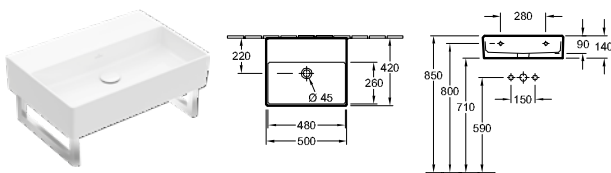

Article number	Description		01	plus R1	plus RW, S5, i4		pcs/ pal.	kg/ pc.
4A22 53 XX	500 x 420 mm	Titan Ceramic				-	12	14,19

wall fixation, towel holder (not included in scope of delivery): side installation (mountable: 2 pc.), when using a wall-mounted tap fitting, we recommend a projection of at least 205 mm

For further information about matching valves, see pages 380-383

Please note: unclosable outlet valve must be used with models without overflow

8749 37 D7	TOWEL RAIL (optional) 370 x 140 mm, stainless steel, side installation, fastening set included		-	-	-			1,038
9221 49 00	WASHBASIN INSTALLATION ELEMENT 525 x 1120 x 75 mm For further ViConnect models, see pages 368-379		-	-	-		10	8,05

WASHBASINS

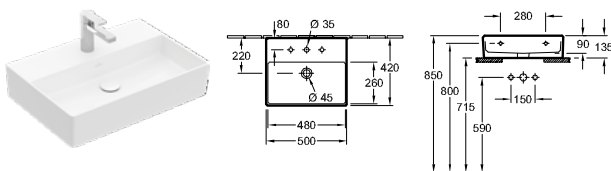

Article number	Description		01	plus R1	plus RW, S5, i4		pcs/ pal.	kg/ pc.
4A22 5G XX	500 x 420 mm	Titan Ceramic				-	12	13,1
4A22 5L XX	500 x 420 mm	Titan Ceramic				-	12	13,1

ground underside, wall fixation, incl. template, matching furniture programme: Finion, Legato

For further information about matching valves, see pages 380-383

A non-closing valve or the ViFlow (concealed overflow) must be used for models without overflow function.

9221 49 00	WASHBASIN INSTALLATION ELEMENT 525 x 1120 x 75 mm For further ViConnect models, see pages 368-379		-	-	-		10	8,05
------------	---	--	---	---	---	--	----	------

WASHBASINS

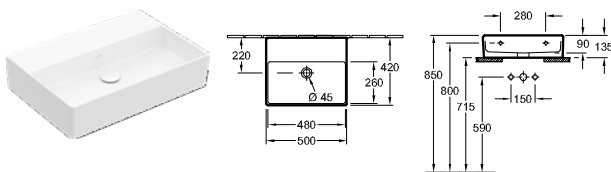

Article number	Description		01	plus R1	plus RW, S5, i4		pcs/ pal.	kg/ pc.
4A22 5F XX	500 x 420 mm	Titan Ceramic				-	12	13,1

ground underside, wall fixation, incl. template, when using a wall-mounted tap fitting, we recommend a projection of at least 205 mm, matching furniture programme: Finion, Legato

For further information about matching valves, see pages 380-383

Please note: unclosable outlet valve must be used with models without overflow

9221 49 00	WASHBASIN INSTALLATION ELEMENT 525 x 1120 x 75 mm For further ViConnect models, see pages 368-379		-	-	-		10	8,05
------------	---	--	---	---	---	--	----	------

The colours S5 and i4 are made to order. Please enquire about delivery times when ordering.

XX = Colour code to be indicated

01 = White Alpin, R1 = White Alpin CeramicPlus, RW = Stone White CeramicPlus, S5 = Ebony CeramicPlus, i4 = Graphite CeramicPlus

MEMENTO 2.0

MEMENTO 2.0

€ excl. VAT

Please order tap fittings and soap dispenser separately

SURFACE-MOUNTED WASHBASIN

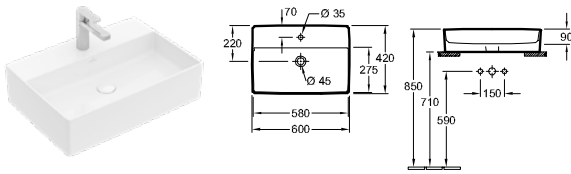

Article number	Description		01	plus R1	plus RW, S5, i4		pcs/ pal.	kg/ pc.
4A07 60 XX	600 x 420 mm	Titan Ceram				-	10	17,6
4A07 61 XX	600 x 420 mm	Titan Ceram				-	10	17,6

Recommendation: to be installed with a gap of at least 50 mm between the washbasin and the wall, fastening set included, incl. template, matching furniture programme: Finion, Legato
For further information about matching valves, see pages 380-383

A non-closing valve or the ViFlow (concealed overflow) must be used for models without overflow function.

SURFACE-MOUNTED WASHBASIN

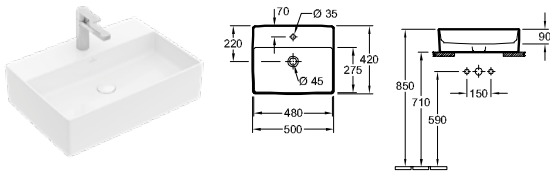

Article number	Description		01	plus R1	plus RW, S5, i4		pcs/ pal.	kg/ pc.
4A07 50 XX	500 x 420 mm	Titan Ceram				-	12	14,7
4A07 51 XX	500 x 420 mm	Titan Ceram				-	12	14,7

Recommendation: to be installed with a gap of at least 50 mm between the washbasin and the wall, fastening set included, incl. template
For further information about matching valves, see pages 380-383

A non-closing valve or the ViFlow (concealed overflow) must be used for models without overflow function.

HANDWASHBASIN

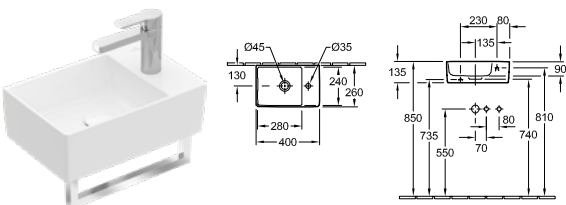

Article number	Description		01	plus R1	plus RW, S5, i4		pcs/ pal.	kg/ pc.
4323 40 XX	400 x 260 mm	Titan Ceram				-	56	7,7

wall fixation, towel holder (not included in scope of delivery): front installation

For further information about matching valves, see pages 380-383

Please note: unclosable outlet valve must be used with models without overflow

8749 34 D7	TOWEL RAIL (optional) 345 x 100 mm, stainless steel, front installation, fastening set included		-	-	-			1,025
------------	--	--	---	---	---	--	--	-------

The colours S5 and i4 are made to order. Please enquire about delivery times when ordering.

XX = Colour code to be indicated

01 = White Alpin, R1 = White Alpin CeramicPlus, RW = Stone White CeramicPlus, S5 = Ebony CeramicPlus, i4 = Graphite CeramicPlus



MEMENTO 2.0

€ excl. VAT

Please order tap fittings and soap dispenser separately

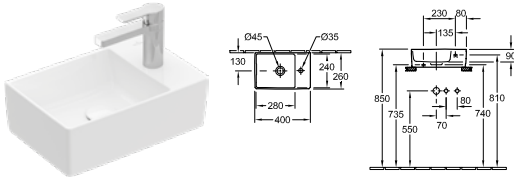
HANDWASHBASIN



Article number	Description	01	plus R1	plus RW, S5, i4	pcs/ pal.	kg/ pc.
4323 4G XX	400 x 260 mm  				-	56 7.7

ground underside, wall fixation, incl. template



For further information about matching valves, see pages 380-383

Please note: unclosable outlet valve must be used with models without overflow

BIDET

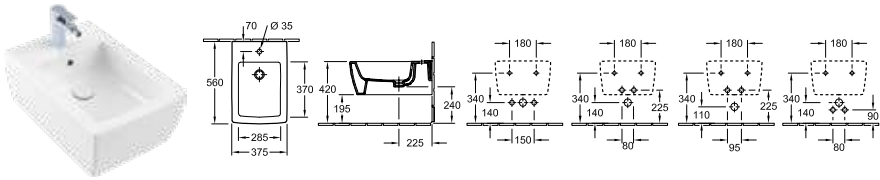
Registered design





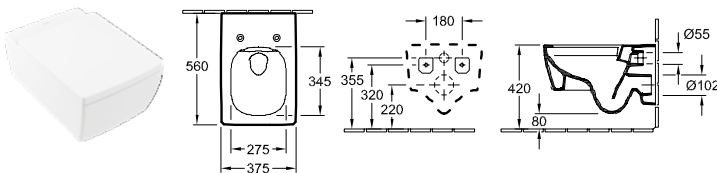

Article number	Description	01	plus R1	plus RW, S5, i4	pcs/ pal.	kg/ pc.
4433 00 XX	375 x 560 mm  				-	12 21.9
9953 00 00	FASTENING FRAME (optional)	-	-	-		2.93
9221 48 00	BIDET INSTALLATION SYSTEM 525 x 1120 x 100 mm For further ViConnect models, see pages 368-379		-	-	-	10 10.54

WASHDOWN TOILET, RIMLESS

DirectFlush, Registered design



Article number	Description	01	plus R1	plus RW, S5, i4	pcs/ pal.	kg/ pc.
4633 R0 XX	375 x 560 mm	  			-	12 24.4
8M24 S1 XX	TOILET SEAT AND COVER with QuickRelease and SoftClosing hinges, hinges in stainless steel		-	-	-	2,935
9222 87 00	VIPROTECT SOUNDPROOFING SET (optional) incl. accessories		-	-	-	600 0,086
9224 65 00	TOILET INSTALLATION SYSTEM for dry-wall construction, low 450 x 1120 x 165 mm For further ViConnect models, see pages 368-379		-	-	-	8 19.78
9224 27 00	TOILET INSTALLATION SYSTEM for dry-wall construction, standard height 525 x 1120 x 135 mm For further ViConnect models, see pages 368-379		-	-	-	10 15.8

The colours S5 and i4 are made to order. Please enquire about delivery times when ordering.

XX = Colour code to be indicated

01 = White Alpin, R1 = White Alpin CeramicPlus, RW = Stone White CeramicPlus, S5 = Ebony CeramicPlus, i4 = Graphite CeramicPlus

MEMENTO 2.0

€ excl. VAT

Please order tap fittings and soap dispenser separately

SIPHONIC URINAL



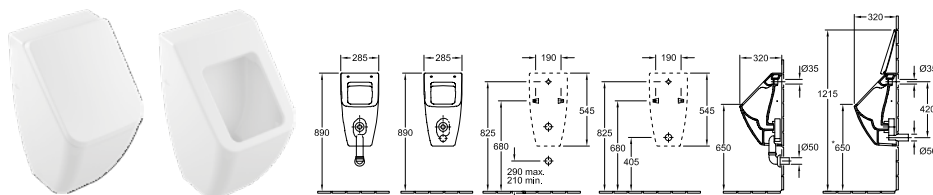

DirectFlush

We recommend the urinal from VENTICELLO for use with MEMENTO 2.0



Article number	Description	01	R1	plus RW, S5, i4	pcs/ pal.	kg/ pc.
5504 R1 XX	285 x 545 x 315 mm for cover	Direct Flush			-	15 17
5504 R0 XX	285 x 545 x 315 mm without cover	Direct Flush			-	15 17

with fastening set for concealed fastening, concealed water inlet, Outlet may be concealed depending on the type of extractor section

8M10 S1 XX	COVER with SoftClosing hinges, chrome hinges		-	-	-	240 1,3
9326 00 00	EXTRACTOR (optional) horizontal outlet, Flush volume: 1,0 l		-	-	-	0,164
9327 00 00	EXTRACTOR (optional) vertical outlet, Flush volume: 1,0 l		-	-	-	0,175
9319 00 00	CONNECTION PIECES (optional) comprising: collar, outlet elbow, drain pipe 150 mm long		-	-	-	0,232
9933 00 00	WATER-INLET CONNECTOR (optional)		-	-	-	0,2
9190 B1 00	PRODETECT 2 RADAR FLUSH CONTROL FOR URINALS (optional) electronic urinal flushing system, battery-operated (6 x 1.5 V AAA required), pipe thread inlet connector 1/2"	Pro Detect 2	-	-	-	0,974
9190 N1 00	PRODETECT 2 RADAR FLUSH CONTROL FOR URINALS (optional) electronic urinal flushing system, mains-powered (110 - 240 V), Bluetooth-compatible thanks to optional adapter, pipe thread inlet connector 1/2"	Pro Detect 2	-	-	-	1,006
9190 61 00	BLUETOOTH ADAPTER (optional) Bluetooth-adapter for 9190 N1 for wireless function change and maintenance, incl. free app for iOS and Android, suitable for smartphones and tablets	Pro Detect 2	-	-	-	0,03
9190 57 00	ADAPTER FOR MAINS POWER SUPPLY CONNECTION (optional) recommendation: to install with power supply unit 9190 N1 00	Pro Detect 2	-	-	-	0,038
9221 85 00	URINAL INSTALLATION SYSTEM FOR PRODETECT 525 x 1120 x 80 mm For further ViConnect models, see pages 368-379		-	-	-	10 7,15
9219 89 00	URINAL INSTALLATION SYSTEM 525 x 1120 x 98 mm For further ViConnect models, see pages 368-379		-	-	-	8,05

The colours S5 and i4 are made to order. Please enquire about delivery times when ordering.

XX = Colour code to be indicated

01 = White Alpin, R1 = White Alpin CeramicPlus, RW = Stone White CeramicPlus, S5 = Ebony CeramicPlus, i4 = Graphite CeramicPlus

MORE TO SEE

Bathroom furniture

- Mainstream segment
- Match all collections/furniture programmes

[PRO.VILLEROY-BOCH.COM/TECHNICALDRAWINGS](https://pro.villeroy-boch.com/technicaldrawings)



MORE TO SEE

€ excl. VAT

Registered design

Goods in stock

 These products are always in stock.

Mirrors:











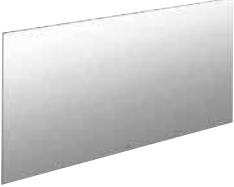

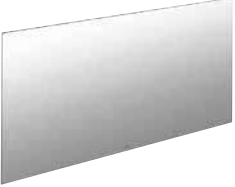

mirror with lighting (5 mm) on a frame
mirror without lighting (5 mm), 2 hangers (without supporting frame)

Mirror frame:

60 mm x 40 mm aluminium frame (hollow profile, matt anodised silver)

Lighting:

LED lighting with chrome-plated, glossy metal casing
light colour in daylight white (5700 K)
for room/outside light switch
loose mains connection

	MIRROR	MIRROR	MIRROR	MIRROR
				
				
Article number	A310 16 00	A310 14 00	A310 13 00	A310 12 00
Dimensions (w x h x d)	1600 x 750 x 20 mm	1400 x 750 x 20 mm	1300 x 750 x 20 mm	1200 x 750 x 20 mm
Scope of delivery	fastening set included	fastening set included	fastening set included	fastening set included
	MIRROR	MIRROR	MIRROR	MIRROR
				
				
Article number	A310 10 00	A310 90 00	A310 80 00	A310 70 00
Dimensions (w x h x d)	1000 x 750 x 20 mm	900 x 750 x 20 mm	800 x 750 x 20 mm	700 x 750 x 20 mm
Scope of delivery	fastening set included	fastening set included	fastening set included	fastening set included
	MIRROR	MIRROR	MIRROR	MIRROR
				
				
Article number	A310 65 00	A310 60 00	A310 55 00	A310 50 00
Dimensions (w x h x d)	650 x 750 x 20 mm	600 x 750 x 20 mm	550 x 750 x 20 mm	500 x 750 x 20 mm
Scope of delivery	fastening set included	fastening set included	fastening set included	fastening set included

MORE TO SEE

€ excl. VAT



Registered design

Goods in stock

Express Delivery These products are always in stock.

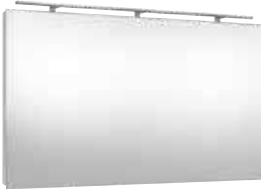
	MIRROR
	
	Express Delivery
Article number	A310 45 00
Dimensions (w x h x d)	450 x 750 x 20 mm
Scope of delivery	fastening set included

	MIRROR	MIRROR	MIRROR	MIRROR
				
	Express Delivery	Express Delivery	Express Delivery	Express Delivery
Article number	A404 16 00	A404 14 00	A404 13 00	A404 12 00
Dimensions (w x h x d)	1600 x 750 x 126/130 mm	1400 x 750 x 126/130 mm	1300 x 750 x 126/130 mm	1200 x 750 x 126/130 mm
Lighting	LED lighting Lighting 1x LED / 12 W	LED lighting Lighting 1x LED / 12 W	LED lighting Lighting 1x LED / 10 W	LED lighting Lighting 1x LED / 10 W
Equipped with	1x lamp	1x lamp	1x lamp	1x lamp
Note on standard	IP 44	IP 44	IP 44	IP 44
Scope of delivery	fastening set included	fastening set included	fastening set included	fastening set included

	MIRROR	MIRROR	MIRROR	MIRROR
				
	Express Delivery	Express Delivery	Express Delivery	Express Delivery
Article number	A404 10 00	A404 90 00	A404 80 00	A404 70 00
Dimensions (w x h x d)	1000 x 750 x 126/130 mm	900 x 750 x 126/130 mm	800 x 750 x 126/130 mm	700 x 750 x 126/130 mm
Lighting	LED lighting Lighting 1x LED / 8 W	LED lighting Lighting 1x LED / 8 W	LED lighting Lighting 1x LED / 8 W	LED lighting Lighting 1x LED / 6 W
Equipped with	1x lamp	1x lamp	1x lamp	1x lamp
Note on standard	IP 44	IP 44	IP 44	IP 44
Scope of delivery	fastening set included	fastening set included	fastening set included	fastening set included

MORE TO SEE

MORE TO SEE





€ excl. VAT

Registered design

Goods in stock

 Express
Delivery

These products are always in stock.

	MIRROR	MIRROR	MIRROR	MIRROR
				
				
Article number	A404 65 00	A404 60 00	A404 55 00	A404 50 00
Dimensions (w x h x d)	650 x 750 x 126/130 mm	600 x 750 x 126/130 mm	550 x 750 x 126/130 mm	500 x 750 x 126/130 mm
Lighting	LED lighting Lighting 1x LED / 6 W	LED lighting Lighting 1x LED / 6 W	LED lighting Lighting 1x LED / 6 W	LED lighting Lighting 1x LED / 4 W
Equipped with	1x lamp	1x lamp	1x lamp	1x lamp
Note on standard	IP 44	IP 44	IP 44	IP 44
Scope of delivery	fastening set included	fastening set included	fastening set included	fastening set included

MORE TO SEE 14

Bathroom furniture

- Mainstream segment
- Match all collections/furniture programmes

[PRO.VILLEROY-BOCH.COM/TECHNICALDRAWINGS](https://pro.villeroy-boch.com/technicaldrawings)



MORE TO SEE 14

€ excl. VAT

Goods in stock

Express Delivery These products are always in stock.

Mirrors:

mirror (5 mm) on a frame
 available with sound system with wireless transmission
 Can be combined with all Bluetooth-compatible devices, such as MP3 players and smart-phones
 Supply voltage: 100...240 VAC
 Loudspeaker outputs: 2 x 10 W (stereo)
 Loudspeaker impedance: channel L/R: 2 x 4 Ohm
 SUB: 8 Ohm (2.1 sound system)
 Frequency range: 100-18.000 Hz
 Bluetooth standards: Bluetooth CSR 3.0













Maximum distance between transmitter and receiver: 10 m

Mirror frame:

40 mm x 40 mm aluminium frame (hollow profile, matt anodised silver)

Lighting:

integrated horizontal LED lighting
 3 dimmer settings
 freely-adjustable light colour from DaylightWhite (6500 kelvin) to WarmWhite (2700 kelvin)
 sensor switch with orientation light
 auto-on function – when switching on, the light intensity is always 100%, the colour temperature remains pre-set
 loose mains connection







	MIRROR	MIRROR	MIRROR	MIRROR
				
				
Article number	A429 16 00	A429 14 00	A429 13 00	A429 12 00
Dimensions (w x h x d)	1600 x 750 x 47 mm	1400 x 750 x 47 mm	1300 x 750 x 47 mm	1200 x 750 x 47 mm
Lighting	LED lighting Lighting 1x LED / 23,3 W	LED lighting Lighting 1x LED / 20,2 W	LED lighting Lighting 1x LED / 18,6 W	LED lighting Lighting 1x LED / 17,1 W
Note on standard	IP 44	IP 44	IP 44	IP 44
Scope of delivery	fastening set included	fastening set included	fastening set included	fastening set included
	MIRROR	MIRROR	MIRROR	MIRROR
				
				
Article number	A429 10 00	A429 90 00	A429 80 00	A429 70 00
Dimensions (w x h x d)	1000 x 750 x 47 mm	900 x 750 x 47 mm	800 x 750 x 47 mm	700 x 750 x 47 mm
Lighting	LED lighting Lighting 1x LED / 14 W	LED lighting Lighting 1x LED / 12,4 W	LED lighting Lighting 1x LED / 10,9 W	LED lighting Lighting 1x LED / 9,3 W
Note on standard	IP 44	IP 44	IP 44	IP 44
Scope of delivery	fastening set included	fastening set included	fastening set included	fastening set included















MORE TO SEE 14















€ excl. VAT

Goods in stock

Express Delivery These products are always in stock.

	MIRROR	MIRROR	MIRROR	MIRROR
				
				
Article number	A429 60 00	A429 50 00	A429 45 00	A429 37 00
Dimensions (w x h x d)	600 x 750 x 47 mm	500 x 750 x 47 mm	450 x 750 x 47 mm	370 x 750 x 47 mm
Lighting	LED lighting Lighting 1x LED / 7,8 W	LED lighting Lighting 1x LED / 6,2 W	LED lighting Lighting 1x LED / 5,4 W	LED lighting Lighting 1x LED / 3,9 W
Note on standard	IP 44	IP 44	IP 44	IP 44
Scope of delivery	fastening set included	fastening set included	fastening set included	fastening set included

	MIRROR	MIRROR	MIRROR	MIRROR
				
	  	  	  	  
Article number	A432 16 00	A432 14 00	A432 13 00	A432 12 00
Dimensions (w x h x d)	1600 x 750 x 47 mm	1400 x 750 x 47 mm	1300 x 750 x 47 mm	1200 x 750 x 47 mm
Lighting	LED lighting Lighting 1x LED / 23,3 W	LED lighting Lighting 1x LED / 20,2 W	LED lighting Lighting 1x LED / 18,6 W	LED lighting Lighting 1x LED / 17,1 W
Equipped with	Sound system with Bluetooth® wireless transmission	Sound system with Bluetooth® wireless transmission	Sound system with Bluetooth® wireless transmission	Sound system with Bluetooth® wireless transmission
Note on standard	IP 44	IP 44	IP 44	IP 44
Scope of delivery	fastening set included	fastening set included	fastening set included	fastening set included

	MIRROR	MIRROR	MIRROR	MIRROR
				
	  	  	  	  
Article number	A432 10 00	A432 90 00	A432 80 00	A432 70 00
Dimensions (w x h x d)	1000 x 750 x 47 mm	900 x 750 x 47 mm	800 x 750 x 47 mm	700 x 750 x 47 mm
Lighting	LED lighting Lighting 1x LED / 14 W	LED lighting Lighting 1x LED / 12,4 W	LED lighting Lighting 1x LED / 10,9 W	LED lighting Lighting 1x LED / 10,9 W
Equipped with	Sound system with Bluetooth® wireless transmission	Sound system with Bluetooth® wireless transmission	Sound system with Bluetooth® wireless transmission	Sound system with Bluetooth® wireless transmission
Note on standard	IP 44	IP 44	IP 44	IP 44
Scope of delivery	fastening set included	fastening set included	fastening set included	fastening set included

MORE TO SEE 14

€ excl. VAT

Goods in stock

Express Delivery These products are always in stock.

	MIRROR
	
	<div style="display: flex; gap: 5px;"> <div style="border: 1px solid black; padding: 2px;">Express Delivery</div> <div style="border: 1px solid black; padding: 2px;">*Sound</div> <div style="border: 1px solid black; padding: 2px;">Bluetooth</div> </div>
Article number	A432 60 00
Dimensions (w x h x d)	600 x 750 x 47 mm
Lighting	LED lighting Lighting 1x LED / 7,8 W
Equipped with	Sound system with Bluetooth® wireless transmission
Note on standard	IP 44
Scope of delivery	fastening set included

MORE TO SEE LITE

NEW

Bathroom furniture

- Mainstream segment
- Match all collections/furniture programmes

PRO.VILLEROY-BOCH.COM/TECHNICALDRAWINGS



MORE TO SEE LITE

NEW

€ excl. VAT

Express Delivery These products are always in stock.

Mirrors:

Mirror (4 mm) on a frame

Mirror frame:

Illuminated mirror, square: plastic profile, 33 mm x 19 mm

Illuminated mirror, round: aluminium profile, 9 mm x 25 mm

Illuminated mirror, with rounded corners: plastic profile, 33 mm x 19 mm

Sheet metal mounting

Lighting:

with all-round LED lighting

continuously dimmable

freely-adjustable light colour from DaylightWhite (6500 kelvin) to WarmWhite (2700 kelvin)

Light control via sensor switch by touching the logo on the mirror surface or smart light control with ZIGBEE HOME AUTOMATION KIT C004 00 00 (The mirror can be connected via the Zigbee Home Automation Standard with all hubs/gateways that use this transmission standard, such as Philips Hue Bridge or suitable Amazon Echo models).

Memory feature - The lighting readjusts to the intensity and colour temperature that were set before the power was switched off.







	MIRROR	MIRROR	MIRROR	MIRROR
Article number	A459 16 00	A459 14 00	A459 13 00	A459 12 00
Dimensions (w x h x d)	1600 x 750 x 24 mm	1400 x 750 x 24 mm	1300 x 750 x 24 mm	1200 x 750 x 24 mm
Lighting	with all-round LED wall lighting (replaceable) Lighting 1x 41,76 W	with all-round LED wall lighting (replaceable) Lighting 1x 37,92 W	with all-round LED wall lighting (replaceable) Lighting 1x LED / 36 W	with all-round LED wall lighting (replaceable) Lighting 1x 34,08 W
Note on standard	IP 44	IP 44	IP 44	IP 44
Scope of delivery	fastening set included	fastening set included	fastening set included	fastening set included
	MIRROR	MIRROR	MIRROR	MIRROR
Article number	A459 10 00	A459 80 00	A459 65 00	A459 60 00
Dimensions (w x h x d)	1000 x 750 x 24 mm	800 x 750 x 24 mm	650 x 750 x 24 mm	600 x 750 x 24 mm
Lighting	with all-round LED wall lighting (replaceable) Lighting 1x 30,24 W	with all-round LED wall lighting (replaceable) Lighting 1x 26,40 W	with all-round LED wall lighting (replaceable) Lighting 1x 23,52 W	with all-round LED wall lighting (replaceable) Lighting 1x 22,56 W
Note on standard	IP 44	IP 44	IP 44	IP 44
Scope of delivery	fastening set included	fastening set included	fastening set included	fastening set included





MORE TO SEE LITE







NEW

€ excl. VAT

Express Delivery These products are always in stock.

	MIRROR	MIRROR	MIRROR
			
			
Article number	A459 50 00	A459 45 00	A459 37 00
Dimensions (w x h x d)	500 x 750 x 24 mm	450 x 750 x 24 mm	370 x 750 x 24 mm
Lighting	with all-round LED wall lighting (replaceable) Lighting 1x 20,64 W	with all-round LED wall lighting (replaceable) Lighting 1x 19,68 W	with all-round LED wall lighting (replaceable) Lighting 1x 18,24 W
Note on standard	IP 44	IP 44	IP 44
Scope of delivery	fastening set included	fastening set included	fastening set included

	MIRROR	MIRROR
		
		
Article number	A460 85 00	A460 68 00
Dimensions (w x h x d)	850 x 850 x 31 mm	650 x 650 x 31 mm
Lighting	with all-round LED lighting (cannot be replaced) Lighting 1x 23,52 W	with all-round LED lighting (cannot be replaced) Lighting 1x 17,28 W
Note on standard	IP 44	IP 44
Scope of delivery	fastening set included	fastening set included



	MIRROR	MIRROR	MIRROR
			
			
Article number	A461 10 00	A462 80 00	A462 60 00
Dimensions (w x h x d)	600 x 1000 x 24 mm	800 x 800 x 24 mm	600 x 600 x 24 mm
Lighting	with all-round LED wall lighting (replaceable) Lighting 1x 26,88 W	with all-round LED wall lighting (replaceable) Lighting 1x 26,88 W	with all-round LED wall lighting (replaceable) Lighting 1x 19,20 W
Note on standard	IP 44	IP 44	IP 44
Scope of delivery	fastening set included	fastening set included	fastening set included

MORE TO SEE LITE

NEW

€ excl. VAT

Express Delivery These products are always in stock.

	ZIGBEE® HOME AUTOMATION KIT FOR MIRRORS
	
	
Article number	C004 00 00
Scope of delivery	not included in scope of delivery

MORE TO SEE ONE

Bathroom furniture

- Profi segment
- Match all collections/furniture programmes

[PRO.VILLEROY-BOCH.COM/TECHNICALDRAWINGS](https://pro.villeroy-boch.com/technicaldrawings)



MORE TO SEE
ONE



MORE TO SEE ONE





€ excl. VAT



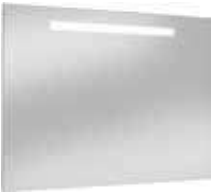

Goods in stock

Express Delivery These products are always in stock.

Mirrors:
mirror (5 mm) on a frame
Mirror frame:
30 mm x 20 mm aluminium frame (L-profile, matt anodised)
Lighting:

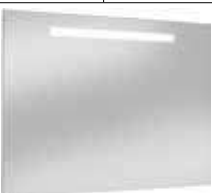
integrated horizontal LED lighting
LED can be replaced
light colour in daylight white (5700 K)
for room/outside light switch
loose mains connection

	MIRROR	MIRROR	MIRROR	MIRROR
				
				
Article number	A430 A1 00	A430 A2 00	A430 A3 00	A430 A4 00
Dimensions (w x h x d)	1400 x 600 x 30 mm	1300 x 600 x 30 mm	1200 x 600 x 30 mm	1000 x 600 x 30 mm
Lighting	LED lighting Lighting 1x LED / 12 W	LED lighting Lighting 1x LED / 12 W	LED lighting Lighting 1x LED / 12 W	LED lighting Lighting 1x LED / 12 W
Note on standard	IP 44	IP 44	IP 44	IP 44
Scope of delivery	fastening set included	fastening set included	fastening set included	fastening set included

	MIRROR	MIRROR	MIRROR	MIRROR
				
				
Article number	A430 A5 00	A430 A6 00	A430 A7 00	A430 A8 00
Dimensions (w x h x d)	800 x 600 x 30 mm	600 x 600 x 30 mm	500 x 600 x 30 mm	450 x 600 x 30 mm
Lighting	LED lighting Lighting 1x LED / 10 W	LED lighting Lighting 1x LED / 6 W	LED lighting Lighting 1x LED / 6 W	LED lighting Lighting 1x LED / 6 W
Note on standard	IP 44	IP 44	IP 44	IP 44
Scope of delivery	fastening set included	fastening set included	fastening set included	fastening set included

MY VIEW 14

Bathroom furniture

- Mainstream segment
- Match all collections/furniture programmes

PRO.VILLEROY-BOCH.COM/TECHNICALDRAWINGS



MY VIEW 14

MY VIEW 14

€ excl. VAT

Goods in stock

Express Delivery







These products are always in stock.



Front:
mirrored glass on both sides (3 mm) on melamine-coated chipboard (12 mm)

Body:
Aluminium, mirrored at the side (3 mm mirror)
interior colour Aluminium, anodised silver

Lighting:
integrated vertical LED lighting

3 dimmer settings
freely-adjustable light colour from DaylightWhite (6500 kelvin) to WarmWhite (2700 kelvin)
sensor switch
auto-on function – when switching on, the light intensity is always 100%, the colour temperature remains pre-set
washbasin lighting integrated in the door
loose mains connection

	SURFACE-MOUNTED MIRROR CABINET	SURFACE-MOUNTED MIRROR CABINET	SURFACE-MOUNTED MIRROR CABINET	SURFACE-MOUNTED MIRROR CABINET
				
				
Article number	A424 13 00	A423 12 00	A422 10 00	A421 80 00
Dimensions (w x h x d)	1300 x 750 x 173 mm	1200 x 750 x 173 mm	1000 x 750 x 173 mm	800 x 750 x 173 mm
Lighting	LED lighting Lighting 2x LED / 27,96 W	LED lighting Lighting 2x LED / 27,18 W	LED lighting Lighting 2x LED / 26,4 W	LED lighting Lighting 2x LED / 24,84 W
Equipped with	3x door 4x glass shelf 1x shelf 1x magnifying mirror 1x magnetic strip 2x socket sensor switch	3x door 4x glass shelf 1x shelf 1x magnifying mirror 1x magnetic strip 2x socket sensor switch	2x door 4x glass shelf 1x shelf 1x magnifying mirror 1x magnetic strip sensor switch and socket	2x door 2x glass shelf 1x shelf 1x magnifying mirror 1x magnetic strip sensor switch and socket
Note on standard	IP 44	IP 44	IP 44	IP 44
Please note	Mounted on the wall	Mounted on the wall	Mounted on the wall	Mounted on the wall
Scope of delivery	fastening set included	fastening set included	fastening set included	fastening set included

	SURFACE-MOUNTED MIRROR CABINET
	
	
Article number	A420 60 00
Dimensions (w x h x d)	600 x 750 x 173 mm
Lighting	LED lighting Lighting 2x LED / 23,28 W
Equipped with	2x door 2x glass shelf 1x shelf 1x magnifying mirror 1x magnetic strip sensor switch and socket
Note on standard	IP 44
Please note	Mounted on the wall
Scope of delivery	fastening set included

MY VIEW 14+

Bathroom furniture

- Mainstream segment
- Match all collections/furniture programmes

[PRO.VILLEROY-BOCH.COM/TECHNICALDRAWINGS](https://pro.villeroy-boch.com/technicaldrawings)



MY VIEW 14+

MY VIEW 14+

€ excl. VAT

Goods in stock

Express Delivery These products are always in stock.

Front:
mirrored glass on both sides (3 mm) on melamine-coated chipboard (12 mm)
Body:
Aluminium, mirrored at the side (3 mm mirror)
interior colour Aluminium, anodised silver
Lighting:
integrated vertical LED lighting

3 dimmer settings
freely-adjustable light colour from DaylightWhite (6500 kelvin) to WarmWhite (2700 kelvin)
sensor switch
auto-on function – when switching on, the light intensity is always 100%, the colour temperature remains pre-set
washbasin lighting integrated in the door
loose mains connection

	SURFACE-MOUNTED MIRROR CABINET	SURFACE-MOUNTED MIRROR CABINET	SURFACE-MOUNTED MIRROR CABINET	SURFACE-MOUNTED MIRROR CABINET
Article number	A433 13 00	A433 12 00	A433 10 00	A433 80 00
Dimensions (w x h x d)	1300 x 750 x 173 mm	1200 x 750 x 173 mm	1000 x 750 x 173 mm	800 x 750 x 173 mm
Lighting	LED lighting Lighting 2x LED / 27,96 W	LED lighting Lighting 2x LED / 27,18 W	LED lighting Lighting 2x LED / 26,4 W	LED lighting Lighting 2x LED / 24,84 W
Equipped with	3x door 4x glass shelf with rail 1x magnetic strip 1x magnifying mirror 2x socket sensor switch lockable medicine box 6x partition 2x rail 6x label	3x door 4x glass shelf with rail 1x magnetic strip 1x magnifying mirror 2x socket sensor switch lockable medicine box 6x partition 2x rail 6x label	2x door 4x glass shelf with rail 1x magnetic strip 1x magnifying mirror sensor switch and socket lockable medicine box 6x partition 2x rail 6x label	2x door 2x glass shelf with rail 1x magnetic strip 1x magnifying mirror sensor switch and socket lockable medicine box 4x partition 1x rail 6x label
Note on standard	IP 44	IP 44	IP 44	IP 44
Please note	Mounted on the wall	Mounted on the wall	Mounted on the wall	Mounted on the wall
Scope of delivery	fastening set included	fastening set included	fastening set included	fastening set included

MY VIEW 14+

MY VIEW 14+

€ excl. VAT

Goods in stock

Express Delivery These products are always in stock.

	SURFACE-MOUNTED MIRROR CABINET
	
	Express Delivery
Article number	A433 60 00
Dimensions (w x h x d)	600 x 750 x 173 mm
Lighting	LED lighting Lighting 2x LED / 23,28 W
Equipped with	2x door 2x glass shelf with rail 1x magnetic strip 1x magnifying mirror sensor switch and socket lockable medicine box 4x partition 1x rail 6x label
Note on standard	IP 44
Please note	Mounted on the wall
Scope of delivery	fastening set included

MY VIEW NOW

NEW

Bathroom furniture

- Mainstream segment
- Match all collections/furniture programmes

PRO.VILLEROY-BOCH.COM/TECHNICALDRAWINGS



MY VIEW NOW



MY VIEW NOW

NEW

Bathroom furniture

Lighting control

The My View Now lighting control is available in two different variants:



Lighting control via sensor switch:

The lighting is controlled entirely via a sensor switch at the centre of the lower LED strip. The LED lighting is continuously dimmable. The light colour is freely-adjustable, from daylight white to warm white.



Smarte lighting control:

The mirror cabinet can be connected via the Zigbee Home Automation Standard with all hubs/gateways that use this form of transmission, such as Philips Hue Bridge, Amazon Echo Show or Echo Plus (2nd generation). The LED lighting is continuously dimmable. The light colour is freely-adjustable, from daylight white to warm white. There is an additional On/Off switch on the sensor at the centre of the lower LED strip.

Types of installation

My View Now can now be installed in two different ways:

Surface-mounted installation

- The mirror cabinet is attached to the wall.

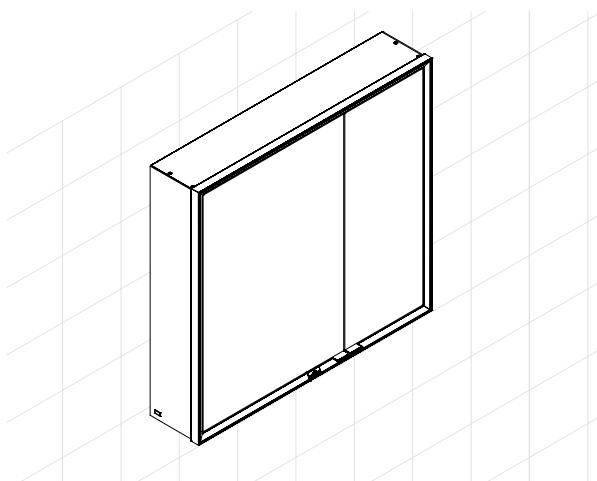

Recessed installation

- The mirror cabinet is installed in a recess in the wall.

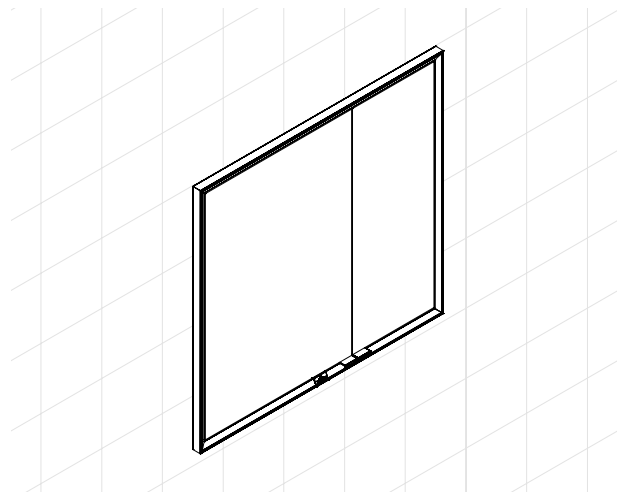

MY VIEW NOW

NEW

€ excl. VAT

Express Delivery These products are always in stock.

Front:
Crystal double mirror doors (2 x 3 mm)
Body:
Surface-mounted mirror cabinet: Aluminium, mirrored at the side (3 mm mirror)
Built-in mirror cabinet: Aluminium
Interior body:
aluminium
Rear panel, white matt, direct-laminated
Handles:
Finish Natural Aluminium (matt)
Interior compartments :

Height-adjustable shelves (aluminium) with rim
Lighting:
Integral all-round LED lighting (can be replaced)
Lighting control via sensor switch on outside or smart lighting control (ZigBee® wireless standard)
continuously dimmable
freely-adjustable light colour from DaylightWhite (6500 kelvin) to WarmWhite (2700 kelvin)
Memory feature - The lighting readjusts to the intensity and colour temperature that were set before the power was switched off.
Integral washbasin lighting (for surface-mounted mirror cabinets)
Loose mains connection (4-wires)

	SURFACE-MOUNTED MIRROR CABINET	SURFACE-MOUNTED MIRROR CABINET	SURFACE-MOUNTED MIRROR CABINET	SURFACE-MOUNTED MIRROR CABINET
Article number	A455 16 00	A457 16 00	A455 14 00	A457 14 00
Dimensions (w x h x d)	1600 x 750 x 168 mm	1600 x 750 x 168 mm	1400 x 750 x 168 mm	1400 x 750 x 168 mm
Version	with sensor switch	with on/off switch, Smart home compatible	with sensor switch	with on/off switch, Smart home compatible
Lighting	LED lighting Lighting 1 x LED main lighting / 44,64 W, 1 x LED washbasin lighting / 9,0 W	LED lighting Lighting 1 x LED main lighting / 44,64 W, 1 x LED washbasin lighting / 9,0 W	LED lighting Lighting 1 x LED main lighting / 40,80 W, 1 x LED washbasin lighting / 7,56 W	LED lighting Lighting 1 x LED main lighting / 40,80 W, 1 x LED washbasin lighting / 7,56 W
Equipped with	3x door 1 x sensor dimmer on the outside 2 x socket on the inside (right) 1 x socket on the outside (left) 4 x aluminium shelves 1x shelf 1x magnifying mirror 1x magnetic strip	3x door 1 x On/Off switch on the outside 2 x socket on the inside (right) 1 x socket on the outside (left) 4 x aluminium shelves 1x shelf 1x magnifying mirror 1x magnetic strip	3x door 1 x sensor dimmer on the outside 2 x socket on the inside (right) 1 x socket on the outside (left) 4 x aluminium shelves 1x shelf 1x magnifying mirror 1x magnetic strip	3x door 1 x On/Off switch on the outside 2 x socket on the inside (right) 1 x socket on the outside (left) 4 x aluminium shelves 1x shelf 1x magnifying mirror 1x magnetic strip
Note on standard	IP 44	IP 44	IP 44	IP 44
Please note	Mounted on the wall	Mounted on the wall	Mounted on the wall	Mounted on the wall
Scope of delivery	fastening set included	fastening set included	fastening set included	fastening set included









MY VIEW NOW

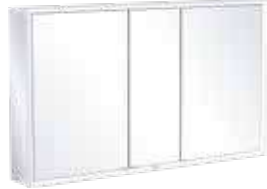
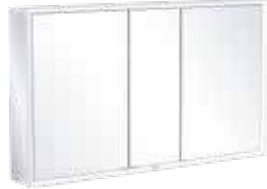









MY VIEW NOW

NEW

€ excl. VAT

Express Delivery These products are always in stock.

	SURFACE-MOUNTED MIRROR CABINET	SURFACE-MOUNTED MIRROR CABINET	SURFACE-MOUNTED MIRROR CABINET	SURFACE-MOUNTED MIRROR CABINET
				
		 		 
Article number	A455 13 00	A457 13 00	A455 12 00	A457 12 00
Dimensions (w x h x d)	1300 x 750 x 168 mm	1300 x 750 x 168 mm	1200 x 750 x 168 mm	1200 x 750 x 168 mm
Version	with sensor switch	with on/off switch, Smart home compatible	with sensor switch	with on/off switch, Smart home compatible
Lighting	LED lighting Lighting 1 x LED main lighting / 38,88 W, 1 x LED washbasin lighting / 6,84 W	LED lighting Lighting 1 x LED main lighting / 38,88 W, 1 x LED washbasin lighting / 6,84 W	LED lighting Lighting 1 x LED main lighting / 36,96 W, 1 x LED washbasin lighting / 6,12 W	LED lighting Lighting 1 x LED main lighting / 36,96 W, 1 x LED washbasin lighting / 6,12 W
Equipped with	3x door 1 x sensor dimmer on the outside 2 x socket on the inside (right) 1 x socket on the outside (left) 4 x aluminium shelves 1x shelf 1x magnifying mirror 1x magnetic strip	3x door 1 x On/Off switch on the outside 2 x socket on the inside (right) 1 x socket on the outside (left) 4 x aluminium shelves 1x shelf 1x magnifying mirror 1x magnetic strip	3x door 1 x sensor dimmer on the outside 2 x socket on the inside (right) 1 x socket on the outside (left) 4 x aluminium shelves 1x shelf 1x magnifying mirror 1x magnetic strip	3x door 1 x On/Off switch on the outside 2 x socket on the inside (right) 1 x socket on the outside (left) 4 x aluminium shelves 1x shelf 1x magnifying mirror 1x magnetic strip
Note on standard	IP 44	IP 44	IP 44	IP 44
Please note	Mounted on the wall	Mounted on the wall	Mounted on the wall	Mounted on the wall
Scope of delivery	fastening set included	fastening set included	fastening set included	fastening set included

	SURFACE-MOUNTED MIRROR CABINET	SURFACE-MOUNTED MIRROR CABINET	SURFACE-MOUNTED MIRROR CABINET	SURFACE-MOUNTED MIRROR CABINET
				
		 		 
Article number	A455 10 00	A457 10 00	A455 80 00	A457 80 00
Dimensions (w x h x d)	1000 x 750 x 168 mm	1000 x 750 x 168 mm	800 x 750 x 168 mm	800 x 750 x 168 mm
Version	with sensor switch	with on/off switch, Smart home compatible	with sensor switch	with on/off switch, Smart home compatible
Lighting	LED lighting Lighting 1 x LED main lighting / 33,12 W, 1 x LED washbasin lighting / 4,68 W	LED lighting Lighting 1 x LED main lighting / 33,12 W, 1 x LED washbasin lighting / 4,68 W	LED lighting Lighting 1 x LED main lighting / 29,28 W, 1 x LED washbasin lighting / 3,24 W	LED lighting Lighting 1 x LED main lighting / 29,28 W, 1 x LED washbasin lighting / 3,24 W
Equipped with	2x door 1 x sensor dimmer on the outside 2 x socket on the inside (left) 1 x socket on the outside (right) 2 x aluminium shelves 1x shelf 1x magnifying mirror 1x magnetic strip	2x door 1 x On/Off switch on the outside 2 x socket on the inside (left) 1 x socket on the outside (right) 2 x aluminium shelves 1x shelf 1x magnifying mirror 1x magnetic strip	2x door 1 x sensor dimmer on the outside 2 x socket on the inside (left) 1 x socket on the outside (right) 2 x aluminium shelves 1x shelf 1x magnifying mirror 1x magnetic strip	2x door 1 x On/Off switch on the outside 2 x socket on the inside (left) 1 x socket on the outside (right) 2 x aluminium shelves 1x shelf 1x magnifying mirror 1x magnetic strip
Note on standard	IP 44	IP 44	IP 44	IP 44
Please note	Mounted on the wall	Mounted on the wall	Mounted on the wall	Mounted on the wall
Scope of delivery	fastening set included	fastening set included	fastening set included	fastening set included

MY VIEW NOW

MY VIEW NOW

NEW

€ excl. VAT

Express Delivery These products are always in stock.

	SURFACE-MOUNTED MIRROR CABINET	SURFACE-MOUNTED MIRROR CABINET	SURFACE-MOUNTED MIRROR CABINET	SURFACE-MOUNTED MIRROR CABINET
Article number	A455 6L 00	A457 6L 00	A455 6R 00	A457 6R 00
Dimensions (w x h x d)	600 x 750 x 168 mm	600 x 750 x 168 mm	600 x 750 x 168 mm	600 x 750 x 168 mm
Version	with sensor switch	with on/off switch, Smart home compatible	with sensor switch	with on/off switch, Smart home compatible
Hinges	hinges on left	hinges on left	hinges on right	hinges on right
Lighting	LED lighting Lighting 1 x LED main lighting / 25,44 W, 1 x LED washbasin lighting / 1,8 W	LED lighting Lighting 1 x LED main lighting / 25,44 W, 1 x LED washbasin lighting / 1,8 W	LED lighting Lighting 1 x LED main lighting / 25,44 W, 1 x LED washbasin lighting / 1,8 W	LED lighting Lighting 1 x LED main lighting / 25,44 W, 1 x LED washbasin lighting / 1,8 W
Equipped with	1x door 1 x sensor dimmer on the outside 2 x socket on the inside (right) 1 x socket on the outside (left) 2 x aluminium shelves 1x shelf 1x magnifying mirror 1x magnetic strip	1x door 1 x On/Off switch on the outside 2 x socket on the inside (right) 1 x socket on the outside (left) 2 x aluminium shelves 1x shelf 1x magnifying mirror 1x magnetic strip	1x door 1 x sensor dimmer on the outside 2 x socket on the inside (left) 1 x socket on the outside (right) 2 x aluminium shelves 1x shelf 1x magnifying mirror 1x magnetic strip	1x door 1 x On/Off switch on the outside 2 x socket on the inside (left) 1 x socket on the outside (right) 2 x aluminium shelves 1x shelf 1x magnifying mirror 1x magnetic strip
Note on standard	IP 44	IP 44	IP 44	IP 44
Please note	Mounted on the wall	Mounted on the wall	Mounted on the wall	Mounted on the wall
Scope of delivery	fastening set included	fastening set included	fastening set included	fastening set included

	BUILT-IN MIRROR CABINET	BUILT-IN MIRROR CABINET	BUILT-IN MIRROR CABINET	BUILT-IN MIRROR CABINET
Article number	A456 16 00	A458 16 00	A456 14 00	A458 14 00
Dimensions (w x h x d)	1600 x 750 x 168 mm	1600 x 750 x 168 mm	1400 x 750 x 168 mm	1400 x 750 x 168 mm
Version	with sensor switch	with on/off switch, Smart home compatible	with sensor switch	with on/off switch, Smart home compatible
Lighting	LED lighting Lighting 1 x LED main lighting / 44,64 W	LED lighting Lighting 1 x LED main lighting / 44,64 W	LED lighting Lighting 1 x LED main lighting / 40,80 W	LED lighting Lighting 1 x LED main lighting / 40,80 W
Equipped with	3x door 1 x sensor dimmer on the outside 2 x socket on the inside (right) 4 x aluminium shelves 1x shelf 1x magnifying mirror 1x magnetic strip	3x door 1 x On/Off switch on the outside 2 x socket on the inside (right) 4 x aluminium shelves 1x shelf 1x magnifying mirror 1x magnetic strip	3x door 1 x sensor dimmer on the outside 2 x socket on the inside (right) 4 x aluminium shelves 1x shelf 1x magnifying mirror 1x magnetic strip	3x door 1 x On/Off switch on the outside 2 x socket on the inside (right) 4 x aluminium shelves 1x shelf 1x magnifying mirror 1x magnetic strip
Note on standard	IP 44	IP 44	IP 44	IP 44
Please note	Built-into the wall	Built-into the wall	Built-into the wall	Built-into the wall
Scope of delivery	fastening set included	fastening set included	fastening set included	fastening set included

MY VIEW NOW

NEW

€ excl. VAT

Express Delivery These products are always in stock.

	BUILT-IN MIRROR CABINET	BUILT-IN MIRROR CABINET	BUILT-IN MIRROR CABINET	BUILT-IN MIRROR CABINET
Article number	A456 13 00	A458 13 00	A456 12 00	A458 12 00
Dimensions (w x h x d)	1300 x 750 x 168 mm	1300 x 750 x 168 mm	1200 x 750 x 168 mm	1200 x 750 x 168 mm
Version	with sensor switch	with on/off switch, Smart home compatible	with sensor switch	with on/off switch, Smart home compatible
Lighting	LED lighting Lighting 1 x LED main lighting / 38,88 W	LED lighting Lighting 1 x LED main lighting / 38,88 W	LED lighting Lighting 1 x LED main lighting / 36,96 W	LED lighting Lighting 1 x LED main lighting / 36,96 W
Equipped with	3x door 1 x sensor dimmer on the outside 2 x socket on the inside (right) 4 x aluminium shelves 1x shelf 1x magnifying mirror 1x magnetic strip	3x door 1 x On/Off switch on the outside 2 x socket on the inside (right) 4 x aluminium shelves 1x shelf 1x magnifying mirror 1x magnetic strip	3x door 1 x sensor dimmer on the outside 2 x socket on the inside (right) 4 x aluminium shelves 1x shelf 1x magnifying mirror 1x magnetic strip	3x door 1 x On/Off switch on the outside 2 x socket on the inside (right) 4 x aluminium shelves 1x shelf 1x magnifying mirror 1x magnetic strip
Note on standard	IP 44	IP 44	IP 44	IP 44
Please note	Built-into the wall	Built-into the wall	Built-into the wall	Built-into the wall
Scope of delivery	fastening set included	fastening set included	fastening set included	fastening set included

	BUILT-IN MIRROR CABINET	BUILT-IN MIRROR CABINET	BUILT-IN MIRROR CABINET	BUILT-IN MIRROR CABINET
Article number	A456 10 00	A458 10 00	A456 80 00	A458 80 00
Dimensions (w x h x d)	1000 x 750 x 168 mm	1000 x 750 x 168 mm	800 x 750 x 168 mm	800 x 750 x 168 mm
Version	with sensor switch	with on/off switch, Smart home compatible	with sensor switch	with on/off switch, Smart home compatible
Lighting	LED lighting Lighting 1 x LED main lighting / 33,12 W	LED lighting Lighting 1 x LED main lighting / 33,12 W	LED lighting Lighting 1 x LED main lighting / 29,28 W	LED lighting Lighting 1 x LED main lighting / 29,28 W
Equipped with	2x door 1 x sensor dimmer on the outside 2 x socket on the inside (left) 2 x aluminium shelves 1x shelf 1x magnifying mirror 1x magnetic strip	2x door 1 x On/Off switch on the outside 2 x socket on the inside (left) 2 x aluminium shelves 1x shelf 1x magnifying mirror 1x magnetic strip	2x door 1 x sensor dimmer on the outside 2 x socket on the inside (left) 2 x aluminium shelves 1x shelf 1x magnifying mirror 1x magnetic strip	2x door 1 x On/Off switch on the outside 2 x socket on the inside (left) 2 x aluminium shelves 1x shelf 1x magnifying mirror 1x magnetic strip
Note on standard	IP 44	IP 44	IP 44	IP 44
Please note	Built-into the wall	Built-into the wall	Built-into the wall	Built-into the wall
Scope of delivery	fastening set included	fastening set included	fastening set included	fastening set included











MY VIEW NOW

MY VIEW NOW

NEW

€ excl. VAT

Express Delivery These products are always in stock.

	BUILT-IN MIRROR CABINET	BUILT-IN MIRROR CABINET	BUILT-IN MIRROR CABINET	BUILT-IN MIRROR CABINET
				
		 		 
Article number	A456 6L 00	A458 6L 00	A456 6R 00	A458 6R 00
Dimensions (w x h x d)	600 x 750 x 168 mm	600 x 750 x 168 mm	600 x 750 x 168 mm	600 x 750 x 168 mm
Version	with sensor switch	with on/off switch, Smart home compatible	with sensor switch	with on/off switch, Smart home compatible
Hinges	hinges on left	hinges on left	hinges on right	hinges on right
Lighting	LED lighting Lighting 1 x LED main lighting / 25,44 W	LED lighting Lighting 1 x LED main lighting / 25,44 W	LED lighting Lighting 1 x LED main lighting / 25,44 W	LED lighting Lighting 1 x LED main lighting / 25,44 W
Equipped with	1x door 1 x sensor dimmer on the outside 2 x socket on the inside (right) 2 x aluminium shelves 1x shelf 1x magnifying mirror 1x magnetic strip	1x door 1 x On/Off switch on the outside 2 x socket on the inside (right) 2 x aluminium shelves 1x shelf 1x magnifying mirror 1x magnetic strip	1x door 1 x sensor dimmer on the outside 2 x socket on the inside (left) 2 x aluminium shelves 1x shelf 1x magnifying mirror 1x magnetic strip	1x door 1 x On/Off switch on the outside 2 x socket on the inside (left) 2 x aluminium shelves 1x shelf 1x magnifying mirror 1x magnetic strip
Note on standard	IP 44	IP 44	IP 44	IP 44
Please note	Built-into the wall	Built-into the wall	Built-into the wall	Built-into the wall
Scope of delivery	fastening set included	fastening set included	fastening set included	fastening set included

MY VIEW NOW

MY VIEW ONE

Bathroom furniture

- Profi segment
- Match all collections/furniture programmes

PRO.VILLEROY-BOCH.COM/TECHNICALDRAWINGS



MY VIEW ONE

MY VIEW ONE

€ excl. VAT









Goods in stock

Express Delivery These products are always in stock.

Body:
Aluminium, mirrored at the side (3 mm mirror)
interior colour Aluminium, anodised silver

surface-mounted LED light
5700 K
loose mains connection

Lighting:

	SURFACE-MOUNTED MIRROR CABINET	SURFACE-MOUNTED MIRROR CABINET	SURFACE-MOUNTED MIRROR CABINET	SURFACE-MOUNTED MIRROR CABINET
				
				
Article number	A441 13 00	A440 12 00	A440 10 00	A439 80 00
Dimensions (w x h x d)	1307 x 810 x 224 mm	1207 x 810 x 224 mm	1007 x 810 x 224 mm	807 x 810 x 224 mm
Lighting	LED lighting	LED lighting	LED lighting	LED lighting
Equipped with	2x surface-mounted light 3x door 4x glass shelf 1x magnifying mirror 1x magnetic strip switch and socket	2x surface-mounted light 3x door 4x glass shelf 1x magnifying mirror 1x magnetic strip switch and socket	1x surface-mounted light 2x door 4x glass shelf 1x magnifying mirror 1x magnetic strip switch and socket	1x surface-mounted light 2x door 2x glass shelf 1x magnifying mirror 1x magnetic strip switch and socket
Note on standard	IP 44	IP 44	IP 44	IP 44
Please note	Mounted on the wall	Mounted on the wall	Mounted on the wall	Mounted on the wall
Scope of delivery	fastening set included	fastening set included	fastening set included	fastening set included

SURFACE-MOUNTED MIRROR CABINET





Article number	A439 60 00
Dimensions (w x h x d)	607 x 810 x 224 mm
Lighting	LED lighting
Equipped with	1x surface-mounted light 2x door 2x glass shelf 1x magnifying mirror 1x magnetic strip switch and socket
Note on standard	IP 44
Please note	Mounted on the wall
Scope of delivery	fastening set included

STAND-ALONE WASHBASINS

Bath ceramic

- Premium segment
- Selected washbasins also match the furniture programme Legato
- Designed to match all mirror collections
- Designed to match all mirror cabinet collections

PRO.VILLEROY-BOCH.COM/TECHNICALDRAWINGS



STAND-ALONE
WASHBASINS

Ceramic colours



01 = White Alpin



R1 = White Alpin
CeramicPlus

STAND-ALONE WASHBASINS

€ excl. VAT

Please order tap fittings and soap dispenser separately

MEMENTO WASHBASINS

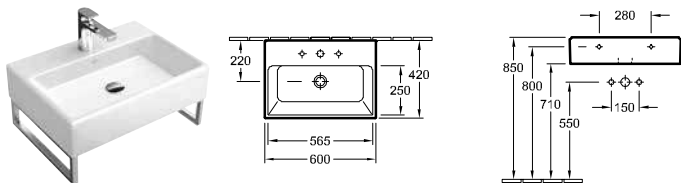

Article number	Description	01	plus R1		pcs/ pal.	kg/ pc.
5133 60 XX	600 x 420 mm				15	18

wall fixation, towel holder (not included in scope of delivery): side installation (mountable: 2 pc.)
For further information about matching valves, see pages 380-383

8749 37 D7	TOWEL RAIL (optional) 370 x 140 mm, stainless steel, side installation, fastening set included	-	-			1,038
9221 49 00	WASHBASIN INSTALLATION ELEMENT 525 x 1120 x 75 mm For further ViConnect models, see pages 368-379		-	-	10	8,05

MEMENTO WASHBASINS

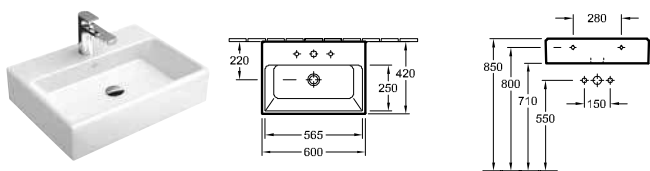

Article number	Description	01	plus R1		pcs/ pal.	kg/ pc.
5133 6L XX	600 x 420 mm				15	18

ground underside, wall fixation, incl. template, matching furniture programme: Legato
For further information about matching valves, see pages 380-383

9221 49 00	WASHBASIN INSTALLATION ELEMENT 525 x 1120 x 75 mm For further ViConnect models, see pages 368-379		-	-	10	8,05
------------	---	--	---	---	----	------

MEMENTO WASHBASINS

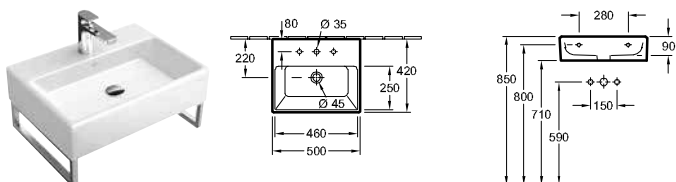

Article number	Description	01	plus R1		pcs/ pal.	kg/ pc.
5133 50 XX	500 x 420 mm				16	16

wall fixation, towel holder (not included in scope of delivery): side installation (mountable: 2 pc.)
For further information about matching valves, see pages 380-383

8749 37 D7	TOWEL RAIL (optional) 370 x 140 mm, stainless steel, side installation, fastening set included	-	-			1,038
9221 49 00	WASHBASIN INSTALLATION ELEMENT 525 x 1120 x 75 mm For further ViConnect models, see pages 368-379		-	-	10	8,05

XX = Colour code to be indicated
01 = White Alpin, R1 = White Alpin CeramicPlus

STAND-ALONE WASHBASINS

€ excl. VAT

Please order tap fittings and soap dispenser separately

MEMENTO WASHBASINS

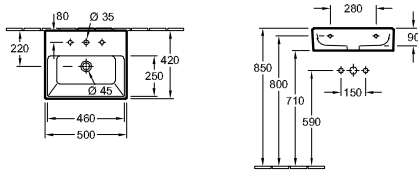

Article number	Description	01	plus R1		pcs/ pal.	kg/ pc.
5133 5L XX	500 x 420 mm			-	16	16
ground underside, wall fixation, incl. template, matching furniture programme: Legato For further information about matching valves, see pages 380-383						
9221 49 00	WASHBASIN INSTALLATION ELEMENT 525 x 1120 x 75 mm	-	-		10	8,05
For further ViConnect models, see pages 368-379						

MEMENTO SEMI-RECESSED WASHBASIN

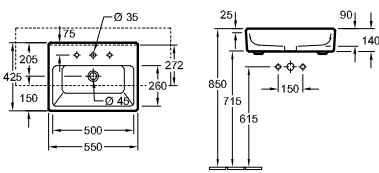

Article number	Description	01	plus R1		pcs/ pal.	kg/ pc.
4133 55 XX	550 x 425 mm			-	12	15,6
incl. template, fastening set included For further information about matching valves, see pages 380-383						

LUNEA UNDERCOUNTER WASHBASIN

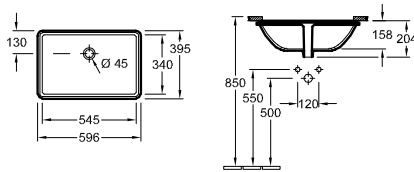

Article number	Description	01			pcs/ pal.	kg/ pc.
5122 53 XX	535 x 335 mm without tap hole area			-	24	10,18
the hole for the washbasin can only be cut out using the original washbasin because tolerances of several millimetres are possible, fastening set included For further information about matching valves, see pages 380-383						

TUBE UNDERCOUNTER WASHBASIN

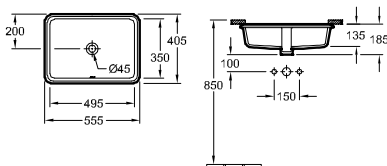

Article number	Description	01			pcs/ pal.	kg/ pc.
4152 50 01	495 x 350 mm without tap hole area			-	10	12,26
For further information about matching valves, see pages 380-383						

XX = Colour code to be indicated
01 = White Alpin, R1 = White Alpin CeramicPlus

STAND-ALONE
WASHBASINS

STAND-ALONE WASHBASINS



€ excl. VAT

Please order tap fittings and soap dispenser separately

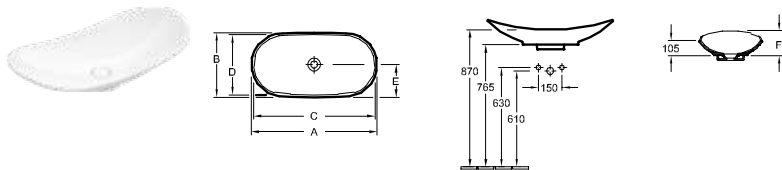
MY NATURE SURFACE-MOUNTED WASHBASIN



Article no.	A	B	C	D	E	F
411080XX	810	410	785	380	205	160
411060XX	610	360	575	330	180	150

Article number	Description	plus R1	pcs/ pal.	kg/ pc.
4110 80 XX	810 x 410 mm without tap hole area 		-	15 11,4
4110 60 XX	610 x 360 mm without tap hole area 		-	10 8,7

incl. unclosable valve with ceramic valve cover, fastening set included, matching furniture programme: Legato
Please note: unclosable outlet valve must be used with models without overflow

STAND-ALONE WASHBASINS

XX = Colour code to be indicated
01 = White Alpin, R1 = White Alpin CeramicPlus

SUBWAY 3.0

NEW

PRO.VILLEROY-BOCH.COM/TECHNICALDRAWINGS



Sanitaryware and Bathroom Furniture

- Mainstream segment
- Matching furniture programme Subway 3.0
- Designed to match all mirror collections
- Designed to match all mirror cabinet collections
- matching wellness programme Subway 3.0



SUBWAY 3.0

Ceramic colours

- | | | | | |
|------------------|------------------------------|------------------------------|--------------------------|--------------------------------------|
| | | | | |
| O1 = White Alpin | R1 = White Alpin CeramicPlus | RW = Stone White CeramicPlus | T1 = White Alpin AntiBac | T2 = White Alpin AntiBac CeramicPlus |

Front- / Body colours

- | | | | | | | | | | |
|----------------------|-----------------|--------------------|------------|--------------------|------------------|---------------|-----------------|----------------|------------------|
| | | | | | | | | | |
| VE = Brilliant White | VF = Pure White | VL = Volcano Black | VM = Taupe | VN = Cashmere Grey | VQ = Marine Blue | VR = Graphite | RH = Oak Kansas | RK = Stone Oak | VH = Arizona Oak |
- VJ = Nordic Oak

SUBWAY 3.0

NEW

Bathroom furniture

The article numbers for the Subway 3.0 bathroom furniture are made up as follows:

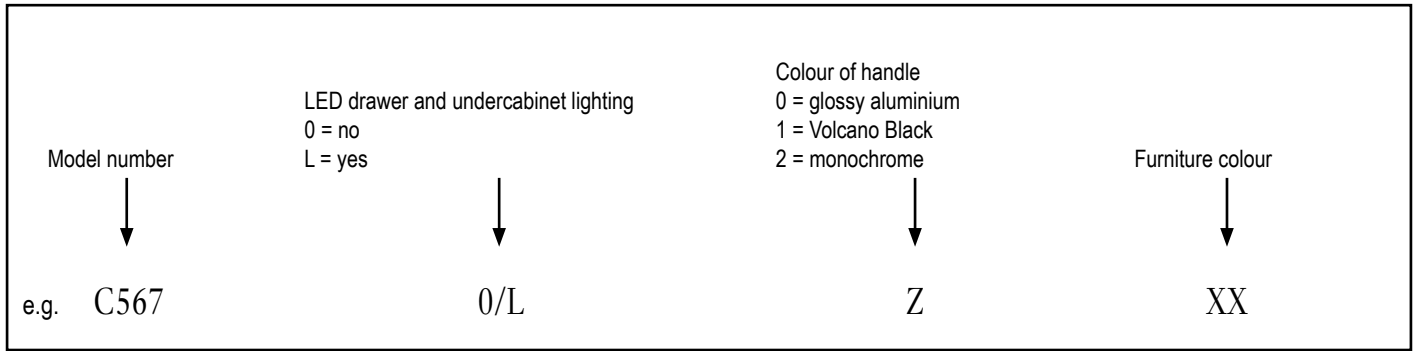

Individual colour accents

Numerous combinations of handle and furniture colours are possible for setting individual highlights. The characteristic handle runs like a continuous line across the entire width of the furniture and is available in the following colours:

- Glossy aluminium: coordinates well with all the furniture colours
- Volcano Black: for combination with all furniture colours
- Monochrome (handle and furniture are identical in colour): available for the furniture colours Taupe, Cashmere Grey, Marine Blue and Graphite

Glossy aluminium handle

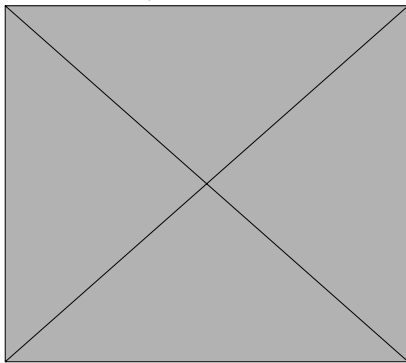

Handle Volcano Black

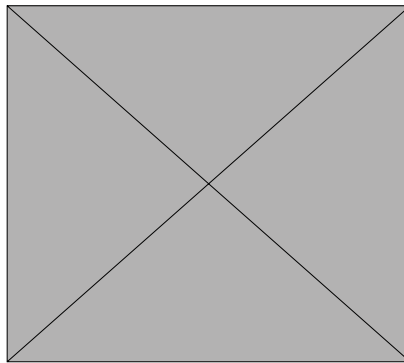

Handle monochrome

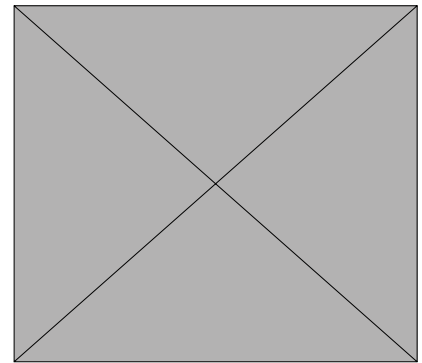

SUBWAY 3.0

Lighting concept



The vanity units in the Subway 3.0 collection are optionally fitted with innovative LED under-cabinet lighting, complete with the Emotion feature that provides orientation or mood lighting in the washing area. The lighting is controlled using a touch sensor on the side of the vanity unit. Smart controls are also available for retrofitting with the separately available kit (C585 00 00).

Thanks to the Zigbee Home Automation standard, this piece of furniture can be connected to all the hubs/gateways that use this transmission standard, e.g. Philips Hue Bridge, Amazon Echo Show or Echo Plus (2nd generation).

The upper pull-out elements on these vanity units also come fitted with built-in LED lighting that uses an integrated motion sensor to switch on or off automatically when these drawers are opened/closed.

The LED lighting that surrounds the mirrors can be controlled using the touch sensor on the mirror's surface. Here, too, smart lighting control can also be retrofitted with a separately available kit (C004 00 00).



SUBWAY 3.0

NEW

€ excl. VAT

Please order tap fittings and soap dispenser separately

DOUBLE VANITY WASHBASIN

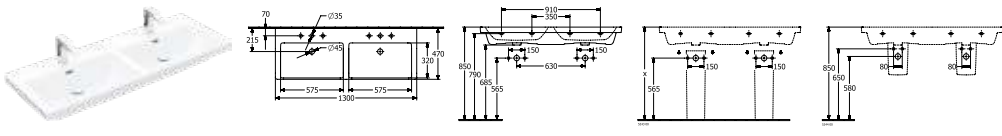

Article number	Description	01	plus R1	plus RW		pcs/ pal.	kg/ pc.
4A71 D5 XX	1300 x 470 mm 2x				-		38,1
4A71 D1 XX	1300 x 470 mm 2x				-		38,1
4A71 D3 XX	1300 x 470 mm				-		38,1

wall fixation, matching furniture programme: Subway 3.0
 For further information about matching valves and CAP, see pages 380-383
 Please note: unclosable outlet valve must be used with models without overflow

5244 00 XX	TRAP COVER cannot be combined with 3-hole tap fittings, incl. fastening set "SmartFix"				-	40	5,59
9221 49 00	WASHBASIN INSTALLATION ELEMENT 525 x 1120 x 75 mm For further ViConnect models, see pages 368-379				-	10	8,05

VANITY WASHBASIN

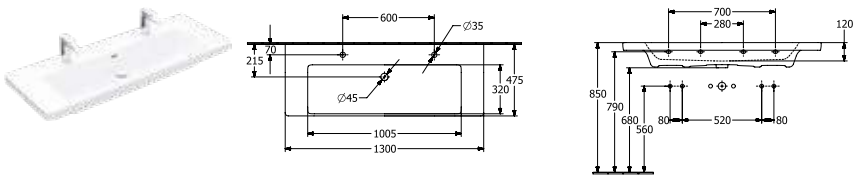

Article number	Description	01	plus R1	plus RW		pcs/ pal.	kg/ pc.
4A70 D4 XX	1300 x 470 mm 2x with 2 single-lever mixers and turn-knob operation or in conjunction with toggle valve, as well as push-open valve, please do not exceed a flow rate of max. 7.5 l/min per tap fitting.				-		36
4A70 D1 XX	1300 x 470 mm 2x				-		36

wall fixation, matching furniture programme: Subway 3.0
 For further information about matching valves and CAP, see pages 380-383
 Please note: unclosable outlet valve must be used with models without overflow

5244 00 XX	TRAP COVER cannot be combined with 3-hole tap fittings, incl. fastening set "SmartFix"				-	40	5,59
9221 49 00	WASHBASIN INSTALLATION ELEMENT 525 x 1120 x 75 mm For further ViConnect models, see pages 368-379				-	10	8,05

VANITY WASHBASIN

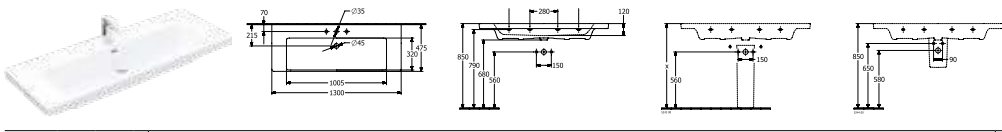

Article number	Description	01	plus R1	plus RW		pcs/ pal.	kg/ pc.
4A70 D5 XX	1300 x 470 mm				-		36
4A70 D2 XX	1300 x 470 mm				-		36
4A70 D3 XX	1300 x 470 mm				-		36

wall fixation, matching furniture programme: Subway 3.0
 For further information about matching valves and CAP, see pages 380-383
 Please note: unclosable outlet valve must be used with models without overflow

5244 00 XX	TRAP COVER cannot be combined with 3-hole tap fittings, incl. fastening set "SmartFix"				-	40	5,59
9221 49 00	WASHBASIN INSTALLATION ELEMENT 525 x 1120 x 75 mm For further ViConnect models, see pages 368-379				-	10	8,05

XX = Colour code to be indicated
 01 = White Alpin, R1 = White Alpin CeramicPlus, RW = Stone White CeramicPlus, T1 = White Alpin AntiBac, T2 = White Alpin AntiBac CeramicPlus

SUBWAY 3.0

SUBWAY 3.0



NEW

€ excl. VAT

Please order tap fittings and soap dispenser separately

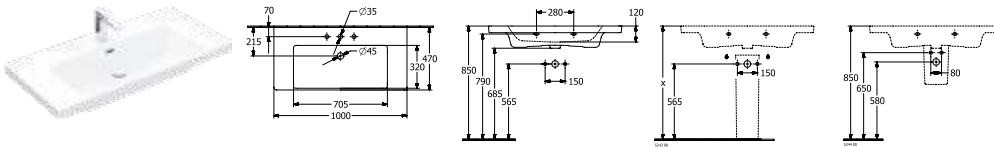
VANITY WASHBASIN





Article number	Description	01	plus R1	plus RW		pcs/ pal.	kg/ pc.
4A70 A5 XX	1000 x 470 mm 				-	8	28
4A70 A2 XX	1000 x 470 mm 				-	8	28
4A70 A3 XX	1000 x 470 mm 				-	8	28

wall fixation, matching furniture programme: Subway 3.0



For further information about matching valves and CAP, see pages 380-383

Please note: unclosable outlet valve must be used with models without overflow

5244 00 XX	TRAP COVER cannot be combined with 3-hole tap fittings, incl. fastening set "SmartFix"				-	40	5,59
9221 49 00	WASHBASIN INSTALLATION ELEMENT 525 x 1120 x 75 mm For further ViConnect models, see pages 368-379		-	-	-	10	8,05

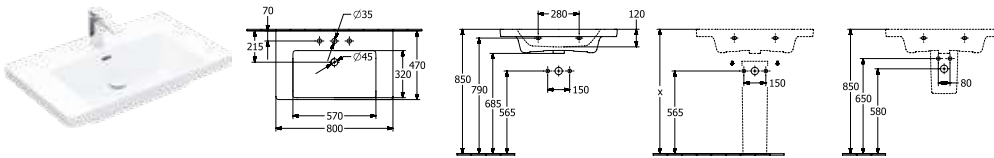
VANITY WASHBASIN





Article number	Description	01	plus R1	plus RW		pcs/ pal.	kg/ pc.
4A70 80 XX	800 x 470 mm 				-	12	23
4A70 81 XX	800 x 470 mm 				-	12	23
4A70 83 XX	800 x 470 mm 				-	12	23

wall fixation, matching furniture programme: Subway 3.0

For further information about matching valves and CAP, see pages 380-383

Please note: unclosable outlet valve must be used with models without overflow

5244 00 XX	TRAP COVER cannot be combined with 3-hole tap fittings, incl. fastening set "SmartFix"				-	40	5,59
9221 49 00	WASHBASIN INSTALLATION ELEMENT 525 x 1120 x 75 mm For further ViConnect models, see pages 368-379		-	-	-	10	8,05

XX = Colour code to be indicated

01 = White Alpin, R1 = White Alpin CeramicPlus, RW = Stone White CeramicPlus, T1 = White Alpin AntiBac, T2 = White Alpin AntiBac CeramicPlus

SUBWAY 3.0

NEW

€ excl. VAT

Please order tap fittings and soap dispenser separately

VANITY WASHBASIN

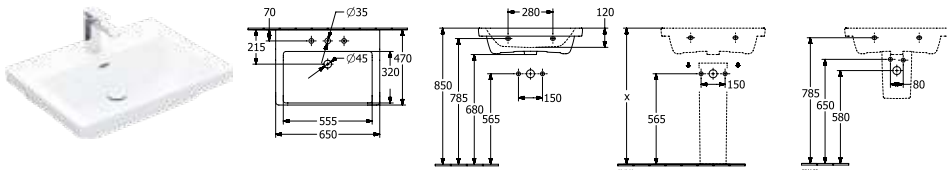

Article number	Description	01	plus R1	plus RW		pcs/ pal.	kg/ pc.
4A70 65 XX	650 x 470 mm				-	16	19,2
4A70 66 XX	650 x 470 mm				-	16	19,2
4A70 68 XX	650 x 470 mm				-	16	19,2

wall fixation, matching furniture programme: Subway 3.0

For further information about matching valves and CAP, see pages 380-383

Please note: unclosable outlet valve must be used with models without overflow

5244 00 XX	TRAP COVER cannot be combined with 3-hole tap fittings, incl. fastening set "SmartFix"				-	40	5,59
9221 49 00	WASHBASIN INSTALLATION ELEMENT 525 x 1120 x 75 mm For further ViConnect models, see pages 368-379		-	-	-	10	8,05

VANITY WASHBASIN

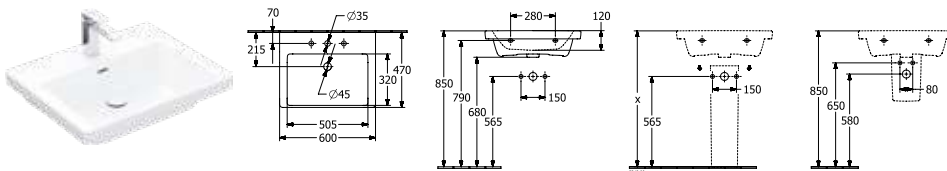

Article number	Description	01	plus R1	plus RW		pcs/ pal.	kg/ pc.
4A70 60 XX	600 x 470 mm				-	18	18
4A70 61 XX	600 x 470 mm				-	18	18
4A70 63 XX	600 x 470 mm				-	18	18

wall fixation, matching furniture programme: Subway 3.0

For further information about matching valves and CAP, see pages 380-383

Please note: unclosable outlet valve must be used with models without overflow

5244 00 XX	TRAP COVER cannot be combined with 3-hole tap fittings, incl. fastening set "SmartFix"				-	40	5,59
9221 49 00	WASHBASIN INSTALLATION ELEMENT 525 x 1120 x 75 mm For further ViConnect models, see pages 368-379		-	-	-	10	8,05

SUBWAY 3.0

XX = Colour code to be indicated
 01 = White Alpin, R1 = White Alpin CeramicPlus, RW = Stone White CeramicPlus, T1 = White Alpin AntiBac, T2 = White Alpin AntiBac CeramicPlus

SUBWAY 3.0

NEW

€ excl. VAT

Please order tap fittings and soap dispenser separately

VANITY WASHBASIN

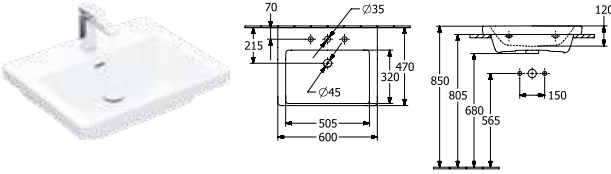

Article number	Description	01	plus R1	plus RW		pcs/ pal.	kg/ pc.
4A70 6G XX	600 x 470 mm				-	10	19,2
4A70 6L XX	600 x 470 mm				-	10	19,2
4A70 6F XX	600 x 470 mm				-	10	19,2

ground underside, wall fixation, matching furniture programme: Subway 3.0

For further information about matching valves and CAP, see pages 380-383

Please note: unclosable outlet valve must be used with models without overflow

9221 49 00	WASHBASIN INSTALLATION ELEMENT 525 x 1120 x 75 mm For further ViConnect models, see pages 368-379					10	8,05
------------	--	--	--	--	--	----	------

WASHBASINS

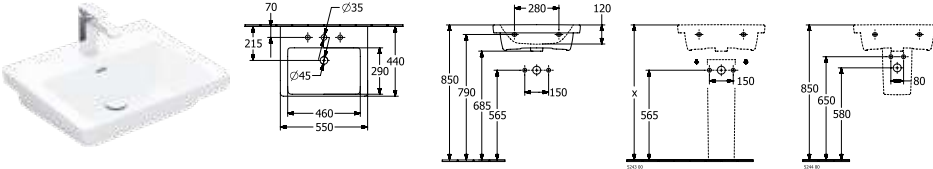

Article number	Description	01	plus R1	plus RW		pcs/ pal.	kg/ pc.
4A70 55 XX	550 x 440 mm				-		17,6
4A70 56 XX	550 x 440 mm				-		17,6
4A70 58 XX	550 x 440 mm				-		17,6

wall fixation

For further information about matching valves and CAP, see pages 380-383

Please note: unclosable outlet valve must be used with models without overflow

5244 00 XX	TRAP COVER cannot be combined with 3-hole tap fittings, incl. fastening set "SmartFix"					40	5,59
9221 49 00	WASHBASIN INSTALLATION ELEMENT 525 x 1120 x 75 mm For further ViConnect models, see pages 368-379					10	8,05

WASHBASINS

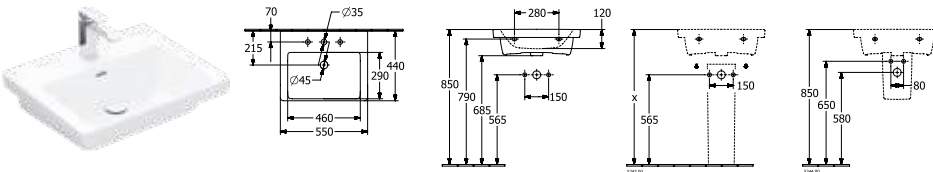

Article number	Description	01	plus R1	plus RW		pcs/ pal.	kg/ pc.
4A70 F4 XX	550 x 440 mm				-		17,6
4A70 F5 XX	550 x 440 mm				-		17,6
4A70 F6 XX	550 x 440 mm				-		17,6

wall fixation, for installation with furniture Subway 3.0, matching furniture programme: Subway 3.0

For further information about matching valves and CAP, see pages 380-383

Please note: unclosable outlet valve must be used with models without overflow

9221 49 00	WASHBASIN INSTALLATION ELEMENT 525 x 1120 x 75 mm For further ViConnect models, see pages 368-379					10	8,05
------------	--	--	--	--	--	----	------

XX = Colour code to be indicated

01 = White Alpin, R1 = White Alpin CeramicPlus, RW = Stone White CeramicPlus, T1 = White Alpin AntiBac, T2 = White Alpin AntiBac CeramicPlus

SUBWAY 3.0



NEW

€ excl. VAT

Please order tap fittings and soap dispenser separately

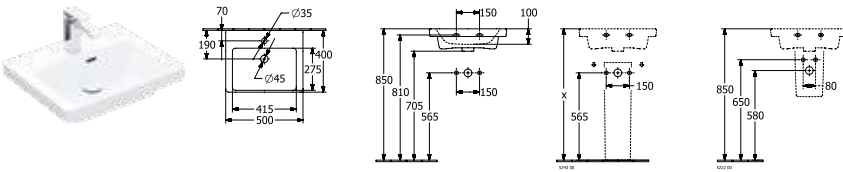
HANDWASHBASIN



Article number	Description	01	plus R1	plus RW		pcs/ pal.	kg/ pc.
4370 50 XX	500 x 400 mm 				-		11,5
4370 51 XX	500 x 400 mm 				-		11,5



For further information about matching valves and CAP, see pages 380-383

Please note: unclosable outlet valve must be used with models without overflow

5222 00 XX	TRAP COVER cannot be combined with 3-hole tap fittings, fastening set included				-	50	7,35
9221 49 00	WASHBASIN INSTALLATION ELEMENT 525 x 1120 x 75 mm For further ViConnect models, see pages 368-379		-	-	-	10	8,05

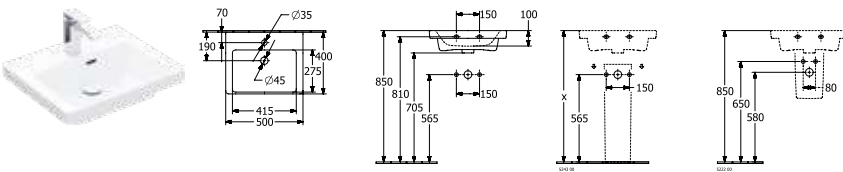
HANDWASHBASIN



Article number	Description	01	plus R1	plus RW		pcs/ pal.	kg/ pc.
4370 FF XX	500 x 400 mm 				-		11,5
4370 FG XX	500 x 400 mm 				-		11,5

for installation with furniture Subway 3.0, matching furniture programme: Subway 3.0



For further information about matching valves and CAP, see pages 380-383

Please note: unclosable outlet valve must be used with models without overflow

9221 49 00	WASHBASIN INSTALLATION ELEMENT 525 x 1120 x 75 mm For further ViConnect models, see pages 368-379		-	-	-	10	8,05
------------	--	---	---	---	---	----	------

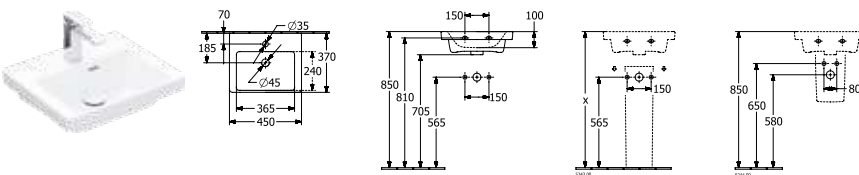
HANDWASHBASIN



Article number	Description	01	plus R1	plus RW		pcs/ pal.	kg/ pc.
4370 45 XX	450 x 370 mm 				-		10,5
4370 46 XX	450 x 370 mm 				-		10,5

For further information about matching valves and CAP, see pages 380-383

Please note: unclosable outlet valve must be used with models without overflow

5222 00 XX	TRAP COVER cannot be combined with 3-hole tap fittings, fastening set included				-	50	7,35
9221 49 00	WASHBASIN INSTALLATION ELEMENT 525 x 1120 x 75 mm For further ViConnect models, see pages 368-379		-	-	-	10	8,05

XX = Colour code to be indicated

01 = White Alpin, R1 = White Alpin CeramicPlus, RW = Stone White CeramicPlus, T1 = White Alpin AntiBac, T2 = White Alpin AntiBac CeramicPlus

SUBWAY 3.0



NEW

€ excl. VAT

Please order tap fittings and soap dispenser separately

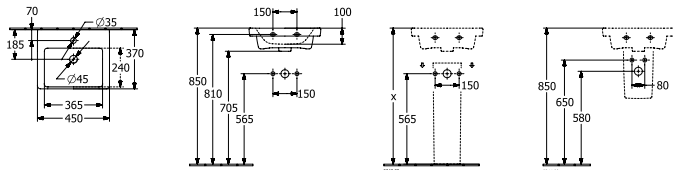
HANDWASHBASIN



Article number	Description	01	plus R1	plus RW		pcs/ pal.	kg/ pc.
4370 FK XX	450 x 370 mm 				-		10,5
4370 FL XX	450 x 370 mm 				-		10,5

for installation with furniture Subway 3.0, matching furniture programme: Subway 3.0



For further information about matching valves and CAP, see pages 380-383

Please note: unclosable outlet valve must be used with models without overflow

9221 49 00	WASHBASIN INSTALLATION ELEMENT 525 x 1120 x 75 mm For further ViConnect models, see pages 368-379		-	-	-	10	8,05
------------	--	---	---	---	---	----	------

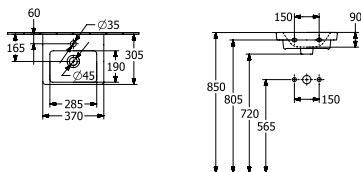
HANDWASHBASIN



Article number	Description	01	plus R1	plus RW		pcs/ pal.	kg/ pc.
4370 37 XX	370 x 305 mm 				-		6,8
4370 38 XX	370 x 305 mm 				-		6,8

matching furniture programme: Subway 3.0

For further information about matching valves and CAP, see pages 380-383

Please note: unclosable outlet valve must be used with models without overflow

9221 49 00	WASHBASIN INSTALLATION ELEMENT 525 x 1120 x 75 mm For further ViConnect models, see pages 368-379		-	-	-	10	8,05
------------	--	---	---	---	---	----	------

CORNER HANDWASHBASIN

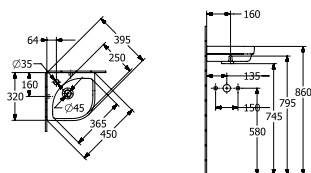

Article number	Description	01	plus R1	plus RW		pcs/ pal.	kg/ pc.
4371 46 XX	320 mm side length 				-		8,2

For further information about matching valves, see pages 380-383

Please note: unclosable outlet valve must be used with models without overflow

XX = Colour code to be indicated

01 = White Alpin, R1 = White Alpin CeramicPlus, RW = Stone White CeramicPlus, T1 = White Alpin AntiBac, T2 = White Alpin AntiBac CeramicPlus

SUBWAY 3.0

NEW

€ excl. VAT

Please order tap fittings and soap dispenser separately

BIDET

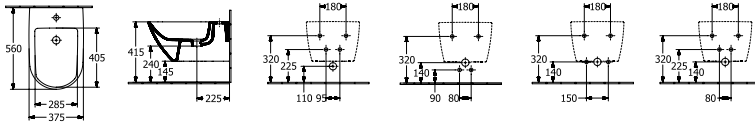

Article number	Description	01	plus R1	plus RW		pcs/ pal.	kg/ pc.
4470 00 XX	375 x 560 mm						19
wall-mounted, incl. closing valve with ceramic valve cover, with fastening set for concealed fastening							
9953 00 00	FASTENING FRAME (optional)	-	-	-			2,93
9221 48 00	BIDET INSTALLATION SYSTEM 525 x 1120 x 100 mm For further ViConnect models, see pages 368-379		-	-	-	10	10,54

WASHDOWN TOILET, RIMLESS

TwistFlush

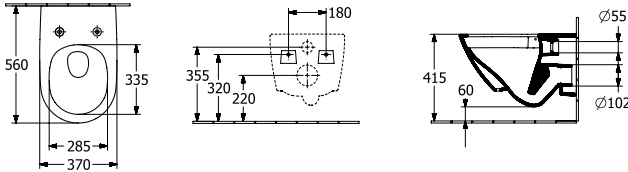

Article number	Description	01	plus R1	plus RW	T1	T2	pcs/ pal.	kg/ pc.
4670 T0 XX	370 x 560 mm 				-	-		23
wall-mounted, horizontal outlet, incl. fastening set "SupraFix 3.0", with water-saving AQUAREDUCT® system: flush volume 3 / 4,5 litres, not suitable for installation with flush valves								
8M42 S1 XX	TOILET SEAT AND COVER with QuickRelease and SoftClosing hinges, hinges in stainless steel		-	-	-	-		2,63
8M42 61 XX	TOILET SEAT AND COVER hinges in stainless steel		-	-	-	-		2,65
9M78 S1 XX	TOILET SEAT AND COVER SLIMSEAT with QuickRelease and SoftClosing hinges, hinges in stainless steel 		-	-	-	-	90	2,968
9222 87 00	VIPROTECT SOUNDPROOFING SET (optional) incl. accessories	-	-	-	-	-	600	0,086
9224 65 00	TOILET INSTALLATION SYSTEM for dry-wall construction, low 450 x 1120 x 165 mm For further ViConnect models, see pages 368-379 	-	-	-	-	-	8	19,78
9224 27 00	TOILET INSTALLATION SYSTEM for dry-wall construction, standard height 525 x 1120 x 135 mm For further ViConnect models, see pages 368-379 	-	-	-	-	-	10	15,8

COMBI-PACK

TwistFlush

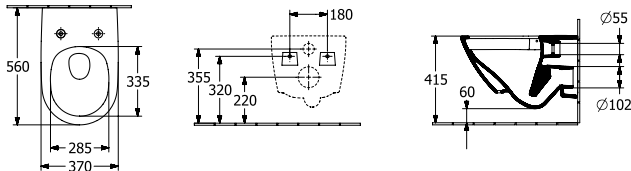

Article number	Description	01	plus R1	plus RW		pcs/ pal.	kg/ pc.	
4670 TS XX	individual packaging materials, wall-mounted, horizontal outlet composed of: Washdown WC TwistFlush 4670 T0 XX, WC-seat and cover with QuickRelease and SoftClosing hinges 8M42 S1 01 				-	-	12	25,6

XX = Colour code to be indicated
01 = White Alpin, R1 = White Alpin CeramicPlus, RW = Stone White CeramicPlus, T1 = White Alpin AntiBac, T2 = White Alpin AntiBac CeramicPlus

SUBWAY 3.0

SUBWAY 3.0

NEW

€ excl. VAT

Please order tap fittings and soap dispenser separately

WASHDOWN TOILET, RIMLESS

TwistFlush

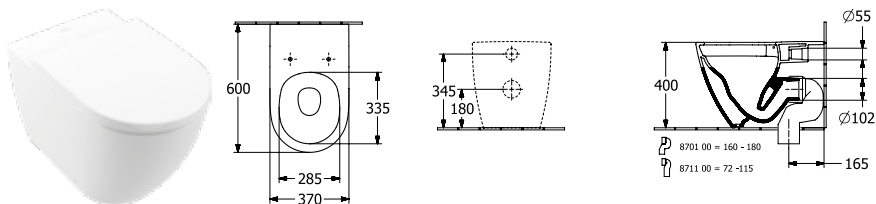

Article number	Description	01	plus R1	plus RW	T1	plus T2	pcs/ pal.	kg/ pc.
4671 T0 XX	370 x 600 mm				-	-		32

floor-standing, back to wall, horizontal outlet, with fastening set for concealed fastening, with water-saving AQUAREDUCT® system: flush volume 3 / 4,5 litres, not suitable for installation with flush valves

8M42 S1 XX	TOILET SEAT AND COVER with QuickRelease and SoftClosing hinges, hinges in stainless steel		-			-		2,63
8M42 61 XX	TOILET SEAT AND COVER hinges in stainless steel		-		-	-		2,65
9M78 S1 XX	TOILET SEAT AND COVER SLIMSEAT with QuickRelease and SoftClosing hinges, hinges in stainless steel		-	-		-	90	2,968
8711 00 00	VARIO DRAINBEND for vertical outlet 72 - 115 mm		-	-	-	-		0,72
9221 87 00	VARIO DRAINBEND for vertical outlet for installation close to the wall 115 - 160 mm		-	-	-	-		1,95
8701 00 00	VARIO DRAINBEND for vertical outlet for installation close to the wall 160 - 180 mm		-	-	-	-		0,74

TOILET SEAT AND COVER



Article number	Description	01	T1	plus RW	pcs/ pal.	kg/ pc.
8M42 S1 XX	with QuickRelease and SoftClosing hinges, hinges in stainless steel				-	2,63
8M42 61 XX	hinges in stainless steel		-	-	-	2,65

TOILET SEAT AND COVER SLIMSEAT



Article number	Description	01	T1	plus RW	pcs/ pal.	kg/ pc.
9M78 S1 XX	with QuickRelease and SoftClosing hinges, hinges in stainless steel				90	2,968

TOILET SEAT AND COVER



Article number	Description	01	T1	plus RW	pcs/ pal.	kg/ pc.
9M68 S1 XX	with QuickRelease and SoftClosing hinges, hinges in stainless steel		-	-	90	3,647

XX = Colour code to be indicated
 01 = White Alpin, R1 = White Alpin CeramicPlus, RW = Stone White CeramicPlus, T1 = White Alpin AntiBac, T2 = White Alpin AntiBac CeramicPlus

SUBWAY 3.0

NEW

€ excl. VAT

Please order tap fittings and soap dispenser separately

SEAT



Article number	Description	01	T1	plus RW		pcs/ pal.	kg/ pc.
9M74 61 01	hinges in stainless steel		-	-	-	90	1,35

SUBWAY 3.0

XX = Colour code to be indicated
 01 = White Alpin, R1 = White Alpin CeramicPlus, RW = Stone White CeramicPlus, T1 = White Alpin AntiBac, T2 = White Alpin AntiBac CeramicPlus

SUBWAY 3.0

NEW

€ excl. VAT

Produced to order (Please note that it is not always possible to cancel or change orders!), The washbasins are to be ordered separately.

Express Delivery

These products are always available from stock in the colours: **Kansas Oak (RH)** and **Brilliant White (VE)** in handle colour **0 (glossy aluminium)**

- Front:**
 Painted chipboard in VE, VF, VL, VM, VN, VQ, VR (16 mm)
 direct-laminated chipboard in VH, VJ, RH, RK (16 mm)
 Horizontal grain in VH, VJ, RH, RK
 Interior colour to match décor in VH, VJ, RH, RK
 Interior colour, direct-laminated, to match colour in VE, VF, VL, VM, VN, VQ, VR
 Interior colour open compartments in Anthracite
- Body:**
 Painted chipboard in VE, VF, VL, VM, VN, VQ, VR (8 mm)
 direct-laminated chipboard in VH, VJ, RH, RK (8 mm)
 Horizontal grain in VH, VJ, RH, RK
- Interior body:**
 direct-laminated chipboard in anthracite
- Washbasin countertop:**
 Painted chipboard in VE, VF, VL, VM, VN, VQ, VR (8 mm)
 direct-laminated chipboard in VH, VJ, RH, RK (8 mm)
- Drawers:**
 Slip-resistant base
 SoftClosing feature
- Doors:**
 SoftClosing feature
- Handles:**
 Handle strip aluminium glossy, aluminium lacquered
- Interior compartments :**
 Accessory dish, plastic in Anthracite (L: 300 mm, W: 100 mm, H: 50 mm)
- Mirrors:**
 Illuminated mirror (4 mm) with frame
Mirror frame:
 28 mm x 47.5 mm aluminium frame (square, painted)
 30 mm x 45 mm aluminium frame (round, painted)
 in the colours White Matt, Bicolour (inside White Matt, outside Black Matt)
Mirror shelf:
 Mirror (3 mm)
Lighting:
 Vanity unit: with LED under-cabinet lighting
 Illuminated mirror: with all-round LED lighting continuously dimmable
 freely-adjustable light colour from DaylightWhite (6500 kelvin) to WarmWhite (2700 kelvin)
 Light control via sensor switch by touching the logo on the mirror surface or smart light control (Zigbee radio standard) with ZIGBEE® HOME AUTOMATION KIT (C585 00 00 for vanity units, C004 00 00 for illuminated mirrors)
 Memory feature - The lighting readjusts to the intensity and colour temperature that were set before the power was switched off.
 Drawer lighting in neutral white (4000 K) - switches on and off automatically when the drawer is opened and closed
- Colour combinations of furniture finish and handle:**
 Handle in glossy aluminium for combination with all furniture colours
 Handle in Volcano Black for combination with all furniture colours
 with monochrome colours, always supplied in a / always opt for a monochrome look, with the exception of Brilliant White and White Matt (these can only be combined with Aluminium and Volcano Black)

Please note:
 For further information such as tap fitting positions, installation and fastening dimensions etc. please see the technical drawings.

	VANITY UNIT	VANITY UNIT	VANITY UNIT	VANITY UNIT
Article number	C567 OZ XX	C567 LZ XX	C568 OZ XX	C568 LZ XX
Dimensions (w x h x d)	1272 x 429 x 478 mm	1272 x 429 x 478 mm	1272 x 576 x 478 mm	1272 x 576 x 478 mm
Version	washbasin on the middle	washbasin on the middle	washbasin on the middle	washbasin on the middle
For combination with	Subway 3.0 4A71 D1/D3/D5	Subway 3.0 4A71 D1/D3/D5	Subway 3.0 4A71 D1/D3/D5	Subway 3.0 4A71 D1/D3/D5
Lighting	-	With LED shelf lighting Lighting 1 x LED drawer lighting / 7,2 W, 1 x LED cabinet lighting / 8,64 W	-	With LED shelf lighting Lighting 1 x LED drawer lighting / 7,2 W, 1 x LED cabinet lighting / 8,64 W
Equipped with	2x pull-out compartment with non-slip mat 2 x accessory dish (small)	2x pull-out compartment with non-slip mat 2 x accessory dish (small)	4x pull-out compartment with non-slip mat 2 x accessory dish (small)	4x pull-out compartment with non-slip mat 2 x accessory dish (small)
Installation	wall-mounted	wall-mounted	wall-mounted	wall-mounted
Scope of delivery	fastening set included	fastening set included	fastening set included	fastening set included
RH, RK, VE, VF, VH, VJ, VL, VM, VN, VQ, VR				

Please note that not all furniture finishes can be combined with handle colour 2 Monochrome look, only the colours VM, VN, VQ and VR are available.

XX = Insert front and body colour
 VE = Brilliant White, VF = Pure White, VL = Volcano Black, VM = Taupe, VN = Cashmere Grey, VQ = Marine Blue, VR = Graphite, RH = Oak Kansas, RK = Stone Oak, VH = Arizona Oak, VJ = Nordic Oak
 Z = Handle code to be indicated
 0 = glossy aluminium, 1 = Volcano Black, 2 = monochrome
 00 = White Matt, BC = BiColour (Black Matt, White Matt)

SUBWAY 3.0

NEW

€ excl. VAT

Produced to order (Please note that it is not always possible to cancel or change orders!), The washbasins are to be ordered separately.

Express Delivery

These products are always available from stock in the colours: **Kansas Oak (RH)** and **Brilliant White (VE)** in handle colour **0 (glossy aluminium)**

	VANITY UNIT	VANITY UNIT	VANITY UNIT	VANITY UNIT
Article number	C601 0Z XX	C601 LZ XX	C602 0Z XX	C602 LZ XX
Dimensions (w x h x d)	1272 x 429 x 478 mm	1272 x 429 x 478 mm	1272 x 576 x 478 mm	1272 x 576 x 478 mm
Version	washbasin on the middle	washbasin on the middle	washbasin on the middle	washbasin on the middle
For combination with	Subway 3.0 4A70 D1/D2/D3/D5	Subway 3.0 4A70 D1/D2/D3/D5	Subway 3.0 4A70 D1/D2/D3/D5	Subway 3.0 4A70 D1/D2/D3/D5
Lighting	-	With LED shelf lighting Lighting 1 x LED drawer lighting / 7,2 W, 1 x LED cabinet lighting / 8,64 W	-	With LED shelf lighting Lighting 1 x LED drawer lighting / 7,2 W, 1 x LED cabinet lighting / 8,64 W
Equipped with	2x pull-out compartment with non-slip mat 2 x accessory dish (small)	2x pull-out compartment with non-slip mat 2 x accessory dish (small)	4x pull-out compartment with non-slip mat 2 x accessory dish (small)	4x pull-out compartment with non-slip mat 2 x accessory dish (small)
Installation	wall-mounted	wall-mounted	wall-mounted	wall-mounted
Scope of delivery	fastening set included	fastening set included	fastening set included	fastening set included
Please note	Vanity washbasin 4A70 D4 only available in combination with a push-open valve	Vanity washbasin 4A70 D4 only available in combination with a push-open valve	Vanity washbasin 4A70 D4 only available in combination with a push-open valve	Vanity washbasin 4A70 D4 only available in combination with a push-open valve
RH, RK, VE, VF, VH, VJ, VL, VM, VN, VQ, VR				

	VANITY UNIT	VANITY UNIT	VANITY UNIT	VANITY UNIT
Article number	C569 0Z XX	C569 LZ XX	C570 0Z XX	C570 LZ XX
Dimensions (w x h x d)	973 x 429 x 478 mm	973 x 429 x 478 mm	973 x 576 x 478 mm	973 x 576 x 478 mm
Version	washbasin on the middle	washbasin on the middle	washbasin on the middle	washbasin on the middle
For combination with	Subway 3.0 4A70 A2/A3/A9	Subway 3.0 4A70 A2/A3/A9	Subway 3.0 4A70 A2/A3/A9	Subway 3.0 4A70 A2/A3/A9
Lighting	-	With LED shelf lighting Lighting 1 x LED drawer lighting / 12,60 W, 1 x LED cabinet lighting / 6,48 W	-	With LED shelf lighting Lighting 1 x LED drawer lighting / 12,60 W, 1 x LED cabinet lighting / 6,48 W
Equipped with	1x pull-out compartment with non-slip mat 2 x accessory dish (small)	1x pull-out compartment with non-slip mat 2 x accessory dish (small)	2x pull-out compartment with non-slip mat 2 x accessory dish (small)	2x pull-out compartment with non-slip mat 2 x accessory dish (small)
Installation	wall-mounted	wall-mounted	wall-mounted	wall-mounted
Scope of delivery	fastening set included	fastening set included	fastening set included	fastening set included
RH, RK, VE, VF, VH, VJ, VL, VM, VN, VQ, VR				

Please note that not all furniture finishes can be combined with handle colour 2 Monochrome look, only the colours VM, VN, VQ and VR are available.

XX = Insert front and body colour
VE = Brilliant White, VF = Pure White, VL = Volcano Black, VM = Taupe, VN = Cashmere Grey, VQ = Marine Blue, VR = Graphite, RH = Oak Kansas, RK = Stone Oak, VH = Arizona Oak, VJ = Nordic Oak

Z = Handle code to be indicated
0 = glossy aluminium, 1 = Volcano Black, 2 = monochrome

00 = White Matt, BC = BiColour (Black Matt, White Matt)

SUBWAY 3.0

NEW

€ excl. VAT

Produced to order (Please note that it is not always possible to cancel or change orders!), The washbasins are to be ordered separately.

Express Delivery

These products are always available from stock in the colours: **Kansas Oak (RH)** and **Brilliant White (VE)** in handle colour **0 (glossy aluminium)**

	VANITY UNIT	VANITY UNIT	VANITY UNIT	VANITY UNIT
Article number	C571 0Z XX	C571 LZ XX	C572 0Z XX	C572 LZ XX
Dimensions (w x h x d)	1001 x 422,5 x 516 mm	1001 x 422,5 x 516 mm	1001 x 422,5 x 516 mm	1001 x 422,5 x 516 mm
Version	With shelf element washbasin on right	With shelf element washbasin on right	With shelf element washbasin on left	With shelf element washbasin on left
For combination with	Subway 3.0 4A70 6F/6G/6L	Subway 3.0 4A70 6F/6G/6L	Subway 3.0 4A70 6F/6G/6L	Subway 3.0 4A70 6F/6G/6L
Lighting	-	With LED shelf lighting Lighting 1 x LED drawer lighting / 3 W, 1 x LED drawer lighting / 7,20 W, 1 x LED cabinet lighting / 6,48 W	-	With LED shelf lighting Lighting 1 x LED drawer lighting / 3 W, 1 x LED drawer lighting / 7,20 W, 1 x LED cabinet lighting / 6,48 W
Equipped with	2x pull-out compartment with non-slip mat 2 x accessory dish (small) 1 x shelf unit on left	2x pull-out compartment with non-slip mat 2 x accessory dish (small) 1 x shelf unit on left	2x pull-out compartment with non-slip mat 2 x accessory dish (small) 1 x shelf unit on right	2x pull-out compartment with non-slip mat 2 x accessory dish (small) 1 x shelf unit on right
Installation	wall-mounted	wall-mounted	wall-mounted	wall-mounted
Scope of delivery	fastening set included	fastening set included	fastening set included	fastening set included
RH, RK, VE, VF, VH, VJ, VL, VM, VN, VQ, VR				

	VANITY UNIT	VANITY UNIT	VANITY UNIT	VANITY UNIT
Article number	C573 0Z XX	C573 LZ XX	C574 0Z XX	C574 LZ XX
Dimensions (w x h x d)	772 x 429 x 478 mm	772 x 429 x 478 mm	772 x 576 x 478 mm	772 x 576 x 478 mm
Version	washbasin on the middle	washbasin on the middle	washbasin on the middle	washbasin on the middle
For combination with	Subway 3.0 4A70 80/81/83	Subway 3.0 4A70 80/81/83	Subway 3.0 4A70 80/81/83	Subway 3.0 4A70 80/81/83
Lighting	-	With LED shelf lighting Lighting 1 x LED drawer lighting / 9 W, 1 x LED cabinet lighting / 5,04 W	-	With LED shelf lighting Lighting 1 x LED drawer lighting / 9 W, 1 x LED cabinet lighting / 5,04 W
Equipped with	1x pull-out compartment with non-slip mat 2 x accessory dish (small)	1x pull-out compartment with non-slip mat 2 x accessory dish (small)	2x pull-out compartment with non-slip mat 2 x accessory dish (small)	2x pull-out compartment with non-slip mat 2 x accessory dish (small)
Installation	wall-mounted	wall-mounted	wall-mounted	wall-mounted
Scope of delivery	fastening set included	fastening set included	fastening set included	fastening set included
RH, RK, VE, VF, VH, VJ, VL, VM, VN, VQ, VR				

Please note that not all furniture finishes can be combined with handle colour 2 Monochrome look, only the colours VM, VN, VQ and VR are available.

XX = Insert front and body colour
VE = Brilliant White, VF = Pure White, VL = Volcano Black, VM = Taupe, VN = Cashmere Grey, VQ = Marine Blue, VR = Graphite, RH = Oak Kansas, RK = Stone Oak, VH = Arizona Oak, VJ = Nordic Oak

Z = Handle code to be indicated
0 = glossy aluminium, 1 = Volcano Black, 2 = monochrome

00 = White Matt, BC = BiColour (Black Matt, White Matt)

SUBWAY 3.0

SUBWAY 3.0

NEW

€ excl. VAT

Produced to order (Please note that it is not always possible to cancel or change orders!), The washbasins are to be ordered separately.

Express Delivery

These products are always available from stock in the colours: **Kansas Oak (RH)** and **Brilliant White (VE)** in handle colour **0 (glossy aluminium)**

	VANITY UNIT	VANITY UNIT	VANITY UNIT	VANITY UNIT
Article number	C575 0Z XX	C575 LZ XX	C576 0Z XX	C576 LZ XX
Dimensions (w x h x d)	622 x 429 x 478 mm	622 x 429 x 478 mm	622 x 576 x 478 mm	622 x 576 x 478 mm
Version	washbasin on the middle	washbasin on the middle	washbasin on the middle	washbasin on the middle
For combination with	Subway 3.0 4A70 65/66/72	Subway 3.0 4A70 65/66/72	Subway 3.0 4A70 65/66/72	Subway 3.0 4A70 65/66/72
Lighting	-	With LED shelf lighting Lighting 1 x LED drawer lighting / 7,20 W, 1 x LED cabinet lighting / 3,96 W	-	With LED shelf lighting Lighting 1 x LED drawer lighting / 7,20 W, 1 x LED cabinet lighting / 3,96 W
Equipped with	1x pull-out compartment with non-slip mat 1 x accessory dish (small)	1x pull-out compartment with non-slip mat 1 x accessory dish (small)	2x pull-out compartment with non-slip mat 1 x accessory dish (small)	2x pull-out compartment with non-slip mat 1 x accessory dish (small)
Installation	wall-mounted	wall-mounted	wall-mounted	wall-mounted
Scope of delivery	fastening set included	fastening set included	fastening set included	fastening set included
RH, RK, VE, VF, VH, VJ, VL, VM, VN, VQ, VR				
	VANITY UNIT	VANITY UNIT	VANITY UNIT	VANITY UNIT
Article number	C577 0Z XX	C577 LZ XX	C578 0Z XX	C578 LZ XX
Dimensions (w x h x d)	572 x 429 x 478 mm	572 x 429 x 478 mm	572 x 576 x 478 mm	572 x 576 x 478 mm
Version	washbasin on the middle	washbasin on the middle	washbasin on the middle	washbasin on the middle
For combination with	Subway 3.0 4A70 60/61/67	Subway 3.0 4A70 60/61/67	Subway 3.0 4A70 60/61/67	Subway 3.0 4A70 60/61/67
Lighting	-	With LED shelf lighting Lighting 1 x LED drawer lighting / 6 W, 1 x LED cabinet lighting / 3,60 W	-	With LED shelf lighting Lighting 1 x LED drawer lighting / 6 W, 1 x LED cabinet lighting / 3,60 W
Equipped with	1x pull-out compartment with non-slip mat 1 x accessory dish (small)	1x pull-out compartment with non-slip mat 1 x accessory dish (small)	2x pull-out compartment with non-slip mat 1 x accessory dish (small)	2x pull-out compartment with non-slip mat 1 x accessory dish (small)
Installation	wall-mounted	wall-mounted	wall-mounted	wall-mounted
Scope of delivery	fastening set included	fastening set included	fastening set included	fastening set included
RH, RK, VE, VF, VH, VJ, VL, VM, VN, VQ, VR				

SUBWAY 3.0

Please note that not all furniture finishes can be combined with handle colour 2 Monochrome look, only the colours VM, VN, VQ and VR are available.

XX = Insert front and body colour
VE = Brilliant White, VF = Pure White, VL = Volcano Black, VM = Taupe, VN = Cashmere Grey, VQ = Marine Blue, VR = Graphite, RH = Oak Kansas, RK = Stone Oak, VH = Arizona Oak, VJ = Nordic Oak

Z = Handle code to be indicated
0 = glossy aluminium, 1 = Volcano Black, 2 = monochrome

00 = White Matt, BC = BiColour (Black Matt, White Matt)

SUBWAY 3.0

NEW

€ excl. VAT

Produced to order (Please note that it is not always possible to cancel or change orders!), The washbasins are to be ordered separately.

Express Delivery

These products are always available from stock in the colours: **Kansas Oak (RH)** and **Brilliant White (VE)** in handle colour **0 (glossy aluminium)**

	VANITY UNIT	VANITY UNIT	VANITY UNIT	VANITY UNIT
Article number	C579 0Z XX	C579 LZ XX	C580 0Z XX	C580 LZ XX
Dimensions (w x h x d)	523 x 429 x 447,5 mm	523 x 429 x 447,5 mm	473 x 429 x 407,5 mm	473 x 429 x 407,5 mm
Version	washbasin on the middle	washbasin on the middle	washbasin on the middle	washbasin on the middle
For combination with	Subway 3.0 4A70 F4/F5/F10	Subway 3.0 4A70 F4/F5/F10	Subway 3.0 4370 FF/FG	Subway 3.0 4370 FF/FG
Lighting	-	With LED shelf lighting Lighting 1 x LED drawer lighting / 5,40 W, 1 x LED cabinet lighting / 3,24 W	-	With LED shelf lighting Lighting 1 x LED drawer lighting / 4,80 W, 1 x LED cabinet lighting / 2,88 W
Equipped with	1x pull-out compartment with non-slip mat 1 x accessory dish (small)	1x pull-out compartment with non-slip mat 1 x accessory dish (small)	1x pull-out compartment with non-slip mat 1 x accessory dish (small)	1x pull-out compartment with non-slip mat 1 x accessory dish (small)
Installation	wall-mounted	wall-mounted	wall-mounted	wall-mounted
Scope of delivery	fastening set included	fastening set included	fastening set included	fastening set included
RH, RK, VE, VF, VH, VJ, VL, VM, VN, VQ, VR				

	VANITY UNIT	VANITY UNIT	VANITY UNIT	VANITY UNIT
Article number	C581 0Z XX	C582 0Z XX	C583 0Z XX	C584 0Z XX
Dimensions (w x h x d)	423 x 429 x 377,5 mm	423 x 429 x 377,5 mm	351 x 429 x 309 mm	351 x 429 x 309 mm
Version	washbasin on the middle	washbasin on the middle	washbasin on the middle	washbasin on the middle
Hinges	hinges on left	hinges on right	hinges on left	hinges on right
For combination with	Subway 3.0 4370 FK/FL	Subway 3.0 4370 FK/FL	Subway 3.0 4370 37/42	Subway 3.0 4370 37/42
Equipped with	1x door	1x door	1x door	1x door
Installation	wall-mounted	wall-mounted	wall-mounted	wall-mounted
Scope of delivery	fastening set included	fastening set included	fastening set included	fastening set included
RH, RK, VE, VF, VH, VJ, VL, VM, VN, VQ, VR				

Please note that not all furniture finishes can be combined with handle colour 2 Monochrome look, only the colours VM, VN, VQ and VR are available.

XX = Insert front and body colour

VE = Brilliant White, VF = Pure White, VL = Volcano Black, VM = Taupe, VN = Cashmere Grey, VQ = Marine Blue, VR = Graphite, RH = Oak Kansas, RK = Stone Oak, VH = Arizona Oak, VJ = Nordic Oak

Z = Handle code to be indicated

0 = glossy aluminium, 1 = Volcano Black, 2 = monochrome

00 = White Matt, BC = BiColour (Black Matt, White Matt)

SUBWAY 3.0

NEW

€ excl. VAT

Produced to order (Please note that it is not always possible to cancel or change orders!), The washbasins are to be ordered separately.

Express Delivery

These products are always available from stock in the colours: **Kansas Oak (RH)** and **Brilliant White (VE)** in handle colour **0 (glossy aluminium)**

	TALL CABINET	TALL CABINET	TALL CABINET	TALL CABINET
Article number	C586 0Z XX	C587 0Z XX	C588 0Z XX	C589 0Z XX
Dimensions (w x h x d)	400 x 1710 x 362 mm	400 x 1710 x 362 mm	400 x 1710 x 362 mm	400 x 1710 x 362 mm
Hinges	hinges on left	hinges on right	hinges on left	hinges on right
Equipped with	2x door 1x fixed shelf 4x glass shelf	2x door 1x fixed shelf 4x glass shelf	2x door 1x open compartment 2x fixed shelf 3x glass shelf	2x door 1x open compartment 2x fixed shelf 3x glass shelf
Installation	wall-mounted	wall-mounted	wall-mounted	wall-mounted
Scope of delivery	fastening set included	fastening set included	fastening set included	fastening set included
RH, RK, VE, VF, VH, VJ, VL, VM, VN, VQ, VR				

	TALL CABINET	TALL CABINET	TALL CABINET	TALL CABINET
Article number	C590 0Z XX	C591 0Z XX	C592 0Z XX	C593 0Z XX
Dimensions (w x h x d)	400 x 1710 x 362 mm	400 x 1710 x 362 mm	400 x 1710 x 362 mm	400 x 1710 x 362 mm
Hinges	hinges on left	hinges on right	hinges on left	hinges on right
Equipped with	2x door 1x pull-out compartment 1x fixed shelf 3x glass shelf	2x door 1x pull-out compartment 1x fixed shelf 3x glass shelf	1x door 1x laundry flap 1x fixed shelf 2x glass shelf	1x door 1x laundry flap 1x fixed shelf 2x glass shelf
Installation	wall-mounted	wall-mounted	wall-mounted	wall-mounted
Scope of delivery	fastening set included	fastening set included	fastening set included	fastening set included
RH, RK, VE, VF, VH, VJ, VL, VM, VN, VQ, VR				

	SIDE CABINET	SIDE CABINET	MEDIUM-HEIGHT CABINET	MEDIUM-HEIGHT CABINET
Article number	C594 0Z XX	C595 0Z XX	C598 0Z XX	C599 0Z XX
Dimensions (w x h x d)	400 x 860 x 362 mm	400 x 860 x 362 mm	574 x 1200 x 362 mm	574 x 1200 x 362 mm
Hinges	hinges on left	hinges on right	hinges on left	hinges on right
Equipped with	1x door 1x pull-out compartment 1x glass shelf	1x door 1x pull-out compartment 1x glass shelf	2x door 1x open compartment 6x glass shelf	2x door 1x open compartment 6x glass shelf
Installation	wall-mounted	wall-mounted	wall-mounted	wall-mounted
Scope of delivery	fastening set included	fastening set included	fastening set included	fastening set included
RH, RK, VE, VF, VH, VJ, VL, VM, VN, VQ, VR				

Please note that not all furniture finishes can be combined with handle colour 2 Monochrome look, only the colours VM, VN, VQ and VR are available.

XX = Insert front and body colour
VE = Brilliant White, VF = Pure White, VL = Volcano Black, VM = Taupe, VN = Cashmere Grey, VQ = Marine Blue, VR = Graphite, RH = Oak Kansas, RK = Stone Oak, VH = Arizona Oak, VJ = Nordic Oak

Z = Handle code to be indicated
0 = glossy aluminium, 1 = Volcano Black, 2 = monochrome

00 = White Matt, BC = BiColour (Black Matt, White Matt)

SUBWAY 3.0

NEW

€ excl. VAT

Produced to order (Please note that it is not always possible to cancel or change orders!), The washbasins are to be ordered separately.

Express Delivery

These products are always available from stock in the colours: **Kansas Oak (RH)** and **Brilliant White (VE)** in handle colour **0 (glossy aluminium)**

	SIDEBOARD	MIRROR SHELF	MIRROR SHELF	
Article number	C600 0Z XX	C596 00 XX	C597 00 XX	
Dimensions (w x h x d)	805 x 423 x 256 mm	450 x 1700 x 300 mm	450 x 1700 x 300 mm	
Version	-	with shelf on left	with shelf on right	
Equipped with	2x door	1 x clothes hooks 3x fixed shelf	1 x clothes hooks 3x fixed shelf	
Installation	wall-mounted	wall-mounted	wall-mounted	
Scope of delivery	fastening set included	fastening set included	fastening set included	
RH, RK, VE, VF, VH, VJ, VL, VM, VN, VQ, VR				
	MIRROR	MIRROR	MIRROR	MIRROR
Article number	A463 16 YY	A463 14 YY	A463 13 YY	A463 12 YY
Dimensions (w x h x d)	1600 x 750 x 47,5 mm	1400 x 750 x 47,5 mm	1300 x 750 x 47,5 mm	1200 x 750 x 47,5 mm
Lighting	with all-round LED lighting (can be replaced) Lighting 1x LED / 40,8 W	with all-round LED lighting (can be replaced) Lighting 1x LED / 36,96 W	with all-round LED lighting (can be replaced) Lighting 1x LED / 35,04 W	with all-round LED lighting (can be replaced) Lighting 1x LED / 33,12 W
Equipped with	1 x aluminium frame	1 x aluminium frame	1 x aluminium frame	1 x aluminium frame
Note on standard	IP 44	IP 44	IP 44	IP 44
Scope of delivery	fastening set included	fastening set included	fastening set included	fastening set included
00, BC				
	MIRROR	MIRROR	MIRROR	MIRROR
Article number	A463 10 YY	A463 80 YY	A463 65 YY	A463 60 YY
Dimensions (w x h x d)	1000 x 750 x 47,5 mm	800 x 750 x 47,5 mm	650 x 750 x 47,5 mm	600 x 750 x 47,5 mm
Lighting	with all-round LED lighting (can be replaced) Lighting 1x LED / 29,28 W	with all-round LED lighting (can be replaced) Lighting 1x LED / 25,44 W	with all-round LED lighting (can be replaced) Lighting 1x 22,56 W	with all-round LED lighting (can be replaced) Lighting 1x LED / 21,6 W
Equipped with	1 x aluminium frame	1 x aluminium frame	1 x aluminium frame	1 x aluminium frame
Note on standard	IP 44	IP 44	IP 44	IP 44
Scope of delivery	fastening set included	fastening set included	fastening set included	fastening set included
00, BC				

Please note that not all furniture finishes can be combined with handle colour 2 Monochrome look, only the colours VM, VN, VQ and VR are available.

XX = Insert front and body colour
VE = Brilliant White, VF = Pure White, VL = Volcano Black, VM = Taupe, VN = Cashmere Grey, VQ = Marine Blue, VR = Graphite, RH = Oak Kansas, RK = Stone Oak, VH = Arizona Oak, VJ = Nordic Oak

Z = Handle code to be indicated
0 = glossy aluminium, 1 = Volcano Black, 2 = monochrome

00 = White Matt, BC = BiColour (Black Matt, White Matt)

SUBWAY 3.0

NEW

€ excl. VAT

Produced to order (Please note that it is not always possible to cancel or change orders!), The washbasins are to be ordered separately.

Express Delivery

These products are always available from stock in the colours: **Kansas Oak (RH)** and **Brilliant White (VE)** in handle colour **0 (glossy aluminium)**

	MIRROR	MIRROR	MIRROR
			
			
Article number	A463 50 YY	A464 91 YY	A464 71 YY
Dimensions (w x h x d)	500 x 750 x 47,5 mm	910 x 910 x 45 mm	712 x 712 x 45 mm
Lighting	with all-round LED lighting (can be replaced) Lighting 1x 19,68 W	with all-round LED lighting (cannot be replaced) Lighting 1x 23,52 W	with all-round LED lighting (cannot be replaced) Lighting 1x 17,28 W
Equipped with	1 x aluminium frame	1 x aluminium frame	1 x aluminium frame
Note on standard	IP 44	IP 44	IP 44
Scope of delivery	fastening set included	fastening set included	fastening set included
00, BC			
	ZIGBEE® HOME AUTOMATION KIT FOR VANITY UNIT	ZIGBEE® HOME AUTOMATION KIT FOR MIRRORS	
			
	 	 	
Article number	C585 00 00	C004 00 00	
Scope of delivery	not included in scope of delivery	not included in scope of delivery	

SUBWAY 3.0

Please note that not all furniture finishes can be combined with handle colour 2 Monochrome look, only the colours VM, VN, VQ and VR are available.

XX = Insert front and body colour

VE = Brilliant White, VF = Pure White, VL = Volcano Black, VM = Taupe, VN = Cashmere Grey, VQ = Marine Blue, VR = Graphite, RH = Oak Kansas, RK = Stone Oak, VH = Arizona Oak, VJ = Nordic Oak

Z = Handle code to be indicated

0 = glossy aluminium, 1 = Volcano Black, 2 = monochrome

00 = White Matt, BC = BiColour (Black Matt, White Matt)

SUBWAY 2.0

Sanitaryware and Bathroom Furniture

- Mainstream segment
- Matching furniture programme Subway 2.0
- Selected washbasins also match the furniture programme Legato
- Designed to match all mirror collections
- Designed to match all mirror cabinet collections

PRO.VILLEROY-BOCH.COM/TECHNICALDRAWINGS



SUBWAY 2.0

Ceramic colours

01 = White Alpin	R1 = White Alpin CeramicPlus	R3 = Pergamon CeramicPlus	T2 = White Alpin AntiBac CeramicPlus	RW = Stone White CeramicPlus	S5 = Ebony CeramicPlus	i4 = Graphite CeramicPlus

Front- / Body colours

DH = Glossy White	FP = Glossy Grey	MS = White Matt	PD = Black Matt Lacquer	VG = Truffle Grey	VK = Soft Grey	E8 = White Wood	PN = Elm Impresso	VH = Arizona Oak	VJ = Nordic Oak

Top colours

R = Glass Silver Grey	S = Glass White

SUBWAY 2.0



€ excl. VAT

Registered design

Please order tap fittings and soap dispenser separately

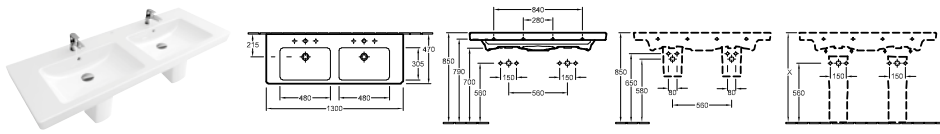

DOUBLE VANITY WASHBASIN



Article number	Description	01	plus R1	plus R3	plus T2		pcs/ pal.	kg/ pc.
7175 D0 XX	1300 x 470 mm 2x    			-	-	-	8	40,3



wall fixation, matching furniture programme: Subway 2.0

For further information about matching valves and CAP, see pages 380-383

5244 00 XX	TRAP COVER cannot be combined with 3-hole tap fittings, incl. fastening set "SmartFix"					-	-	40	5,59
9221 49 00	WASHBASIN INSTALLATION ELEMENT 525 x 1120 x 75 mm For further ViConnect models, see pages 368-379		-	-	-	-	-	10	8,05

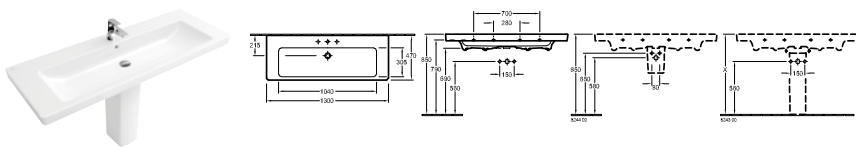

VANITY WASHBASIN



Article number	Description	01	plus R1	plus R3	plus T2		pcs/ pal.	kg/ pc.
7176 D0 XX	1300 x 470 mm   			-	-	-	8	39,2



wall fixation, matching furniture programme: Subway 2.0

For further information about matching valves and CAP, see pages 380-383

5244 00 XX	TRAP COVER cannot be combined with 3-hole tap fittings, incl. fastening set "SmartFix"					-	-	40	5,59
9221 49 00	WASHBASIN INSTALLATION ELEMENT 525 x 1120 x 75 mm For further ViConnect models, see pages 368-379		-	-	-	-	-	10	8,05

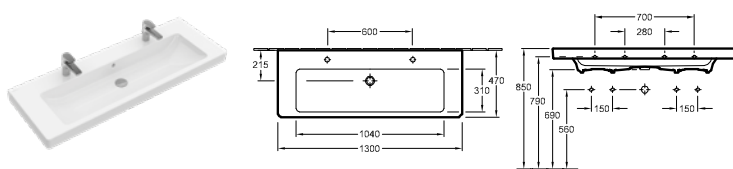
VANITY WASHBASIN



Article number	Description	01	plus R1	plus R3	plus T2		pcs/ pal.	kg/ pc.
7176 D2 XX	1300 x 470 mm 2x  			-	-	-	8	39,2

wall fixation, with 2 single-lever mixers and turn-knob operation or in conjunction with toggle valve, as well as push-open valve, please do not exceed a flow rate of max. 7.5 l/min per tap fitting., matching furniture programme: Subway 2.0

For further information about matching valves and CAP, see pages 380-383

9221 49 00	WASHBASIN INSTALLATION ELEMENT 525 x 1120 x 75 mm For further ViConnect models, see pages 368-379		-	-	-	-	-	10	8,05
------------	--	---	---	---	---	---	---	----	------

XX = Colour code to be indicated

01 = White Alpin, R1 = White Alpin CeramicPlus, R3 = Pergamon CeramicPlus, T2 = White Alpin AntiBac CeramicPlus, RW = Stone White CeramicPlus, S5 = Ebony CeramicPlus, i4 = Graphite CeramicPlus

SUBWAY 2.0

€ excl. VAT

Registered design

Please order tap fittings and soap dispenser separately

VANITY WASHBASIN

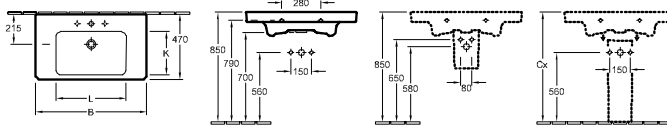

Article no.	B	K	L
7175A0XX	1000	305	550
717580XX	800	300	500

Article number	Description	01	plus R1	plus R3	plus T2	pcs/pal.	kg/pc.
7175 A0 XX	1000 x 470 mm			-	-	-	6 27,45
7175 80 XX	800 x 470 mm			-	-	-	12 23,8

wall fixation, matching furniture programme: Subway 2.0

For further information about matching valves and CAP, see pages 380-383

5244 00 XX	TRAP COVER cannot be combined with 3-hole tap fittings, incl. fastening set "SmartFix"				-	-	40 5,59
9221 49 00	WASHBASIN INSTALLATION ELEMENT 525 x 1120 x 75 mm For further ViConnect models, see pages 368-379		-	-	-	-	10 8,05

VANITY WASHBASIN

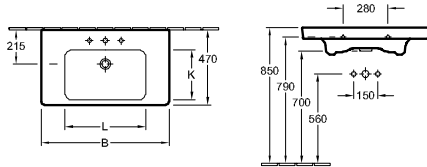

Article no.	B	K	L
71751GXX	1000	305	550
71758GXX	800	300	500

Article number	Description	01	plus R1	plus R3	plus T2	pcs/pal.	kg/pc.
7175 1G XX	1000 x 470 mm			-	-	-	6 26,6
7175 8G XX	800 x 470 mm matching furniture programme: Legato			-	-	-	12 23,8

ground underside, wall fixation, incl. template

For further information about matching valves and CAP, see pages 380-383

9221 49 00	WASHBASIN INSTALLATION ELEMENT 525 x 1120 x 75 mm For further ViConnect models, see pages 368-379		-	-	-	-	10 8,05
------------	--	--	---	---	---	---	---------

WASHBASINS

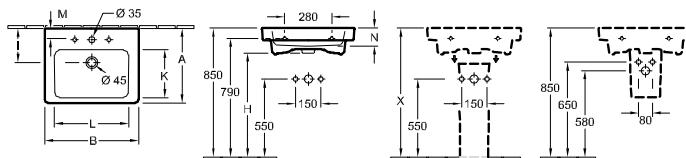

Article no.	A	B	H	I	K	L	M	N
711365XX	470	650	700	215	300	500	60	105
711360XX	470	600	700	215	300	465	65	105
711355XX	440	550	705	200	280	430	70	100

Article number	Description	01	plus R1	plus R3	plus T2	pcs/pal.	kg/pc.
7113 65 XX	650 x 470 mm			-	-	-	21 20,76
7113 60 XX	600 x 470 mm			-	-	-	16 18,58
7113 55 XX	550 x 440 mm			-	-	-	24 17,31

For further information about matching valves and CAP, see pages 380-383

5244 00 XX	TRAP COVER cannot be combined with 3-hole tap fittings, incl. fastening set "SmartFix"				-	-	40 5,59
9221 49 00	WASHBASIN INSTALLATION ELEMENT 525 x 1120 x 75 mm For further ViConnect models, see pages 368-379		-	-	-	-	10 8,05

XX = Colour code to be indicated

01 = White Alpin, R1 = White Alpin CeramicPlus, R3 = Pergamon CeramicPlus, T2 = White Alpin AntiBac CeramicPlus, RW = Stone White CeramicPlus, S5 = Ebony CeramicPlus, i4 = Graphite CeramicPlus

SUBWAY 2.0

€ excl. VAT

Registered design

Please order tap fittings and soap dispenser separately

WASHBASINS

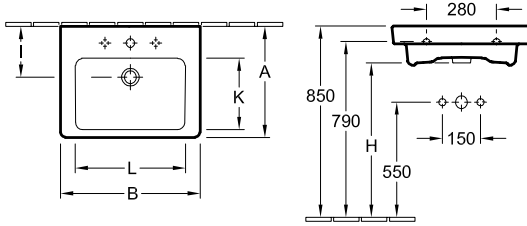

Article no.	A	B	H	I	K	L	M
7113FAXX	470	650	700	215	300	500	70
7113F0XX	470	600	700	215	300	465	65
7113F5XX	440	550	705	200	280	430	70

Article number	Description	01	plus R1	plus R3	plus T2	pcs/ pal.	kg/ pc.
7113 FA XX	650 x 470 mm			-	-	15	20,76
7113 F0 XX	600 x 470 mm			-	-	15	18,58
7113 F5 XX	550 x 440 mm			-	-	21	18,2

wall fixation, for installation with furniture Subway 2.0, matching furniture programme: Subway 2.0

For further information about matching valves and CAP, see pages 380-383

9221 49 00	WASHBASIN INSTALLATION ELEMENT 525 x 1120 x 75 mm For further ViConnect models, see pages 368-379		-	-	-	-	10	8,05
------------	--	--	---	---	---	---	----	------

WASHBASINS

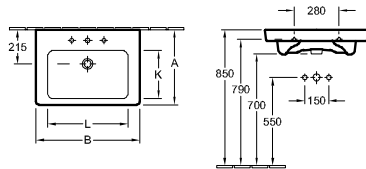

Article no.	A	B	K	L
7113KGXX	470	650	300	500
71136GXX	470	600	300	465

Article number	Description	01	plus R1	plus R3	plus T2	pcs/ pal.	kg/ pc.
7113 KG XX	650 x 470 mm			-	-	15	20,76
7113 6G XX	600 x 470 mm			-	-	15	18,58

ground underside, wall fixation, incl. template, matching furniture programme: Legato

For further information about matching valves and CAP, see pages 380-383

9221 49 00	WASHBASIN INSTALLATION ELEMENT 525 x 1120 x 75 mm For further ViConnect models, see pages 368-379		-	-	-	-	10	8,05
------------	--	--	---	---	---	---	----	------

HANDWASHBASIN

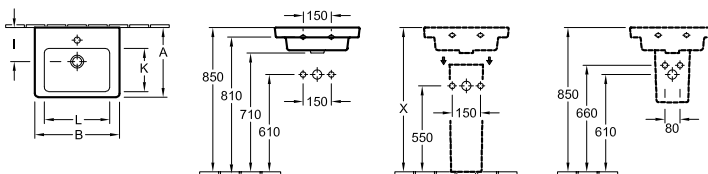

Article no.	A	B	I	K	L
731550XX	400	500	185	250	385
731545XX	370	450	180	230	350

Article number	Description	01	plus R1	plus R3	plus T2	pcs/ pal.	kg/ pc.
7315 50 XX	500 x 400 mm			-	-	48	11,4
7315 45 XX	450 x 370 mm			-	-	36	10,85

wall fixation

For further information about matching valves and CAP, see pages 380-383

5222 00 XX	TRAP COVER cannot be combined with 3-hole tap fittings, fastening set included			-	-	-	50	7,35
9221 49 00	WASHBASIN INSTALLATION ELEMENT 525 x 1120 x 75 mm For further ViConnect models, see pages 368-379		-	-	-	-	10	8,05

XX = Colour code to be indicated

01 = White Alpin, R1 = White Alpin CeramicPlus, R3 = Pergamon CeramicPlus, T2 = White Alpin AntiBac CeramicPlus, RW = Stone White CeramicPlus, S5 = Ebony CeramicPlus, i4 = Graphite CeramicPlus

SUBWAY 2.0

SUBWAY 2.0

€ excl. VAT

Registered design

Please order tap fittings and soap dispenser separately

HANDWASHBASIN

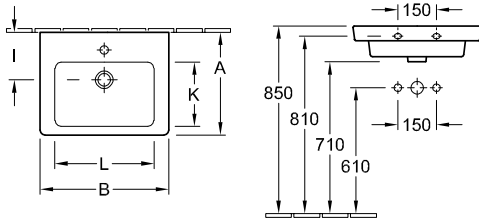

Article no.	A	B	I	K	L
7315F0XX	400	500	185	250	385
7315F5XX	370	450	180	230	350

Article number	Description	01	plus R1	plus R3	plus T2	pcs/pal.	kg/pc.
7315 F0 XX	500 x 400 mm			-	-	36	11,4
7315 F5 XX	450 x 370 mm			-	-	36	10,85

wall fixation, for installation with furniture Subway 2.0, matching furniture programme: Subway 2.0

For further information about matching valves and CAP, see pages 380-383

9221 49 00	WASHBASIN INSTALLATION ELEMENT 525 x 1120 x 75 mm For further ViConnect models, see pages 368-379					10	8,05
------------	--	--	--	--	--	----	------

HANDWASHBASIN

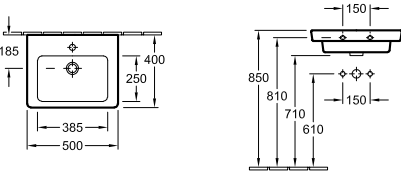

Article number	Description	01	plus R1	plus R3	plus T2	pcs/pal.	kg/pc.
7315 5G XX	500 x 400 mm			-	-	18	11,4

ground underside, wall fixation, incl. template

For further information about matching valves and CAP, see pages 380-383

9221 49 00	WASHBASIN INSTALLATION ELEMENT 525 x 1120 x 75 mm For further ViConnect models, see pages 368-379					10	8,05
------------	--	--	--	--	--	----	------

HANDWASHBASIN

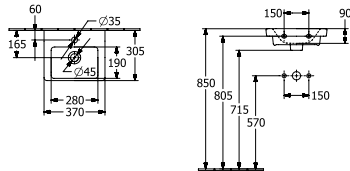

Article number	Description	01	plus R1	plus R3	plus T2	pcs/pal.	kg/pc.
7317 37 XX	370 x 305 mm			-	-	56	8,067

For further information about matching valves, see pages 380-383

9221 49 00	WASHBASIN INSTALLATION ELEMENT 525 x 1120 x 75 mm For further ViConnect models, see pages 368-379					10	8,05
------------	--	--	--	--	--	----	------

XX = Colour code to be indicated

01 = White Alpin, R1 = White Alpin CeramicPlus, R3 = Pergamon CeramicPlus, T2 = White Alpin AntiBac CeramicPlus, RW = Stone White CeramicPlus, S5 = Ebony CeramicPlus, i4 = Graphite CeramicPlus

SUBWAY 2.0

€ excl. VAT

Registered design

Please order tap fittings and soap dispenser separately

CORNER HANDWASHBASIN

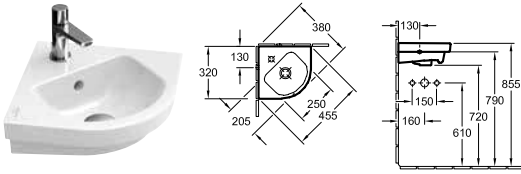

Article number	Description	01	plus R1	plus R3	plus T2		pcs/ pal.	kg/ pc.
7319 45 XX	320 mm side length			-	-	-	85	6,877

For further information about matching valves, see pages 380-383

BIDET

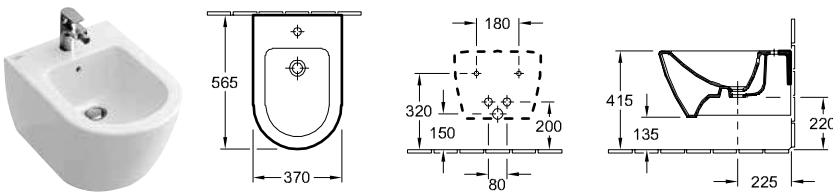

Article number	Description	01	plus R1	plus T2			pcs/ pal.	kg/ pc.
5400 00 XX	370 x 565 mm			-	-	-	16	22

wall-mounted, with fastening set for concealed fastening

For further information about matching valves, see pages 380-383

9953 00 00	FASTENING FRAME (optional)	-	-	-	-	-		2,93
9221 48 00	BIDET INSTALLATION SYSTEM 525 x 1120 x 100 mm	-	-	-	-	-	10	10,54

BIDET COMPACT

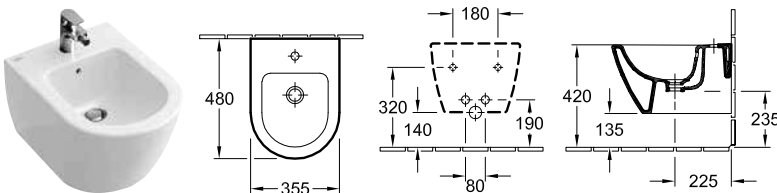

Article number	Description	01	plus R1	plus T2			pcs/ pal.	kg/ pc.
5406 00 XX	355 x 480 mm			-	-	-	16	17,1

wall-mounted, with fastening set for concealed fastening

For further information about matching valves, see pages 380-383

9953 00 00	FASTENING FRAME (optional)	-	-	-	-	-		2,93
9221 48 00	BIDET INSTALLATION SYSTEM 525 x 1120 x 100 mm	-	-	-	-	-	10	10,54

XX = Colour code to be indicated

01 = White Alpin, R1 = White Alpin CeramicPlus, R3 = Pergamon CeramicPlus, T2 = White Alpin AntiBac CeramicPlus, RW = Stone White CeramicPlus, S5 = Ebony CeramicPlus, i4 = Graphite CeramicPlus

SUBWAY 2.0





€ excl. VAT

Registered design

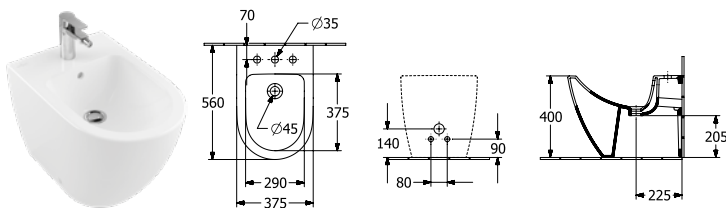
Please order tap fittings and soap dispenser separately

BIDET







Article number	Description	01	plus R1	plus T2			pcs/pal.	kg/pc.
5401 00 XX	370 x 560 mm   						12	27
floor-standing, back to wall, with fastening set for concealed fastening For further information about matching valves, see pages 380-383								
9208 31 00	INSTALLATION KIT (optional) for installation close to the wall	-	-	-	-	-		0,305
9208 72 00	SIPHON (optional) with extension piece	-	-	-	-	-		0,35
9221 48 00	BIDET INSTALLATION SYSTEM  525 x 1120 x 100 mm For further ViConnect models, see pages 368-379	-	-	-	-	-	10	10,54

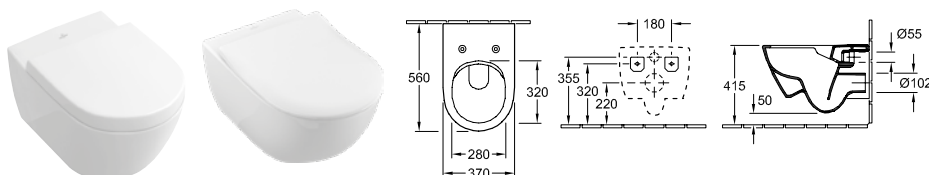



WASHDOWN TOILET, RIMLESS

DirectFlush



Article number	Description	01	plus R1	plus R3	plus T2	plus RW, S5, i4		pcs/pal.	kg/pc.
5614 R0 XX	370 x 560 mm    						-	12	25,2

wall-mounted, horizontal outlet, incl. fastening set "SupraFix 3.0", with water-saving AQUAREDUCT® system: flush volume 3 / 4,5 litres, not suitable for installation with flush valves

8M42 S1 XX	TOILET SEAT AND COVER  with QuickRelease and SoftClosing hinges, hinges in stainless steel		-	-	-	-	-		2,63
9M68 S1 XX	TOILET SEAT AND COVER with QuickRelease and SoftClosing hinges, hinges in stainless steel		-	-	-	-	-	90	3,647
9M78 S1 XX	TOILET SEAT AND COVER SLIMSEAT  with QuickRelease and SoftClosing hinges, hinges in stainless steel		-	-	-	-	-	90	2,968
9M68 Q1 XX	TOILET SEAT AND COVER with QuickRelease hinges, hinges in stainless steel		-	-	-	-	-	90	3,647
9M74 61 01	SEAT hinges in stainless steel		-	-	-	-	-	90	1,35
9222 87 00	VIPROTECT SOUNDPROOFING SET (optional) incl. accessories		-	-	-	-	-	600	0,086
9224 65 00	TOILET INSTALLATION SYSTEM for dry-wall construction, low  450 x 1120 x 165 mm For further ViConnect models, see pages 368-379		-	-	-	-	-	8	19,78
9224 27 00	TOILET INSTALLATION SYSTEM for dry-wall construction, standard height  525 x 1120 x 135 mm For further ViConnect models, see pages 368-379		-	-	-	-	-	10	15,8

XX = Colour code to be indicated

01 = White Alpin, R1 = White Alpin CeramicPlus, R3 = Pergamon CeramicPlus, T2 = White Alpin AntiBac CeramicPlus, RW = Stone White CeramicPlus, S5 = Ebony CeramicPlus, i4 = Graphite CeramicPlus

SUBWAY 2.0

€ excl. VAT

Registered design

Please order tap fittings and soap dispenser separately

WASHDOWN TOILET, RIMLESS

DirectFlush, ViFresh

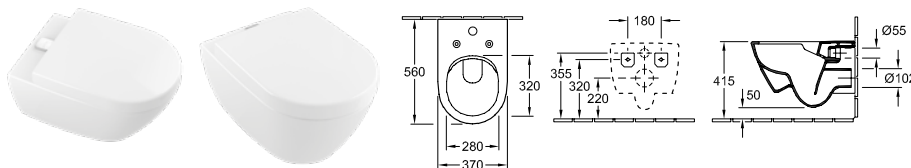

Article number	Description	01	plus R1	plus T2		pcs/ pal.	kg/ pc.
5614 A1 XX	370 x 560 mm <div style="display: flex; justify-content: space-around; align-items: center;"> SupraFix 3.0 Direct Flush ViFresh AntiBac </div>				-	12	25,2
wall-mounted, horizontal outlet, incl. ViFresh Technology, comprises 2 holders (1x for rim-block, 1x for gel cleaner) and 2 screw-on lids (1x white, 1x chrome), incl. fastening set "SupraFix 3.0", with water-saving AQUAREDUCT® system: flush volume 3 / 4,5 litres, not suitable for installation with flush valves							
9M78 S1 XX	TOILET SEAT AND COVER SLIMSEAT with QuickRelease and SoftClosing hinges, hinges in stainless steel		-	-	-	90	2,968
9M68 Q1 XX	TOILET SEAT AND COVER with QuickRelease hinges, hinges in stainless steel		-	-	-	90	3,647
9M68 S1 XX	TOILET SEAT AND COVER with QuickRelease and SoftClosing hinges, hinges in stainless steel		-	-	-	90	3,647
9M74 61 01	SEAT hinges in stainless steel		-	-	-	90	1,35
9222 87 00	VIPROTECT SOUNDPROOFING SET (optional) incl. accessories	-	-	-		600	0,086
9224 27 00	TOILET INSTALLATION SYSTEM for dry-wall construction, standard height 525 x 1120 x 135 mm For further ViConnect models, see pages 368-379		-	-	-	10	15,8

XX = Colour code to be indicated

01 = White Alpin, R1 = White Alpin CeramicPlus, R3 = Pergamon CeramicPlus, T2 = White Alpin AntiBac CeramicPlus, RW = Stone White CeramicPlus, S5 = Ebony CeramicPlus, i4 = Graphite CeramicPlus

SUBWAY 2.0

€ excl. VAT

Registered design

Please order tap fittings and soap dispenser separately

COMBI-PACK

DirectFlush

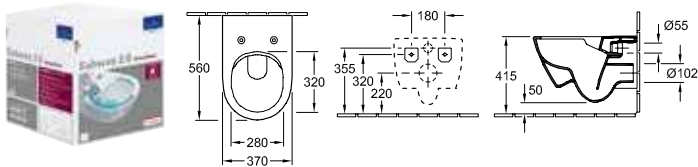

Article number	Description	01	 R1	 T2		pcs/ pal.	kg/ pc.
5614 R2 XX	individual packaging materials, wall-mounted, horizontal outlet composed of: Washdown WC DirectFlush 5614 R0 XX, SlimSeat with QuickRelease and SoftClosing hinges 9M78 S1 01	    		-	-	12	25,6

XX = Colour code to be indicated

01 = White Alpin, R1 = White Alpin CeramicPlus, R3 = Pergamon CeramicPlus, T2 = White Alpin AntiBac CeramicPlus, RW = Stone White CeramicPlus, S5 = Ebony CeramicPlus, i4 = Graphite CeramicPlus

SUBWAY 2.0

€ excl. VAT

Registered design

Please order tap fittings and soap dispenser separately

WASHDOWN TOILET

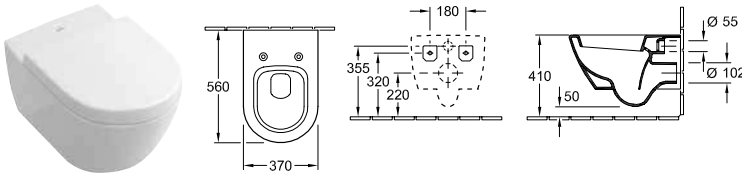

Article number	Description	01	plus R1	plus T2		pcs/ pal.	kg/ pc.
5600 10 XX	370 x 560 mm					12	25,95
wall-mounted, horizontal outlet, incl. fastening set "SupraFix 3.0", with water-saving AQUAREDUCT® system: flush volume 3 / 4,5 litres							
9M78 S1 XX	TOILET SEAT AND COVER SLIMSEAT with QuickRelease and SoftClosing hinges, hinges in stainless steel					90	2,968
9M68 S1 XX	TOILET SEAT AND COVER with QuickRelease and SoftClosing hinges, hinges in stainless steel					90	3,647
9M68 Q1 XX	TOILET SEAT AND COVER with QuickRelease hinges, hinges in stainless steel					90	3,647
9M74 61 01	SEAT hinges in stainless steel					90	1,35
9222 87 00	VIPROTECT SOUNDPROOFING SET (optional) incl. accessories					600	0,086
9224 65 00	TOILET INSTALLATION SYSTEM for dry-wall construction, low 450 x 1120 x 165 mm For further ViConnect models, see pages 368-379					8	19,78
9224 27 00	TOILET INSTALLATION SYSTEM for dry-wall construction, standard height 525 x 1120 x 135 mm For further ViConnect models, see pages 368-379					10	15,8

XX = Colour code to be indicated

01 = White Alpin, R1 = White Alpin CeramicPlus, R3 = Pergamon CeramicPlus, T2 = White Alpin AntiBac CeramicPlus, RW = Stone White CeramicPlus, S5 = Ebony CeramicPlus, i4 = Graphite CeramicPlus

SUBWAY 2.0

€ excl. VAT

Registered design

Please order tap fittings and soap dispenser separately

WASHDOWN TOILET COMPACT, RIMLESS

DirectFlush

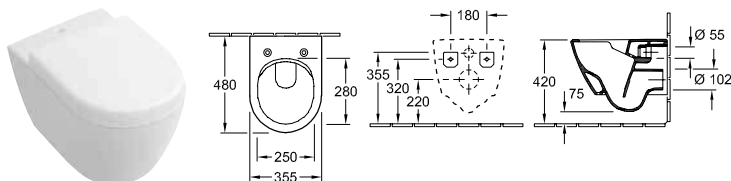

Article number	Description	01	plus R1	plus T2		pcs/ pal.	kg/ pc.
5606 R0 XX	355 x 480 mm 			-	-	12	21,9
wall-mounted, horizontal outlet, incl. fastening set "SupraFix compact", with water-saving AQUAREDUCT® system: flush volume 3 / 4,5 litres, not suitable for installation with flush valves							
9M69 S1 XX	TOILET SEAT AND COVER COMPACT with QuickRelease and SoftClosing hinges, hinges in stainless steel		-	-	-	90	2,88
9M69 Q1 XX	TOILET SEAT AND COVER COMPACT with QuickRelease hinges, hinges in stainless steel		-	-	-	90	2,88
9222 87 00	VIPROTECT SOUNDPROOFING SET (optional) incl. accessories	-	-	-		600	0,086
9224 27 00	TOILET INSTALLATION SYSTEM for dry-wall construction, standard height 525 x 1120 x 135 mm For further ViConnect models, see pages 368-379 	-	-	-		10	15,8

XX = Colour code to be indicated

01 = White Alpin, R1 = White Alpin CeramicPlus, R3 = Pergamon CeramicPlus, T2 = White Alpin AntiBac CeramicPlus, RW = Stone White CeramicPlus, S5 = Ebony CeramicPlus, i4 = Graphite CeramicPlus

SUBWAY 2.0





€ excl. VAT

Registered design

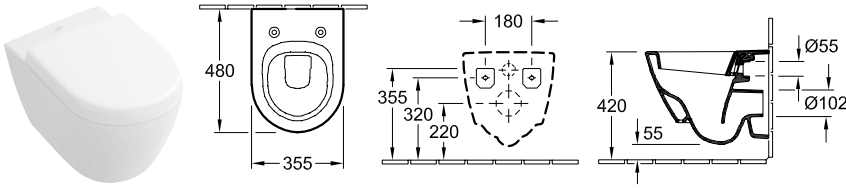
Please order tap fittings and soap dispenser separately

COMPACT WASHDOWN TOILET





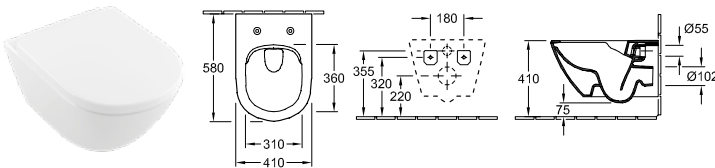

Article number	Description	01	plus R1	plus T2		pcs/ pal.	kg/ pc.
5606 10 XX	355 x 480 mm  					12	23,45
wall-mounted, horizontal outlet, incl. fastening set "SupraFix compact", with water-saving AQUAREDUCT® system: flush volume 3 / 4,5 litres							
9M69 S1 XX	TOILET SEAT AND COVER COMPACT with QuickRelease and SoftClosing hinges, hinges in stainless steel		-	-	-	90	2,88
9M69 Q1 XX	TOILET SEAT AND COVER COMPACT with QuickRelease hinges, hinges in stainless steel		-	-	-	90	2,88
9222 87 00	VIPROTECT SOUNDPROOFING SET (optional) incl. accessories	-	-	-	-	600	0,086
9224 27 00	TOILET INSTALLATION SYSTEM for dry-wall construction, standard height 525 x 1120 x 135 mm For further ViConnect models, see pages 368-379 	-	-	-	-	10	15,8
9224 65 00	TOILET INSTALLATION SYSTEM for dry-wall construction, low 450 x 1120 x 165 mm For further ViConnect models, see pages 368-379 	-	-	-	-	8	19,78

WASHDOWN TOILET COMFORT, RIMLESS

DirectFlush



Article number	Description	01	plus R1	plus T2		pcs/ pal.	kg/ pc.
4609 R0 XX	410 x 580 mm   					12	27
wall-mounted, horizontal outlet, incl. fastening set "SupraFix compact", with water-saving AQUAREDUCT® system: flush volume 3 / 4,5 litres, not suitable for installation with flush valves							
9M86 S1 XX	TOILET SEAT AND COVER with QuickRelease and SoftClosing hinges, hinges in stainless steel		-	-	-	60	3,5
8M34 S1 01	TOILET SEAT AND COVER COMFORT with ergonomic seat ring, with QuickRelease and SoftClosing hinges, hinges in stainless steel		-	-	-	60	3,65
9222 87 00	VIPROTECT SOUNDPROOFING SET (optional) incl. accessories	-	-	-	-	600	0,086
9224 65 00	TOILET INSTALLATION SYSTEM for dry-wall construction, low 450 x 1120 x 165 mm For further ViConnect models, see pages 368-379 	-	-	-	-	8	19,78
9224 27 00	TOILET INSTALLATION SYSTEM for dry-wall construction, standard height 525 x 1120 x 135 mm For further ViConnect models, see pages 368-379 	-	-	-	-	10	15,8

XX = Colour code to be indicated

01 = White Alpin, R1 = White Alpin CeramicPlus, R3 = Pergamon CeramicPlus, T2 = White Alpin AntiBac CeramicPlus, RW = Stone White CeramicPlus, S5 = Ebony CeramicPlus, i4 = Graphite CeramicPlus

SUBWAY 2.0

€ excl. VAT

Registered design

Please order tap fittings and soap dispenser separately



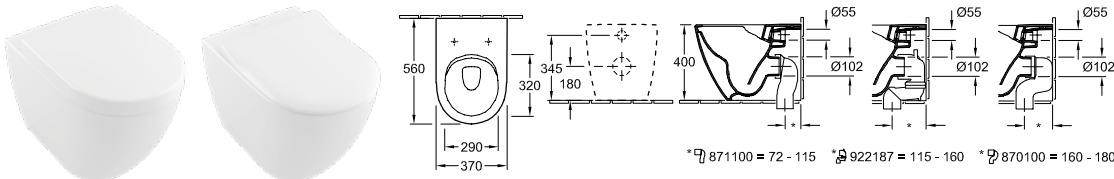

WASHDOWN TOILET, RIMLESS

DirectFlush



Article number	Description	01	plus R1	plus T2			pcs/ pal.	kg/ pc.
5602 R0 XX	370 x 560 mm 			-	-	-	8	29,1

floor-standing, back to wall, horizontal outlet, with fastening set for concealed fastening, with water-saving AQUAREDUCT® system: flush volume 3 / 4,5 litres, not suitable for installation with flush valves

9M78 S1 XX	TOILET SEAT AND COVER SLIMSEAT with QuickRelease and SoftClosing hinges, hinges in stainless steel 		-	-	-	-	90	2,968
9M68 S1 XX	TOILET SEAT AND COVER with QuickRelease and SoftClosing hinges, hinges in stainless steel		-	-	-	-	90	3,647
9M68 Q1 XX	TOILET SEAT AND COVER with QuickRelease hinges, hinges in stainless steel		-	-	-	-	90	3,647
9M74 61 01	SEAT hinges in stainless steel		-	-	-	-	90	1,35
8711 00 00	VARIO DRAINBEND for vertical outlet for installation close to the wall 72 - 115 mm 	-	-	-	-	-		0,72
9221 87 00	VARIO DRAINBEND for vertical outlet for installation close to the wall 115 - 160 mm 	-	-	-	-	-		1,95
8701 00 00	VARIO DRAINBEND for vertical outlet for installation close to the wall 160 - 180 mm 	-	-	-	-	-		0,74

XX = Colour code to be indicated

01 = White Alpin, R1 = White Alpin CeramicPlus, R3 = Pergamon CeramicPlus, T2 = White Alpin AntiBac CeramicPlus, RW = Stone White CeramicPlus, S5 = Ebony CeramicPlus, i4 = Graphite CeramicPlus

SUBWAY 2.0

€ excl. VAT

Registered design

Please order tap fittings and soap dispenser separately

WASHDOWN TOILET FOR CLOSE-COUPLED WC-SUITE, RIMLESS

DirectFlush

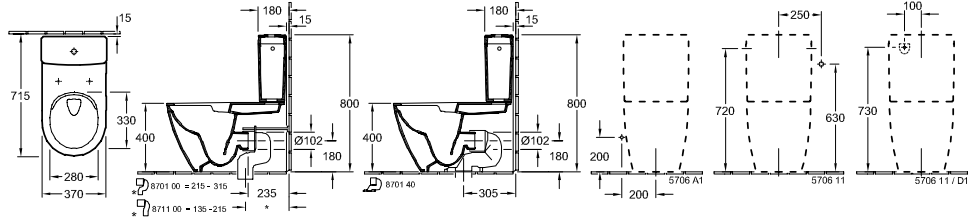

Article number	Description		01	plus R1	plus T2		pcs/ pal.	kg/ pc.
5617 R0 XX	370 x 700 mm	Direct Flush					6	37,76
floor-standing, back to wall, horizontal outlet, with fastening set for concealed fastening, recommendation: to be installed from the wall at: 15 mm								
5706 11 XX	CISTERN water inlet from the sides or rear, flushing mechanism with DualFlush water-saving button, chrome						20	17,1
9M68 S1 XX	TOILET SEAT AND COVER with QuickRelease and SoftClosing hinges, hinges in stainless steel						90	3,647
9M68 Q1 XX	TOILET SEAT AND COVER with QuickRelease hinges, hinges in stainless steel						90	3,647
9M78 S1 XX	TOILET SEAT AND COVER SLIMSEAT with QuickRelease and SoftClosing hinges, hinges in stainless steel	Slim Seat					90	2,968
9M74 61 01	SEAT hinges in stainless steel						90	1,35
8701 00 00	VARIO DRAINBEND for vertical outlet 215 - 315 mm	?						0,74
8711 00 00	VARIO DRAINBEND for vertical outlet 135 - 215 mm	?						0,72

TOILET SEAT AND COVER



Article number	Description		01	RW, S5, i4			pcs/ pal.	kg/ pc.
8M42 S1 XX	with QuickRelease and SoftClosing hinges, hinges in stainless steel	NEW						2,63

TOILET SEAT AND COVER



Article number	Description		01				pcs/ pal.	kg/ pc.
9M68 Q1 XX	with QuickRelease hinges, hinges in stainless steel						90	3,647
9M68 S1 XX	with QuickRelease and SoftClosing hinges, hinges in stainless steel						90	3,647

TOILET SEAT AND COVER SLIMSEAT



Article number	Description		01				pcs/ pal.	kg/ pc.
9M78 S1 XX	with QuickRelease and SoftClosing hinges, hinges in stainless steel	Slim Seat					90	2,968

XX = Colour code to be indicated

01 = White Alpin, R1 = White Alpin CeramicPlus, R3 = Pergamon CeramicPlus, T2 = White Alpin AntiBac CeramicPlus, RW = Stone White CeramicPlus, S5 = Ebony CeramicPlus, i4 = Graphite CeramicPlus

SUBWAY 2.0

€ excl. VAT







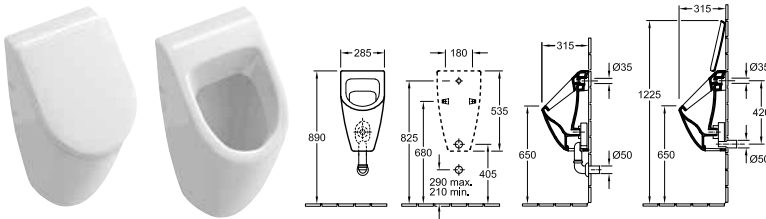

Registered design

Please order tap fittings and soap dispenser separately

SIPHONIC URINAL

We recommend the urinal from SUBWAY for use with SUBWAY 2.0



Article number	Description	01	plus R1	plus T2	plus RW		pcs/ pal.	kg/ pc.
7513 01 XX	285 x 535 x 315 mm for cover					-	15	16,82
7513 00 XX	285 x 535 x 315 mm without cover					-	15	16,82
with fastening set for concealed fastening, concealed water inlet, Outlet may be concealed depending on the type of extractor section								
9956 S1 XX	COVER with SoftClosing hinges, chrome hinges		-	-	-	-	90	2
9326 00 00	EXTRACTOR (optional) horizontal outlet, Flush volume: 1,0 l		-	-	-	-		0,164
9327 00 00	EXTRACTOR (optional) vertical outlet, Flush volume: 1,0 l		-	-	-	-		0,175
9319 00 00	CONNECTION PIECES (optional) comprising: collar, outlet elbow, drain pipe 150 mm long		-	-	-	-		0,232
9933 00 00	WATER-INLET CONNECTOR (optional)		-	-	-	-		0,2
9190 B1 00	PRODETECT 2 RADAR FLUSH CONTROL FOR URINALS (optional) electronic urinal flushing system, battery-operated (6 x 1.5 V AAA required), pipe thread inlet connector 1/2"		-	-	-	-		0,974
9190 N1 00	PRODETECT 2 RADAR FLUSH CONTROL FOR URINALS (optional) electronic urinal flushing system, mains-powered (110 - 240 V), Bluetooth-compatible thanks to optional adapter, pipe thread inlet connector 1/2"		-	-	-	-		1,006
9190 61 00	BLUETOOTH ADAPTER (optional) Bluetooth-adapter for 9190 N1 for wireless function change and maintenance, incl. free app for iOS and Android, suitable for smartphones and tablets		-	-	-	-		0,03
9190 57 00	ADAPTER FOR MAINS POWER SUPPLY CONNECTION (optional) recommendation: to install with power supply unit 9190 N1 00		-	-	-	-		0,038
9221 85 00	URINAL INSTALLATION SYSTEM FOR PRODETECT 525 x 1120 x 80 mm For further ViConnect models, see pages 368-379		-	-	-	-	10	7,15
9219 89 00	URINAL INSTALLATION SYSTEM 525 x 1120 x 98 mm For further ViConnect models, see pages 368-379		-	-	-	-		8,05

SUBWAY 2.0

XX = Colour code to be indicated

01 = White Alpin, R1 = White Alpin CeramicPlus, R3 = Pergamon CeramicPlus, T2 = White Alpin AntiBac CeramicPlus, RW = Stone White CeramicPlus, S5 = Ebony CeramicPlus, i4 = Graphite CeramicPlus

SUBWAY 2.0

€ excl. VAT

Registered design

Produced to order (Please note that it is not always possible to cancel or change orders!), The washbasins are to be ordered separately.

Express Delivery These products are always available from stock in the colours: **Glossy White (DH), Glossy Grey (FP)**

Front:

laminated MDF in DH, E8, FP, PN (19 mm)
 painted MDF in PD (19 mm)
 direct-laminated chipboard in MS, VG, VH, VJ, VK (19 mm)
 horizontal grain in E8, PN, VH, VJ
 matching interior colour for DH, FP
 interior colour to match décor for E8, MS, VG, VH, VJ, VK
 interior colour Anthracite for PD

Body:

laminated MDF in DH, FP (19 mm)
 painted MDF in PD (19 mm)
 direct-laminated chipboard in E8, MS, PN, VG, VH, VJ, VK (19 mm)
 horizontal grain for vanity unit, sideboard in E8, PN, VH, VJ
 vertical grain for side cabinet, tall cabinet in E8, PN, VH, VJ
 matching interior colour for DH, FP

interior colour to match décor for E8, MS, VG, VH, VJ, VK

interior colour Anthracite for PD

Top panel:

Optiwhite glass painted on rear in Glass Silver Grey (R) or Glass White (S) (10 mm)

Drawers:

SoftClosing feature

Doors:

SoftClosing feature

Handles:

handles integrated in the front, matt silver-coloured or glossy chrome-coloured

Interior compartments :

adjustable glass partitions (8 mm)

accessory boxes made of grey translucent plastic

Shelves:

anodised aluminium

Please note:

For further information such as tap fitting positions, installation and fastening dimensions etc. please see the technical drawings.

	ACCESSORIES PACKAGE 2			
Equipped with	6x narrow glass drawer divider 1x accessory box S 1x accessory box M 1x accessory box L			
	VANITY UNIT	VANITY UNIT	VANITY UNIT	VANITY UNIT
Article number	A692 Y0 XX	A699 Y0 XX	A917 Y0 XX	A691 Y0 XX
Dimensions (w x h x d)	1287 x 420 x 449 mm	1287 x 520 x 449 mm	1287 x 590 x 449 mm	1287 x 420 x 449 mm
Version	washbasin on the middle	washbasin on the middle	washbasin on the middle	washbasin on the middle
For combination with	Subway 2.0 7175 D0	Subway 2.0 7175 D0	Subway 2.0 7175 D0	Subway 2.0 7176 D0/D2
Equipped with	1x Accessories package 2 4x pull-out compartment	1x Accessories package 2 4x pull-out compartment	1x Accessories package 2 4x pull-out compartment	1x Accessories package 2 4x pull-out compartment
Installation	wall-mounted	wall-mounted	wall-mounted	wall-mounted
Scope of delivery	fastening set included	fastening set included	fastening set included	fastening set included
DH, E8, FP, MS, PN, VG, VH, VJ, VK				
PD				

SUBWAY 2.0

XX = Insert front and body colour
 DH = Glossy White, FP = Glossy Grey, MS = White Matt, PD = Black Matt Lacquer, VG = Truffle Grey, VK = Soft Grey, E8 = White Wood, PN = Elm Impreso, VH = Arizona Oak, VJ = Nordic Oak

Y = Handle code to be indicated
 0 = matt silver-coloured, 1 = glossy chrome-coloured

Z = Insert colour code for cover panels
 R = Glass Silver Grey, S = Glass White

SUBWAY 2.0

€ excl. VAT

Registered design

Produced to order (Please note that it is not always possible to cancel or change orders!), The washbasins are to be ordered separately.

Express Delivery These products are always available from stock in the colours: **Glossy White (DH), Glossy Grey (FP)**

	VANITY UNIT	VANITY UNIT	VANITY UNIT	VANITY UNIT
Article number	A698 Y0 XX	A916 Y0 XX	A690 Y0 XX	A697 Y0 XX
Dimensions (w x h x d)	1287 x 520 x 449 mm	1287 x 590 x 449 mm	987 x 420 x 449 mm	987 x 520 x 449 mm
Versión	washbasin on the middle	washbasin on the middle	washbasin on the middle	washbasin on the middle
For combination with	Subway 2.0 7176 D0/D2	Subway 2.0 7176 D0/D2	Subway 2.0 7175 A0	Subway 2.0 7175 A0
Equipped with	1x Accessories package 2 4x pull-out compartment	1x Accessories package 2 4x pull-out compartment	1x Accessories package 2 2x pull-out compartment	1x Accessories package 2 2x pull-out compartment
Installation	wall-mounted	wall-mounted	wall-mounted	wall-mounted
Scope of delivery	fastening set included	fastening set included	fastening set included	fastening set included
DH, E8, FP, MS, PN, VG, VH, VJ, VK				
PD				
	VANITY UNIT	VANITY UNIT	VANITY UNIT	VANITY UNIT
Article number	A915 Y0 XX	A689 Y0 XX	A696 Y0 XX	A914 Y0 XX
Dimensions (w x h x d)	987 x 590 x 449 mm	787 x 420 x 449 mm	787 x 520 x 449 mm	787 x 590 x 449 mm
Versión	washbasin on the middle	washbasin on the middle	washbasin on the middle	washbasin on the middle
For combination with	Subway 2.0 7175 A0	Subway 2.0 7175 80	Subway 2.0 7175 80	Subway 2.0 7175 80
Equipped with	1x Accessories package 2 2x pull-out compartment	1x Accessories package 2 2x pull-out compartment	1x Accessories package 2 2x pull-out compartment	1x Accessories package 2 2x pull-out compartment
Installation	wall-mounted	wall-mounted	wall-mounted	wall-mounted
Scope of delivery	fastening set included	fastening set included	fastening set included	fastening set included
DH, E8, FP, MS, PN, VG, VH, VJ, VK				
PD				

SUBWAY 2.0

XX = Insert front and body colour
 DH = Glossy White, FP = Glossy Grey, MS = White Matt, PD = Black Matt Lacquer, VG = Truffle Grey, VK = Soft Grey, E8 = White Wood, PN = Elm Impreso, VH = Arizona Oak, VJ = Nordic Oak

Y = Handle code to be indicated
 0 = matt silver-coloured, 1 = glossy chrome-coloured

Z = Insert colour code for cover panels
 R = Glass Silver Grey, S = Glass White

SUBWAY 2.0

€ excl. VAT

Registered design

Produced to order (Please note that it is not always possible to cancel or change orders!), The washbasins are to be ordered separately.

Express Delivery These products are always available from stock in the colours: **Glossy White (DH), Glossy Grey (FP)**

	VANITY UNIT	VANITY UNIT	VANITY UNIT	VANITY UNIT
Article number	A688 Y0 XX	A910 Y0 XX	A687 Y0 XX	A909 Y0 XX
Dimensions (w x h x d)	637 x 420 x 454 mm	637 x 590 x 454 mm	587 x 420 x 454 mm	587 x 590 x 454 mm
Version	washbasin on the middle	washbasin on the middle	washbasin on the middle	washbasin on the middle
For combination with	Subway 2.0 7113 FA	Subway 2.0 7113 FA	Subway 2.0 7113 F0	Subway 2.0 7113 F0
Equipped with	1x accessory box L 1x pull-out compartment	1x accessory box L 2x pull-out compartment	1x accessory box L 1x pull-out compartment	1x accessory box L 2x pull-out compartment
Installation	wall-mounted	wall-mounted	wall-mounted	wall-mounted
Scope of delivery	fastening set included	fastening set included	fastening set included	fastening set included
DH, E8, FP, MS, PN, VG, VH, VJ, VK				
PD				
	VANITY UNIT	VANITY UNIT	VANITY UNIT	VANITY UNIT
Article number	A686 Y0 XX	A908 Y0 XX	A685 Y0 XX	A907 Y0 XX
Dimensions (w x h x d)	537 x 420 x 423 mm	537 x 590 x 423 mm	485 x 420 x 379 mm	485 x 590 x 379 mm
Version	washbasin on the middle	washbasin on the middle	washbasin on the middle	washbasin on the middle
For combination with	Subway 2.0 7113 F5	Subway 2.0 7113 F5	Subway 2.0 7315 F0	Subway 2.0 7315 F0
Equipped with	1x accessory box L 1x pull-out compartment	1x accessory box L 2x pull-out compartment	1x accessory box L 1x pull-out compartment	1x accessory box L 2x pull-out compartment
Installation	wall-mounted	wall-mounted	wall-mounted	wall-mounted
Scope of delivery	fastening set included	fastening set included	fastening set included	fastening set included
DH, E8, FP, MS, PN, VG, VH, VJ, VK				
PD				

SUBWAY 2.0

XX = Insert front and body colour
 DH = Glossy White, FP = Glossy Grey, MS = White Matt, PD = Black Matt
 Lacquer, VG = Truffle Grey, VK = Soft Grey, E8 = White Wood, PN = Elm
 Impresso, VH = Arizona Oak, VJ = Nordic Oak

Y = Handle code to be indicated
 0 = matt silver-coloured, 1 = glossy chrome-coloured

Z = Insert colour code for cover panels
 R = Glass Silver Grey, S = Glass White

SUBWAY 2.0

€ excl. VAT

Registered design

Produced to order (Please note that it is not always possible to cancel or change orders!), The washbasins are to be ordered separately.

Express Delivery These products are always available from stock in the colours: **Glossy White (DH), Glossy Grey (FP)**

	VANITY UNIT	VANITY UNIT
Article number	A684 Y0 XX	A906 Y0 XX
Dimensions (w x h x d)	440 x 420 x 352 mm	440 x 590 x 351 mm
Version	washbasin on the middle	washbasin on the middle
For combination with	Subway 2.0 7315 F5	Subway 2.0 7315 F5
Equipped with	1x accessory box L 1x pull-out compartment	1x accessory box L 2x pull-out compartment
Installation	wall-mounted	wall-mounted
Scope of delivery	fastening set included	fastening set included
DH, E8, FP, MS, PN, VG, VH, VJ, VK		
PD		

	TALL CABINET	TALL CABINET	TALL CABINET	TALL CABINET
Article number	A709 Y0 XX	A710 Y0 XX	A707 Y0 XX	A708 Y0 XX
Dimensions (w x h x d)	350 x 1650 x 370 mm	350 x 1650 x 370 mm	350 x 1650 x 370 mm	350 x 1650 x 370 mm
Hinges	hinges on left	hinges on right	hinges on left	hinges on right
Equipped with	2x door 3x shelf	2x door 3x shelf	2x door 1x drawer 3x shelf	2x door 1x drawer 3x shelf
Installation	wall-mounted	wall-mounted	wall-mounted	wall-mounted
Scope of delivery	fastening set included	fastening set included	fastening set included	fastening set included
DH, E8, FP, MS, PN, VG, VH, VJ, VK				
PD				

SUBWAY 2.0

XX = Insert front and body colour
 DH = Glossy White, FP = Glossy Grey, MS = White Matt, PD = Black Matt
 Lacquer, VG = Truffle Grey, VK = Soft Grey, E8 = White Wood, PN = Elm
 Impreso, VH = Arizona Oak, VJ = Nordic Oak

Y = Handle code to be indicated
 0 = matt silver-coloured, 1 = glossy chrome-coloured

Z = Insert colour code for cover panels
 R = Glass Silver Grey, S = Glass White



SUBWAY 2.0

€ excl. VAT

Registered design

Produced to order (Please note that it is not always possible to cancel or change orders!), The washbasins are to be ordered separately.

Express Delivery These products are always available from stock in the colours: **Glossy White (DH), Glossy Grey (FP)**

	SIDE CABINET	SIDE CABINET	SIDE CABINET	SIDE CABINET
				
Article number	A714 YZ XX	A715 YZ XX	A712 YZ XX	A713 YZ XX
Dimensions (w x h x d)	356 x 857 x 370 mm	356 x 857 x 370 mm	356 x 857 x 370 mm	356 x 857 x 370 mm
Hinges	hinges on left	hinges on right	hinges on left	hinges on right
Equipped with	1x pull-out compartment 1x door 1x shelf	1x pull-out compartment 1x door 1x shelf	2x drawer 1x door 1x shelf	2x drawer 1x door 1x shelf
Installation	wall-mounted	wall-mounted	wall-mounted	wall-mounted
Scope of delivery	fastening set included	fastening set included	fastening set included	fastening set included
DH, E8, FP, MS, PN, VG, VH, VJ, VK				
PD				

SHELF

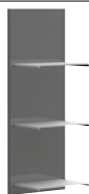

Express Delivery

Article number	A705 00 XX
Dimensions (w x h x d)	280 x 750 x 195 mm
Equipped with	3x shelf, anodised aluminium
Installation	wall-mounted
Scope of delivery	fastening set included
DH, E8, FP, MS, PN, VG, VH, VJ, VK	
PD	

SIDEBOARD



Article number	A704 YZ XX
Dimensions (w x h x d)	758 x 399 x 235 mm
Equipped with	2x door 1x shelf
Installation	wall-mounted
Scope of delivery	fastening set included
DH, E8, FP, MS, PN, VG, VH, VJ, VK	
PD	

XX = Insert front and body colour

DH = Glossy White, FP = Glossy Grey, MS = White Matt, PD = Black Matt Lacquer, VG = Truffle Grey, VK = Soft Grey, E8 = White Wood, PN = Elm Impresso, VH = Arizona Oak, VJ = Nordic Oak

Y = Handle code to be indicated

0 = matt silver-coloured, 1 = glossy chrome-coloured

Z = Insert colour code for cover panels

R = Glass Silver Grey, S = Glass White

SUBWAY

Bath ceramic

- Mainstream segment
- Match washbasins in the collection Subway 2.0

PRO.VILLEROY-BOCH.COM/TECHNICALDRAWINGS



SUBWAY

Ceramic colours



01 = White Alpin



R1 = White Alpin
CeramicPlus

SUBWAY





€ excl. VAT

Registered design

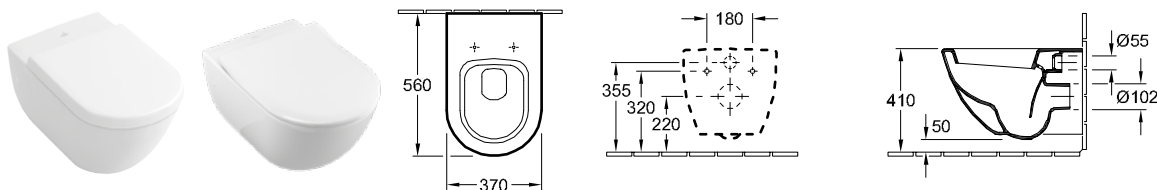
Please order tap fittings and soap dispenser separately



WASHDOWN TOILET

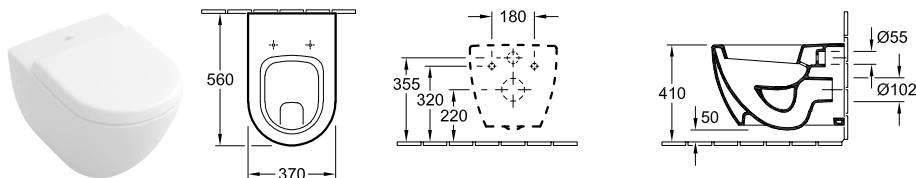

Article number	Description	01	plus R1	pcs/ pal.	kg/ pc.
6600 10 XX	370 x 560 mm			12	27,5
wall-mounted, horizontal outlet, with fastening set for concealed fastening					
9M55 S1 XX	TOILET SEAT AND COVER with QuickRelease and SoftClosing hinges, hinges in stainless steel		-	90	3,59
9M55 Q1 XX	TOILET SEAT AND COVER with QuickRelease hinges, hinges in stainless steel		-	90	3,647
9M55 61 01	TOILET SEAT AND COVER hinges in stainless steel		-	90	2,57
9M65 S1 XX	TOILET SEAT AND COVER SLIMSEAT with QuickRelease and SoftClosing hinges, hinges in stainless steel		-	90	2,971
9M65 61 01	TOILET SEAT AND COVER SLIMSEAT hinges in stainless steel		-	90	2,971
9M63 61 01	SEAT with continuous hinge bolt, hinges in stainless steel		-	90	1,68
9222 87 00	VIPROTECT SOUNDPROOFING SET (optional) incl. accessories		-	600	0,086
9224 27 00	TOILET INSTALLATION SYSTEM for dry-wall construction, standard height 525 x 1120 x 135 mm For further ViConnect models, see pages 368-379		-	10	15,8
9224 65 00	TOILET INSTALLATION SYSTEM for dry-wall construction, low 450 x 1120 x 165 mm For further ViConnect models, see pages 368-379		-	8	19,78

WASHOUT TOILET



Article number	Description	01	plus R1	pcs/ pal.	kg/ pc.
6603 10 XX	370 x 560 mm			12	29,3
wall-mounted, horizontal outlet, with fastening set for concealed fastening					
9M55 S1 XX	TOILET SEAT AND COVER with QuickRelease and SoftClosing hinges, hinges in stainless steel		-	90	3,59
9M55 Q1 XX	TOILET SEAT AND COVER with QuickRelease hinges, hinges in stainless steel		-	90	3,647
9M55 61 01	TOILET SEAT AND COVER hinges in stainless steel		-	90	2,57
9M65 S1 XX	TOILET SEAT AND COVER SLIMSEAT with QuickRelease and SoftClosing hinges, hinges in stainless steel		-	90	2,971
9M65 61 01	TOILET SEAT AND COVER SLIMSEAT hinges in stainless steel		-	90	2,971
9M63 61 01	SEAT with continuous hinge bolt, hinges in stainless steel		-	90	1,68
9222 87 00	VIPROTECT SOUNDPROOFING SET (optional) incl. accessories		-	600	0,086
9224 27 00	TOILET INSTALLATION SYSTEM for dry-wall construction, standard height 525 x 1120 x 135 mm For further ViConnect models, see pages 368-379		-	10	15,8

XX = Colour code to be indicated

01 = White Alpin, R1 = White Alpin CeramicPlus

SUBWAY

€ excl. VAT

Registered design

Please order tap fittings and soap dispenser separately

WASHDOWN TOILET FOR CLOSE-COUPLED WC-SUITE

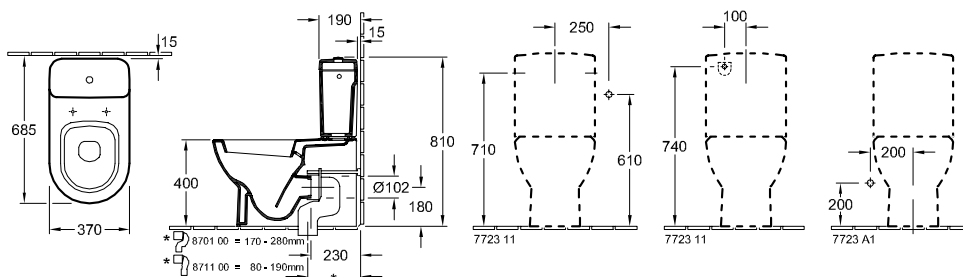

Article number	Description	01	plus R1	pcs/ pal.	kg/ pc.
6610 10 XX	370 x 670 mm			-	6 36,5
floor-standing, back to wall, horizontal outlet, with fastening set for concealed fastening, recommendation: to be installed from the wall at: 15 mm					
7723 11 XX	CISTERN water inlet from the sides or rear, flushing mechanism with DualFlush water-saving button, chrome			-	32 15,42
9M55 S1 XX	TOILET SEAT AND COVER with QuickRelease and SoftClosing hinges, hinges in stainless steel			-	90 3,59
9M55 Q1 XX	TOILET SEAT AND COVER with QuickRelease hinges, hinges in stainless steel			-	90 3,647
9M55 61 01	TOILET SEAT AND COVER hinges in stainless steel			-	90 2,57
9M65 S1 XX	TOILET SEAT AND COVER SLIMSEAT with QuickRelease and SoftClosing hinges, hinges in stainless steel			-	90 2,971
9M65 61 01	TOILET SEAT AND COVER SLIMSEAT hinges in stainless steel			-	90 2,971
9M63 61 01	SEAT with continuous hinge bolt, hinges in stainless steel			-	90 1,68
8701 00 00	VARIO DRAINBEND for vertical outlet 180 - 280 mm			-	0,74
8711 00 00	VARIO DRAINBEND for vertical outlet 80 - 190 mm			-	0,72

TOILET SEAT AND COVER SLIMSEAT



Article number	Description	01			pcs/ pal.	kg/ pc.
9M65 S1 XX	with QuickRelease and SoftClosing hinges, hinges in stainless steel			-	90	2,971

TOILET SEAT AND COVER COMPACT



Article number	Description	01			pcs/ pal.	kg/ pc.
9M66 61 01	hinges in stainless steel			-	90	2,882

XX = Colour code to be indicated
01 = White Alpin, R1 = White Alpin CeramicPlus

SUBWAY

€ excl. VAT

Registered design

Please order tap fittings and soap dispenser separately

SIPHONIC URINAL

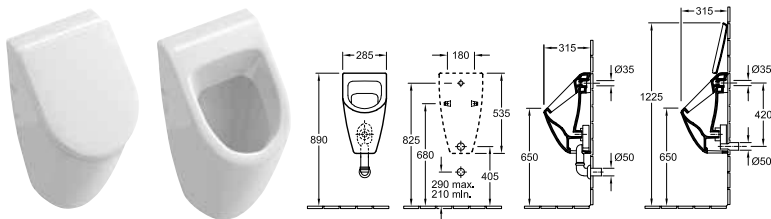

Article number	Description	01	plus R1		pcs/ pal.	kg/ pc.
7513 01 XX	285 x 535 x 315 mm for cover			-	15	16,82
7513 00 XX	285 x 535 x 315 mm without cover			-	15	16,82
with fastening set for concealed fastening, concealed water inlet, Outlet may be concealed depending on the type of extractor section						
9956 S1 XX	COVER with SoftClosing hinges, chrome hinges			-	90	2
9326 00 00	EXTRACTOR (optional) horizontal outlet, Flush volume: 1,0 l			-		0,164
9327 00 00	EXTRACTOR (optional) vertical outlet, Flush volume: 1,0 l			-		0,175
9319 00 00	CONNECTION PIECES (optional) comprising: collar, outlet elbow, drain pipe 150 mm long			-		0,232
9933 00 00	WATER-INLET CONNECTOR (optional)			-		0,2
9190 B1 00	PRODETECT 2 RADAR FLUSH CONTROL FOR URINALS (optional) electronic urinal flushing system, battery-operated (6 x 1.5 V AAA required), pipe thread inlet connector 1/2"			-		0,974
9190 N1 00	PRODETECT 2 RADAR FLUSH CONTROL FOR URINALS (optional) electronic urinal flushing system, mains-powered (110 - 240 V), Bluetooth-compatible thanks to optional adapter, pipe thread inlet connector 1/2"			-		1,006
9190 61 00	BLUETOOTH ADAPTER (optional) Bluetooth-adapter for 9190 N1 for wireless function change and maintenance, incl. free app for iOS and Android, suitable for smartphones and tablets			-		0,03
9190 57 00	ADAPTER FOR MAINS POWER SUPPLY CONNECTION (optional) recommendation: to install with power supply unit 9190 N1 00			-		0,038
9221 85 00	URINAL INSTALLATION SYSTEM FOR PRODETECT 525 x 1120 x 80 mm For further ViConnect models, see pages 368-379			-	10	7,15
9219 89 00	URINAL INSTALLATION SYSTEM 525 x 1120 x 98 mm For further ViConnect models, see pages 368-379			-		8,05

XX = Colour code to be indicated
01 = White Alpin, R1 = White Alpin CeramicPlus

VENTICELLO

Sanitaryware and Bathroom Furniture

PRO.VILLEROY-BOCH.COM/TECHNICALDRAWINGS

- Mainstream segment
- Matching furniture programme Venticello
- Designed to match all mirror collections
- Designed to match all mirror cabinet collections



Ceramic colours



Front- / Body colours



Front colours



VENTICELLO





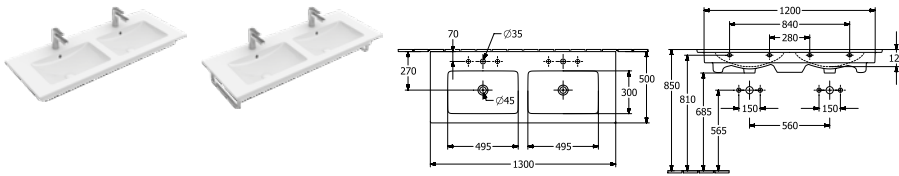

VENTICELLO

€ excl. VAT

Please order tap fittings and soap dispenser separately







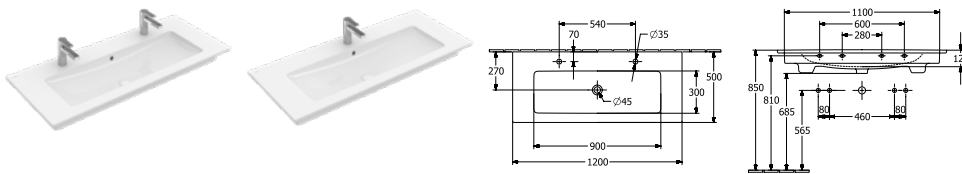

DOUBLE VANITY WASHBASIN



Article number	Description	01	plus R1	plus RW		pcs/ pal.	kg/ pc.
4111 DL XX	1300 x 500 mm 2x    				-	8	38,2
4111 DJ XX	1300 x 500 mm   when using a wall-mounted tap fitting, we recommend a projection of at least 210 mm				-	8	38,2
wall fixation, towel holder (not included in scope of delivery): side installation (mountable: 2 pc.), matching furniture programme: Venticello For further information about matching valves and CAP, see pages 380-383							
9296 40 D7	TOWEL RAIL (optional) stainless steel, fastening set included	-	-	-			0,84
9221 49 00	WASHBASIN INSTALLATION ELEMENT  525 x 1120 x 75 mm For further ViConnect models, see pages 368-379	-	-	-		10	8,05

VANITY WASHBASIN



Article number	Description	01	plus R1	plus RW		pcs/ pal.	kg/ pc.
4104 CK XX	1200 x 500 mm 2x   with 2 single-lever mixers and turn-knob operation or in conjunction with toggle valve, as well as push-open valve, please do not exceed a flow rate of max. 7.5 l/min per tap fitting.				-	8	32,5
4104 CL XX	1200 x 500 mm    				-	8	32,5
4104 CJ XX	1200 x 500 mm   when using a wall-mounted tap fitting, we recommend a projection of at least 210 mm				-	8	32,5
wall fixation, towel holder (not included in scope of delivery): side installation (mountable: 2 pc.), matching furniture programme: Venticello For further information about matching valves and CAP, see pages 380-383							
9296 40 D7	TOWEL RAIL (optional) stainless steel, fastening set included	-	-	-			0,84
9221 49 00	WASHBASIN INSTALLATION ELEMENT  525 x 1120 x 75 mm For further ViConnect models, see pages 368-379	-	-	-		10	8,05

VENTICELLO

€ excl. VAT

Please order tap fittings and soap dispenser separately

VANITY WASHBASIN

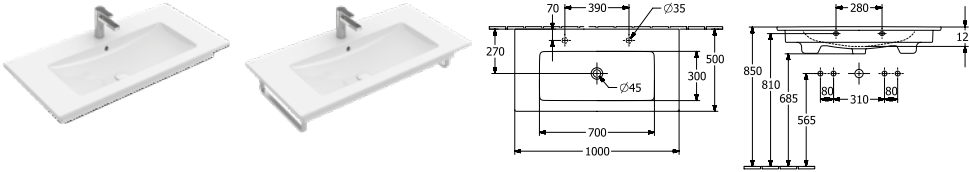

Article number	Description	01	plus R1	plus RW		pcs/ pal.	kg/ pc.
4104 AK XX	1000 x 500 mm 2xØ with 2 single-lever mixers and turn-knob operation or in conjunction with toggle valve, as well as push-open valve, please do not exceed a flow rate of max. 7.5 l/min per tap fitting.				-	8	28,05
4104 AL XX	1000 x 500 mm				-	8	28,05
4104 AJ XX	1000 x 500 mm when using a wall-mounted tap fitting, we recommend a projection of at least 210 mm				-	8	28,05

wall fixation, towel holder (not included in scope of delivery): side installation (mountable: 2 pc.), matching furniture programme: Venticello
For further information about matching valves and CAP, see pages 380-383

9296 40 D7	TOWEL RAIL (optional) stainless steel, fastening set included	-	-	-			0,84
9221 49 00	WASHBASIN INSTALLATION ELEMENT 525 x 1120 x 75 mm For further ViConnect models, see pages 368-379					10	8,05

VANITY WASHBASIN

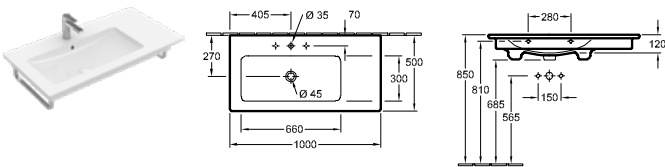

Article number	Description	01	plus R1	plus RW		pcs/ pal.	kg/ pc.
4134 L1 XX	1000 x 500 mm				-	8	28,05
4134 L3 XX	1000 x 500 mm when using a wall-mounted tap fitting, we recommend a projection of at least 210 mm				-	8	28,05

basin left, wall fixation, towel holder (not included in scope of delivery): side installation (mountable: 2 pc.), matching furniture programme: Venticello
For further information about matching valves and CAP, see pages 380-383

9296 40 D7	TOWEL RAIL (optional) stainless steel, fastening set included	-	-	-			0,84
9221 49 00	WASHBASIN INSTALLATION ELEMENT 525 x 1120 x 75 mm For further ViConnect models, see pages 368-379					10	8,05

VANITY WASHBASIN

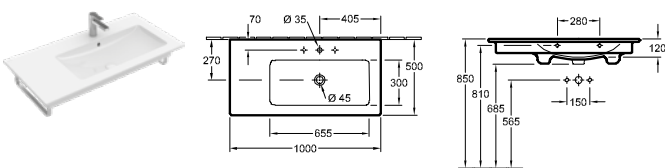

Article number	Description	01	plus R1	plus RW		pcs/ pal.	kg/ pc.
4134 R1 XX	1000 x 500 mm				-	8	28,05
4134 R3 XX	1000 x 500 mm when using a wall-mounted tap fitting, we recommend a projection of at least 210 mm				-	8	28,05

basin right, wall fixation, towel holder (not included in scope of delivery): side installation (mountable: 2 pc.), matching furniture programme: Venticello
For further information about matching valves and CAP, see pages 380-383

9296 40 D7	TOWEL RAIL (optional) stainless steel, fastening set included	-	-	-			0,84
9221 49 00	WASHBASIN INSTALLATION ELEMENT 525 x 1120 x 75 mm For further ViConnect models, see pages 368-379					10	8,05

XX = Colour code to be indicated

01 = White Alpin, R1 = White Alpin CeramicPlus, RW = Stone White CeramicPlus





VENTICELLO

€ excl. VAT

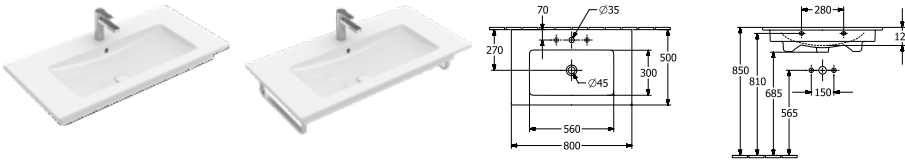
Please order tap fittings and soap dispenser separately

VANITY WASHBASIN







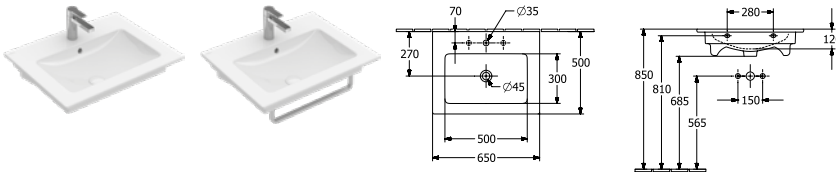

Article number	Description	01	plus R1	plus RW		pcs/ pal.	kg/ pc.
4104 8L XX	800 x 500 mm   				-	12	21,6
4104 8J XX	800 x 500 mm   when using a wall-mounted tap fitting, we recommend a projection of at least 210 mm				-	12	21,6

wall fixation, towel holder (not included in scope of delivery): side installation (mountable: 2 pc.), matching furniture programme: Venticello
For further information about matching valves and CAP, see pages 380-383

9296 40 D7	TOWEL RAIL (optional) stainless steel, fastening set included	-	-	-			0,84
9221 49 00	WASHBASIN INSTALLATION ELEMENT 525 x 1120 x 75 mm For further ViConnect models, see pages 368-379		-	-	-	10	8,05

WASHBASINS







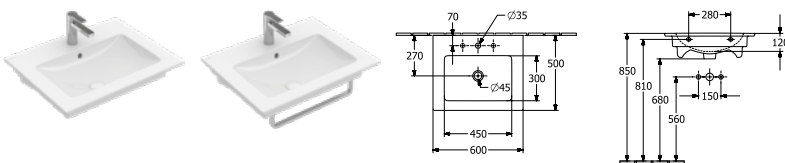

Article number	Description	01	plus R1	plus RW		pcs/ pal.	kg/ pc.
4124 65 XX	650 x 500 mm   				-	14	18,1
4124 67 XX	650 x 500 mm   when using a wall-mounted tap fitting, we recommend a projection of at least 210 mm				-	14	18,1

wall fixation, towel holder (not included in scope of delivery): front installation, matching furniture programme: Venticello
For further information about matching valves and CAP, see pages 380-383

9296 45 D7	TOWEL RAIL (optional) stainless steel, fastening set included	-	-	-			0,92
9221 49 00	WASHBASIN INSTALLATION ELEMENT 525 x 1120 x 75 mm For further ViConnect models, see pages 368-379		-	-	-	10	8,05

WASHBASINS



Article number	Description	01	plus R1	plus RW		pcs/ pal.	kg/ pc.
4124 60 XX	600 x 500 mm   				-	16	17,4
4124 62 XX	600 x 500 mm   when using a wall-mounted tap fitting, we recommend a projection of at least 210 mm				-	16	17,4

wall fixation, towel holder (not included in scope of delivery): front installation, matching furniture programme: Venticello
For further information about matching valves and CAP, see pages 380-383

9296 45 D7	TOWEL RAIL (optional) stainless steel, fastening set included	-	-	-			0,92
9221 49 00	WASHBASIN INSTALLATION ELEMENT 525 x 1120 x 75 mm For further ViConnect models, see pages 368-379		-	-	-	10	8,05

XX = Colour code to be indicated

01 = White Alpin, R1 = White Alpin CeramicPlus, RW = Stone White CeramicPlus

VENTICELLO

€ excl. VAT

Please order tap fittings and soap dispenser separately

WASHBASINS

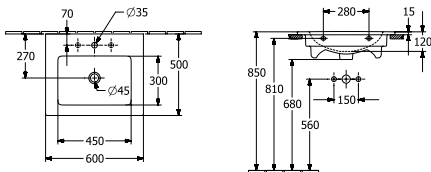

Article number	Description	01	plus R1	plus RW		pcs/ pal.	kg/ pc.
4124 G6 XX	600 x 500 mm				-	10	17,4
ground underside, wall fixation, incl. installation instructions For further information about matching valves and CAP, see pages 380-383							
9221 49 00	WASHBASIN INSTALLATION ELEMENT 525 x 1120 x 75 mm For further ViConnect models, see pages 368-379		-	-	-	10	8,05

SEMI-RECESSED WASHBASIN

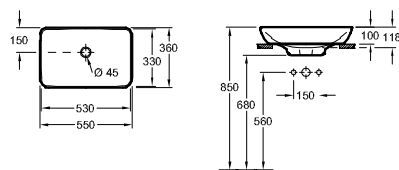

Article number	Description	01	plus R1	plus RW		pcs/ pal.	kg/ pc.
4113 55 XX	550 x 360 mm for wall-mounted washbasin mixers or tall pillar tap fittings, without tap hole area				-	10	10,8
Recommendation: to be installed with a gap of at least 50 mm between the washbasin and the wall, incl. installation instructions, matching furniture programme: Venticello, Legato For further information about matching valves and CAP, see pages 380-383							

HANDWASHBASIN

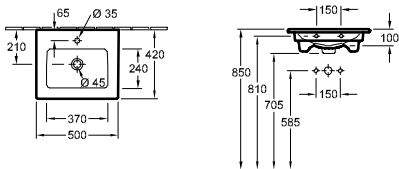

Article number	Description	01	plus R1	plus RW		pcs/ pal.	kg/ pc.
4124 50 XX	500 x 420 mm				-	24	11,5
wall fixation, matching furniture programme: Venticello For further information about matching valves and CAP, see pages 380-383							
9221 49 00	WASHBASIN INSTALLATION ELEMENT 525 x 1120 x 75 mm For further ViConnect models, see pages 368-379		-	-	-	10	8,05

XX = Colour code to be indicated
01 = White Alpin, R1 = White Alpin CeramicPlus, RW = Stone White CeramicPlus

VENTICELLO

€ excl. VAT

Please order tap fittings and soap dispenser separately

BIDET

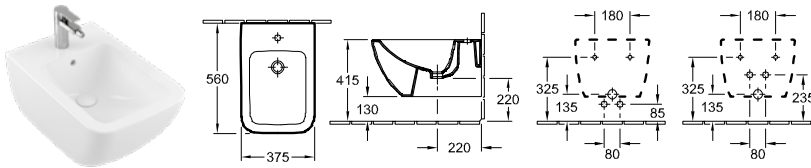

Article number	Description	01	plus R1	plus RW		pcs/ pal.	kg/ pc.
4411 00 XX	375 x 560 mm					12	23,8
wall-mounted, with fastening set for concealed fastening For further information about matching valves, see pages 380-383							
9953 00 00	FASTENING FRAME (optional)	-	-	-			2,93
9221 48 00	BIDET INSTALLATION SYSTEM 525 x 1120 x 100 mm For further ViConnect models, see pages 368-379	-	-	-		10	10,54

WASHDOWN TOILET, RIMLESS

DirectFlush

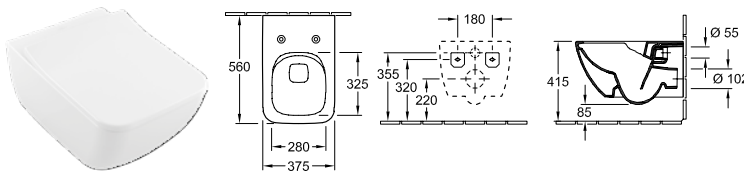

Article number	Description	01	plus R1	plus RW		pcs/ pal.	kg/ pc.
4611 R0 XX	375 x 560 mm					12	27,2
wall-mounted, horizontal outlet, incl. fastening set "SupraFix 3.0", with water-saving AQUAREDUCT® system: flush volume 3 / 4,5 litres, not suitable for installation with flush valves							
9M79 S1 01	TOILET SEAT AND COVER SLIMSEAT (WRAPOVER) with QuickRelease and SoftClosing hinges, hinges in stainless steel		-	-		40	2,65
9M80 S1 01	TOILET SEAT AND COVER SLIMSEAT LINE (SANDWICH) with QuickRelease and SoftClosing hinges, hinges in stainless steel		-	-		40	2,5
8M22 S1 01	TOILET SEAT AND COVER with QuickRelease and SoftClosing hinges, hinges in stainless steel		-	-		108	2,7
9222 87 00	VIPROTECT SOUNDPROOFING SET (optional) incl. accessories	-	-	-		600	0,086
9224 27 00	TOILET INSTALLATION SYSTEM for dry-wall construction, standard height 525 x 1120 x 135 mm For further ViConnect models, see pages 368-379	-	-	-		10	15,8

COMBI-PACK

DirectFlush

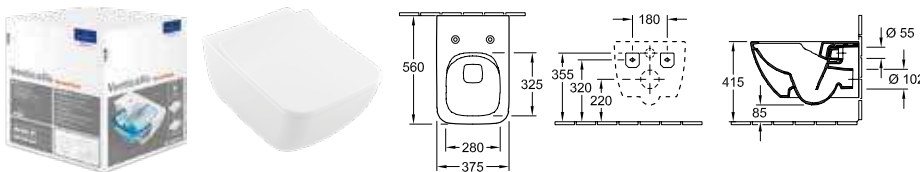

Article number	Description	01	plus R1	plus RW		pcs/ pal.	kg/ pc.
4611 RS XX	individual packaging materials, wall-mounted, horizontal outlet composed of: Washdown WC DirectFlush 4611 R0 XX, SlimSeat with QuickRelease and SoftClosing hinges 9M79 S1 01					12	25,5

XX = Colour code to be indicated

01 = White Alpin, R1 = White Alpin CeramicPlus, RW = Stone White CeramicPlus

VENTICELLO

€ excl. VAT

Please order tap fittings and soap dispenser separately

COMBI-PACK DirectFlush

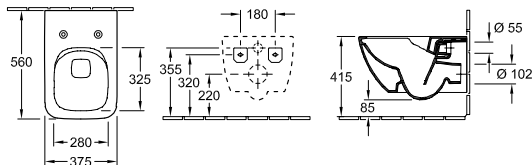

Article number	Description	01	plus R1	plus RW		pcs/ pal.	kg/ pc.
4611 RL XX	individual packaging materials, wall-mounted, horizontal outlet composed of: Washdown WC DirectFlush 4611 R0 XX, SlimSeat Line with QuickRelease and SoftClosing 9M80 S1 XX					12	25,5

WASHDOWN TOILET FOR CLOSE-COUPLED WC-SUITE, RIMLESS DirectFlush

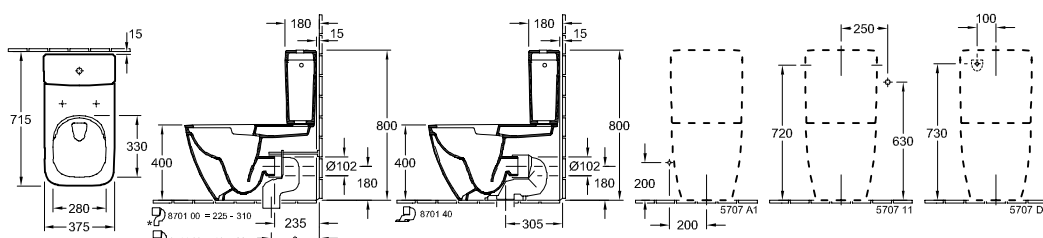

Article number	Description	01	plus R1	plus RW		pcs/ pal.	kg/ pc.
4612 R0 XX	375 x 700 mm					16	40

floor-standing, back to wall, horizontal outlet, with water-saving AQUAREDUCT® system: flush volume 3 / 4,5 litres, recommendation: to be installed from the wall at: 15 mm

5707 11 XX	CISTERN water inlet from the sides or rear, flushing mechanism with DualFlush water-saving button, chrome					20	17,1
9M79 S1 01	TOILET SEAT AND COVER SLIMSEAT (WRAPOVER) with QuickRelease and SoftClosing hinges, hinges in stainless steel					40	2,65
9M80 S1 01	TOILET SEAT AND COVER SLIMSEAT LINE (SANDWICH) with QuickRelease and SoftClosing hinges, hinges in stainless steel					40	2,5
8M22 S1 01	TOILET SEAT AND COVER with QuickRelease and SoftClosing hinges, hinges in stainless steel					108	2,7
8701 00 00	VARIO DRAINBEND for vertical outlet 225 - 310 mm						0,74
8711 00 00	VARIO DRAINBEND for vertical outlet 136 - 225 mm						0,72

TOILET SEAT AND COVER



Article number	Description	01	RW			pcs/ pal.	kg/ pc.
8M22 S1 01	with QuickRelease and SoftClosing hinges, hinges in stainless steel					108	2,7

XX = Colour code to be indicated

01 = White Alpin, R1 = White Alpin CeramicPlus, RW = Stone White CeramicPlus

VENTICELLO

€ excl. VAT

Please order tap fittings and soap dispenser separately

TOILET SEAT AND COVER SLIMSEAT (WRAPOVER)



Article number	Description	01	RW			pcs/ pal.	kg/ pc.
9M79 S1 01	with QuickRelease and SoftClosing hinges, hinges in stainless steel		-	-	-	40	2,65

TOILET SEAT AND COVER SLIMSEAT LINE (SANDWICH)





Article number	Description	01	RW			pcs/ pal.	kg/ pc.
9M80 S1 01	with QuickRelease and SoftClosing hinges, hinges in stainless steel		-	-	-	40	2,5



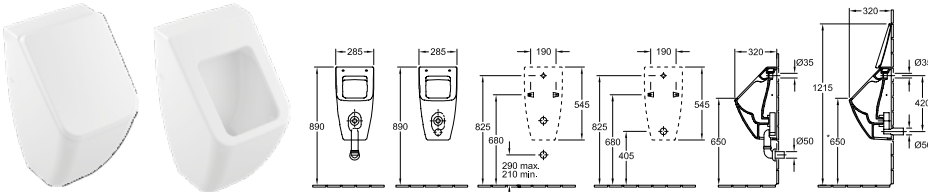





SIPHONIC URINAL

DirectFlush



Article number	Description	01	plus R1	plus RW		pcs/ pal.	kg/ pc.
5504 R1 XX	285 x 545 x 315 mm for cover		-	-	-	15	17
5504 R0 XX	285 x 545 x 315 mm without cover		-	-	-	15	17

with fastening set for concealed fastening, concealed water inlet, Outlet may be concealed depending on the type of extractor section

8M10 S1 XX	COVER with SoftClosing hinges, chrome hinges		-	-	-	240	1,3
9326 00 00	EXTRACTOR (optional) horizontal outlet, Flush volume: 1,0 l		-	-	-		0,164
9327 00 00	EXTRACTOR (optional) vertical outlet, Flush volume: 1,0 l		-	-	-		0,175
9319 00 00	CONNECTION PIECES (optional) comprising: collar, outlet elbow, drain pipe 150 mm long		-	-	-		0,232
9933 00 00	WATER-INLET CONNECTOR (optional)		-	-	-		0,2
9190 B1 00	PRODETECT 2 RADAR FLUSH CONTROL FOR URINALS (optional) electronic urinal flushing system, battery-operated (6 x 1.5 V AAA required), pipe thread inlet connector 1/2"		-	-	-		0,974
9190 N1 00	PRODETECT 2 RADAR FLUSH CONTROL FOR URINALS (optional) electronic urinal flushing system, mains-powered (110 - 240 V), Bluetooth-compatible thanks to optional adapter, pipe thread inlet connector 1/2"		-	-	-		1,006
9190 61 00	BLUETOOTH ADAPTER (optional) Bluetooth-adapter for 9190 N1 for wireless function change and maintenance, incl. free app for iOS and Android, suitable for smartphones and tablets		-	-	-		0,03
9190 57 00	ADAPTER FOR MAINS POWER SUPPLY CONNECTION (optional) recommendation: to install with power supply unit 9190 N1 00		-	-	-		0,038
9221 85 00	URINAL INSTALLATION SYSTEM FOR PRODETECT 525 x 1120 x 80 mm For further ViConnect models, see pages 368-379		-	-	-	10	7,15
9219 89 00	URINAL INSTALLATION SYSTEM 525 x 1120 x 98 mm For further ViConnect models, see pages 368-379		-	-	-		8,05

XX = Colour code to be indicated

01 = White Alpin, R1 = White Alpin CeramicPlus, RW = Stone White CeramicPlus

VENTICELLO

€ excl. VAT

Produced to order (Please note that it is not always possible to cancel or change orders!), The washbasins are to be ordered separately.

Express Delivery

These products are always available from stock in the colours: **Glossy White (DH), Glossy Grey (FP) with handle version 1**

Front:

laminated MDF in in DH, E8, FP, MS, PN (16 mm)
 painted MDF in PD (16 mm)
 direct-laminated chipboard in RH, RK, VG, VH, VJ, VK (16 mm)
 direct-laminated chipboard (16 mm) with glass finish (3 mm) painted in RA, RE
 horizontal grain in E8, PN, RH, RK, VH, VJ
 matching interior colour for DH, FP
 interior colour to match décor for E8, MS, RH, RK, VG, VH, VJ, VK
 interior colour Anthracite for PD

Body:

laminated MDF in DH, FP, RA, RE (16 mm)
 painted MDF in PD (16 mm)
 direct-laminated chipboard in E8, MS, PN, RH, RK, VG, VH, VJ, VK (16 mm)
 horizontal grain in E8, PN, RH, RK, VH, VJ
 matching interior colour for DH, FP
 interior colour to match décor for E8, MS, RH, RK, VG, VH, VJ, VK

interior colour Anthracite for PD

Washbasin countertop:

painted MDF in in DH, FP, PD, RA, RE (16 mm)
 direct-laminated chipboard in E8, MS, PN, RH, RK, VG, VH, VJ, VK (16 mm)

Drawers:

Slip-resistant base
 SoftClosing feature

Doors:

SoftClosing feature

Handles:

painted aluminium in White (2)
 chrome-plated aluminium in Chrome (1)
 copper-plated aluminium in Copper (5)

Interior compartments :

adjustable glass partitions (8 mm)
 accessory boxes made of grey translucent plastic

Please note:

For further information such as tap fitting positions, installation and fastening dimensions etc. please see the technical drawings.

	HANDLE	HANDLE	HANDLE
Colour	handle Chrome	handle White	handle Copper

	ACCESSORIES PACKAGE 1
Equipped with	1x wide glass drawer divider 2x narrow glass drawer divider 1x accessory box L

	VANITY UNIT	VANITY UNIT	VANITY UNIT	VANITY UNIT
Article number	A939 0Z XX	A930 0Z XX	A938 0Z XX	A929 0Z XX
Dimensions (w x h x d)	1253 x 420 x 502 mm	1253 x 590 x 502 mm	1153 x 420 x 502 mm	1153 x 590 x 502 mm
Version	washbasin on the middle	washbasin on the middle	washbasin on the middle	washbasin on the middle
For combination with	Venticello 4111 DL/DJ	Venticello 4111 DL/DJ	Venticello 4104 CL/CJ	Venticello 4104 CL/CJ
Equipped with	2x Accessories package 1 2x pull-out compartment with non-slip mat	2x Accessories package 1 4x pull-out compartment with non-slip mat	2x Accessories package 1 2x pull-out compartment with non-slip mat	2x Accessories package 1 4x pull-out compartment with non-slip mat
Installation	wall-mounted	wall-mounted	wall-mounted	wall-mounted
Scope of delivery	fastening set included, space saving siphon	fastening set included	fastening set included, space saving siphon	fastening set included
Please note	-	-	vanity washbasin 4104 CK only available in combination with a push-open valve	vanity washbasin 4104 CK only available in combination with a push-open valve
DH, E8, FP, MS, PN, RH, RK, VG, VH, VJ, VK				
PD, RA, RE				

XX = Insert front and body colour
 DH = Glossy White, FP = Glossy Grey, MS = White Matt, PD = Black Matt Lacquer, VG = Truffle Grey, VK = Soft Grey, E8 = White Wood, PN = Elm Impreso, RH = Oak Kansas, RK = Stone Oak, VH = Arizona Oak, VJ = Nordic Oak

XX = Insert front colour
 RA = Glass Glossy Grey, RE = Glass Glossy White

Z = Handle code to be indicated
 1 = Chrome, 2 = White, 5 = Copper

VENTICELLO











VENTICELLO

€ excl. VAT

Produced to order (Please note that it is not always possible to cancel or change orders!), The washbasins are to be ordered separately.

Express Delivery

These products are always available from stock in the colours: **Glossy White (DH), Glossy Grey (FP) with handle version 1**

	VANITY UNIT	VANITY UNIT	VANITY UNIT	VANITY UNIT
	  			
		 		
Article number	A935 0Z XX	A926 0Z XX	A927 0Z XX	A928 0Z XX
Dimensions (w x h x d)	953 x 420 x 502 mm	953 x 590 x 502 mm	953 x 590 x 502 mm	953 x 590 x 502 mm
Version	washbasin on the middle	washbasin on the middle	washbasin on the middle	washbasin on the middle
For combination with	Venticello 4104 AK/AL/AJ Venticello 4134 L1/L3 Venticello 4134 R1/R3	Venticello 4104 AL/AJ	Venticello 4134 L1/L3	Venticello 4134 R1/R3
Equipped with	1x Accessories package 1 1x pull-out compartment with non-slip mat	1x Accessories package 1 2x pull-out compartment with non-slip mat	1x Accessories package 1 2x pull-out compartment with non-slip mat	1x Accessories package 1 2x pull-out compartment with non-slip mat
Installation	wall-mounted	wall-mounted	wall-mounted	wall-mounted
Scope of delivery	fastening set included, space saving siphon	fastening set included	fastening set included	fastening set included
Please note	-	vanity washbasin 4104 AK only available in combination with a push-open valve	-	-
DH, E8, FP, MS, PN, RH, RK, VG, VH, VJ, VK				
PD, RA, RE				

VENTICELLO

XX = Insert front and body colour
 DH = Glossy White, FP = Glossy Grey, MS = White Matt, PD = Black Matt Lacquer, VG = Truffle Grey, VK = Soft Grey, E8 = White Wood, PN = Elm Impreso, RH = Oak Kansas, RK = Stone Oak, VH = Arizona Oak, VJ = Nordic Oak

XX = Insert front colour
 RA = Glass Glossy Grey, RE = Glass Glossy White

Z = Handle code to be indicated
 1 = Chrome, 2 = White, 5 = Copper

VENTICELLO

€ excl. VAT

Produced to order (Please note that it is not always possible to cancel or change orders!), The washbasins are to be ordered separately.

Express Delivery

These products are always available from stock in the colours: **Glossy White (DH), Glossy Grey (FP) with handle version 1**

	VANITY UNIT	VANITY UNIT	VANITY UNIT	VANITY UNIT
Article number	A934 0Z XX	A925 0Z XX	A933 0Z XX	A924 0Z XX
Dimensions (w x h x d)	753 x 420 x 502 mm	753 x 590 x 502 mm	603 x 420 x 502 mm	603 x 590 x 502 mm
Version	washbasin on the middle	washbasin on the middle	washbasin on the middle	washbasin on the middle
For combination with	Venticello 4104 8L/8J	Venticello 4104 8L/8J	Venticello 4124 65/67	Venticello 4124 65/67
Equipped with	1x Accessories package 1 1x pull-out compartment with non-slip mat	1x Accessories package 1 2x pull-out compartment with non-slip mat	1x Accessories package 1 1x pull-out compartment with non-slip mat	1x Accessories package 1 2x pull-out compartment with non-slip mat
Installation	wall-mounted	wall-mounted	wall-mounted	wall-mounted
Scope of delivery	fastening set included, space saving siphon	fastening set included	fastening set included, space saving siphon	fastening set included
DH, E8, FP, MS, PN, RH, RK, VG, VH, VJ, VK				
PD, RA, RE				
	VANITY UNIT	VANITY UNIT	VANITY UNIT	VANITY UNIT
Article number	A932 0Z XX	A923 0Z XX	A931 0Z XX	A922 0Z XX
Dimensions (w x h x d)	553 x 420 x 502 mm	553 x 590 x 502 mm	466 x 420 x 425 mm	466 x 590 x 425 mm
Version	washbasin on the middle	washbasin on the middle	washbasin on the middle	washbasin on the middle
For combination with	Venticello 4124 60/62	Venticello 4124 60/62	Venticello 4124 50	Venticello 4124 50
Equipped with	1x Accessories package 1 1x pull-out compartment with non-slip mat	1x Accessories package 1 2x pull-out compartment with non-slip mat	1x accessory box L 1x pull-out compartment with non-slip mat	1x accessory box L 2x pull-out compartment with non-slip mat
Installation	wall-mounted	wall-mounted	wall-mounted	wall-mounted
Scope of delivery	fastening set included, space saving siphon	fastening set included	fastening set included, space saving siphon	fastening set included
DH, E8, FP, MS, PN, RH, RK, VG, VH, VJ, VK				
PD, RA, RE				

XX = Insert front and body colour
 DH = Glossy White, FP = Glossy Grey, MS = White Matt, PD = Black Matt Lacquer, VG = Truffle Grey, VK = Soft Grey, E8 = White Wood, PN = Elm Impreso, RH = Oak Kansas, RK = Stone Oak, VH = Arizona Oak, VJ = Nordic Oak

XX = Insert front colour
 RA = Glass Glossy Grey, RE = Glass Glossy White

Z = Handle code to be indicated
 1 = Chrome, 2 = White, 5 = Copper

VENTICELLO

€ excl. VAT

Produced to order (Please note that it is not always possible to cancel or change orders!), The washbasins are to be ordered separately.

Express Delivery

These products are always available from stock in the colours: **Glossy White (DH), Glossy Grey (FP) with handle version 1**

	VANITY UNIT	VANITY UNIT	VANITY UNIT	VANITY UNIT
Article number	A949 0Z XX	A944 0Z XX	A946 0Z XX	A941 0Z XX
Dimensions (w x h x d)	1257 x 436 x 502 mm	1257 x 606 x 502 mm	957 x 436 x 502 mm	957 x 606 x 502 mm
Version	for 2 washbasins	for 2 washbasins	washbasin on the middle	washbasin on the middle
For combination with	Venticello 4113 55	Venticello 4113 55	Venticello 4113 55	Venticello 4113 55
Equipped with	2x Accessories package 1 2x pull-out compartment with non-slip mat	2x Accessories package 1 4x pull-out compartment with non-slip mat	1x Accessories package 1 1x pull-out compartment with non-slip mat	1x Accessories package 1 2x pull-out compartment with non-slip mat
Installation	wall-mounted	wall-mounted	wall-mounted	wall-mounted
Scope of delivery	fastening set included	fastening set included	fastening set included	fastening set included
DH, E8, FP, MS, PN, RH, RK, VG, VH, VJ, VK PD, RA, RE				
	VANITY UNIT	VANITY UNIT	VANITY UNIT	VANITY UNIT
Article number	A947 0Z XX	A948 0Z XX	A942 0Z XX	A943 0Z XX
Dimensions (w x h x d)	957 x 436 x 502 mm	957 x 436 x 502 mm	957 x 606 x 502 mm	957 x 606 x 502 mm
Version	washbasin on left	washbasin on right	washbasin on left	washbasin on right
For combination with	Venticello 4113 55	Venticello 4113 55	Venticello 4113 55	Venticello 4113 55
Equipped with	1x Accessories package 1 1x pull-out compartment with non-slip mat	1x Accessories package 1 1x pull-out compartment with non-slip mat	1x Accessories package 1 2x pull-out compartment with non-slip mat	1x Accessories package 1 2x pull-out compartment with non-slip mat
Installation	wall-mounted	wall-mounted	wall-mounted	wall-mounted
Scope of delivery	fastening set included	fastening set included	fastening set included	fastening set included
DH, E8, FP, MS, PN, RH, RK, VG, VH, VJ, VK PD, RA, RE				

VENTICELLO

XX = Insert front and body colour
 DH = Glossy White, FP = Glossy Grey, MS = White Matt, PD = Black Matt Lacquer, VG = Truffle Grey, VK = Soft Grey, E8 = White Wood, PN = Elm Impresso, RH = Oak Kansas, RK = Stone Oak, VH = Arizona Oak, VJ = Nordic Oak

XX = Insert front colour
 RA = Glass Glossy Grey, RE = Glass Glossy White

Z = Handle code to be indicated
 1 = Chrome, 2 = White, 5 = Copper

VENTICELLO

€ excl. VAT

Produced to order (Please note that it is not always possible to cancel or change orders!), The washbasins are to be ordered separately.

Express Delivery

These products are always available from stock in the colours: **Glossy White (DH), Glossy Grey (FP) with handle version 1**

	VANITY UNIT	VANITY UNIT
Article number	A945 0Z XX	A940 0Z XX
Dimensions (w x h x d)	757 x 436 x 502 mm	757 x 606 x 502 mm
Version	washbasin on the middle	washbasin on the middle
For combination with	Venticello 4113 55	Venticello 4113 55
Equipped with	1x Accessories package 1 1x pull-out compartment with non-slip mat	1x Accessories package 1 2x pull-out compartment with non-slip mat
Installation	wall-mounted	wall-mounted
Scope of delivery	fastening set included	fastening set included
DH, E8, FP, MS, PN, RH, RK, VG, VH, VJ, VK		
PD, RA, RE		

	TALL CABINET	TALL CABINET	TALL CABINET	TALL CABINET
Article number	A951 0Z XX	A951 1Z XX	A952 0Z XX	A952 1Z XX
Dimensions (w x h x d)	404 x 1546 x 372 mm	404 x 1546 x 372 mm	404 x 1546 x 372 mm	404 x 1546 x 372 mm
Hinges	hinges on left	hinges on right	hinges on left	hinges on right
Equipped with	1x door 3x glass shelf 1x fixed shelf	1x door 3x glass shelf 1x fixed shelf	1x door 1x open compartment 2x pull-out compartment with non-slip mat 2x glass shelf 2x fixed shelf	1x door 1x open compartment 2x pull-out compartment with non-slip mat 2x glass shelf 2x fixed shelf
Installation	wall-mounted	wall-mounted	wall-mounted	wall-mounted
Scope of delivery	fastening set included	fastening set included	fastening set included	fastening set included
DH, E8, FP, MS, PN, RH, RK, VG, VH, VJ, VK				
PD, RA, RE				

VENTICELLO

XX = Insert front and body colour
 DH = Glossy White, FP = Glossy Grey, MS = White Matt, PD = Black Matt Lacquer, VG = Truffle Grey, VK = Soft Grey, E8 = White Wood, PN = Elm Impreso, RH = Oak Kansas, RK = Stone Oak, VH = Arizona Oak, VJ = Nordic Oak

XX = Insert front colour
 RA = Glass Glossy Grey, RE = Glass Glossy White

Z = Handle code to be indicated
 1 = Chrome, 2 = White, 5 = Copper

VENTICELLO



€ excl. VAT

Produced to order (Please note that it is not always possible to cancel or change orders!), The washbasins are to be ordered separately.

Express Delivery

These products are always available from stock in the colours: **Glossy White (DH), Glossy Grey (FP) with handle version 1**

	SIDE CABINET	SIDE CABINET
		
Article number	A950 0Z XX	A950 1Z XX
Dimensions (w x h x d)	404 x 866 x 372 mm	404 x 866 x 372 mm
Hinges	hinges on left	hinges on right
Equipped with	1x door 1x drawer with non-slip mat 1x glass shelf	1x door 1x drawer with non-slip mat 1x glass shelf
Installation	wall-mounted	wall-mounted
Scope of delivery	fastening set included	fastening set included
DH, E8, FP, MS, PN, RH, RK, VG, VH, VJ, VK		
PD, RA, RE		

	CUPBOARD UNIT	CUPBOARD UNIT
		
		<small>Express Delivery</small>
Article number	A953 0Z XX	A954 0Z XX
Dimensions (w x h x d)	400 x 359 x 502 mm	400 x 529 x 502 mm
Version	right/left/middle, to attach to vanity unit	right/left/middle, to attach to vanity unit
Equipped with	1x pull-out compartment with non-slip mat 1x accessory box L	2x pull-out compartment with non-slip mat 1x accessory box L
Installation	wall-mounted	wall-mounted
Scope of delivery	fastening set included	fastening set included
DH, E8, FP, MS, PN, RH, RK, VG, VH, VJ, VK		
PD, RA, RE		

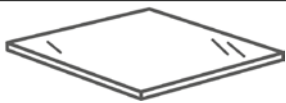
	COVER PLATE
	
Article number	A299 00 XX
Dimensions (w x h x d)	400 x 3 x 478 mm
Material	of glass
For combination with	Optional glass countertops for the Venticello cupboard units A953 0Z XX and A954 0Z XX
RA, RE	

XX = Insert front and body colour
 DH = Glossy White, FP = Glossy Grey, MS = White Matt, PD = Black Matt Lacquer, VG = Truffle Grey, VK = Soft Grey, E8 = White Wood, PN = Elm Impresso, RH = Oak Kansas, RK = Stone Oak, VH = Arizona Oak, VJ = Nordic Oak

XX = Insert front colour
 RA = Glass Glossy Grey, RE = Glass Glossy White

Z = Handle code to be indicated
 1 = Chrome, 2 = White, 5 = Copper

VICLEAN

Bath ceramic

- enjoy a pleasant shower-fresh feeling with Villeroy & Boch's ViClean shower toilets
- ViClean provides a comfortable cleaning action with a gentle, warm jet of water
- it relaxes, invigorates and makes daily hygiene a pleasure for both body and mind

PRO.VILLEROY-BOCH.COM/TECHNICALDRAWINGS



VICLEAN



Ceramic colours



R1 = White Alpin
CeramicPlus





S0 = Glossy
Black
CeramicPlus

The product supplied by Villeroy & Boch meets all legal requirements of the EU with regard to placing on the market. Conformity with the requirements of countries outside the EU cannot be confirmed. The customer declares that he will take care of any necessary approvals and registrations for the sale of the product itself and will exempt Villeroy & Boch from any claims due to missing or insufficient documentation, certifications or other necessary requirements of the product for the respective country of sale outside the EU.

VICLEAN

VICLEAN

Functions	ViClean-I 100	ViClean-L
		
SHOWER FUNCTION		
Rearwash	○	○
Ladywash	○	○
Innovative comfort wash/HarmonicWave shower spray	○	-
Innovative comfort wash/Panorama shower spray	-	○
Innovative comfort wash Baloonjet	-	-
Adjustment of temperature, jet pressure and nozzle position	5	3
Unlimited warm water supply thanks to instant water heater	○	○
HYGIENE		
Automatic cleaning of the nozzle with fresh water both before and after each toilet use	○	○
DirectFlush technology	○	○
CeramicPlus surface finish	○	○
QuickRelease mechanism	○	-
InvisibleJet technology	○	-
Duroplast toilet seat	○	-
COMFORT		
SoftClosing feature	○	○
incl. remote control	○	○
heated seat	-	○
Air temperature control (levels)	-	3
Night light	-	○
User settings	via app	3
User settings via App	○	-
Air dryer	-	-
Air temperature control in steps	-	-
Automatic odour extraction	-	-
Automatic open/close seat and lid	-	-
ViClean App	○	-
DESIGN		
Concealed supply connections	○	○

VICLEAN

€ excl. VAT

Details for Conformity requirements see entry page ViClean

SHOWER TOILET, RIMLESS

ViClean-I 100, DirectFlush

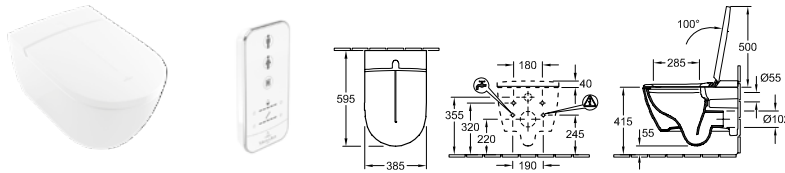

* Position of water and power connections in conjunction with ViConnect (Art. no 9224 61 00)

Article number	Description	01	plus R1	plus S0		pcs/ pal.	kg/ pc.
V0E1 00 XX	385 x 595 mm, individual packaging materials	-	-	-	-	6	34

composed of:

ViClean shower toilet-I 100, 385 x 595 x 400 mm, 220-240 V AC / 50 Hz

incl. remote control

seat with lid

Water connection set, wall-mounted, horizontal outlet, fastening set included, with water-saving AQUAREDUCT® system: flush volume 3 / 4,5 litres, Power and water connection must be available, Use only in working pressure range between 0.1 Mpa (dynamic) and 1.0 Mpa (static), Use solely in a water temperature range between 10°C and 35°C

9218 51 00	ROUGHING-IN SET for concealed water connection consisting of: mounting plate, conduit only for installation with ViConnect WC element and ViClean toilet seat	-	-	-	-		0,3
9224 27 00	TOILET INSTALLATION SYSTEM for dry-wall construction standard height 525 x 1120 x 135 mm For further ViConnect models, see pages 368-379	-	-	-	-	10	15,8

ELECTRONIC BIDET SEAT

ViClean-L



Article number	Description	01	plus R1	plus S0		pcs/ pal.	kg/ pc.
V02E L4 01	392 x 537 x 141 mm 220-240 V AC/50Hz (Phase-out date 31.12.2021)	-	-	-	-	20	4,4

only for Subway 2.0 washdown WC DirectFlush 5614 R5 R1, only for Subway 2.0 washdown WC 5600 50 R1, incl. remote control, fastening set included, Power and water connection must be available, Use only in working pressure range between 0.11 Mpa (dynamic) and 0.68 Mpa (static), The water temperature must be between 0°C and 35°C.

V990 19 00	WATER CONNECTION SET (required) angle valve 1/2" x 3/8", water connection hose 1/2" x 3/8", 300 mm long	-	-	-	-		0,202
V990 00 00	WATER CONNECTION SET (APAC) (required) for wall-mounted toilets, angle valve 1/2" x 1/2", water connection hose 1/2" x 1/2", 300 mm long	-	-	-	-		0,226

XX = Colour code to be indicated

R1 = White Alpin CeramicPlus, S0 = Glossy Black CeramicPlus

VICLEAN





€ excl. VAT

Details for Conformity requirements see entry page ViClean

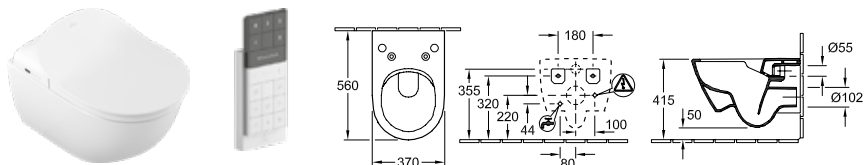

WASHDOWN TOILET, RIMLESS

ViClean-L, DirectFlush



Article number	Description	01	plus R1	plus S0		pcs/ pal.	kg/ pc.
5614 R5 R1	370 x 560 mm    	-	-	-	-	12	25,8

wall-mounted, horizontal outlet, incl. fastening set "SupraFix 3.0", with water-saving AQUAREDUCT® system: flush volume 3 / 4,5 litres, not suitable for installation with flush valves, only for ViClean-L smart toilet seat

V02E L4 01	ELECTRONIC BIDET SEAT (Phase-out date 31.12.2021) Please order compatible toilet separately. 392 x 537 x 141 mm, 220-240 V AC/50Hz, Power and water connection must be available, Use only in working pressure range between 0.11 Mpa (dynamic) and 0.68 Mpa (static), The water temperature must be between 0°C and 35°C., incl. remote control, fastening set included 	-	-	-	-	20	4,4
V990 00 00	WATER CONNECTION SET (APAC) (required) for wall-mounted toilets, angle valve 1/2" x 1/2", water connection hose 1/2" x 1/2", 300 mm long	-	-	-	-		0,226
V990 19 00	WATER CONNECTION SET (required) angle valve 1/2" x 3/8", water connection hose 1/2" x 3/8", 300 mm long	-	-	-	-		0,202
9222 87 00	VIPROTECT SOUNDPROOFING SET (optional) incl. accessories	-	-	-	-	600	0,086
9224 65 00	TOILET INSTALLATION SYSTEM for dry-wall construction low 450 x 1120 x 165 mm For further ViConnect models, see pages 368-379 	-	-	-	-	8	19,78
9224 27 00	TOILET INSTALLATION SYSTEM for dry-wall construction standard height 525 x 1120 x 135 mm For further ViConnect models, see pages 368-379 	-	-	-	-	10	15,8
9218 51 00	ROUGHING-IN SET for concealed water connection consisting of: mounting plate, conduit only for installation with ViConnect WC element and ViClean toilet seat	-	-	-	-		0,3
9219 80 00	CONNECTION SET for concealed water connection consisting of: T-piece, flexible hose 1300 mm with cap nut 1/2" x 1/2" only for installation with ViConnect WC element and ViClean-L toilet seat	-	-	-	-		0,5

XX = Colour code to be indicated
R1 = White Alpin CeramicPlus, S0 = Glossy Black CeramicPlus





VICLEAN

€ excl. VAT

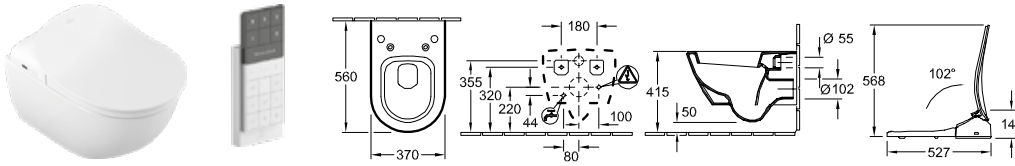
Details for Conformity requirements see entry page ViClean

WASHDOWN TOILET ViClean-L



Article number	Description	01	plus R1	plus S0		pcs/ pal.	kg/ pc.
5600 50 R1	370 x 560 mm   ViClean	-	-	-	-	12	27
wall-mounted, horizontal outlet, incl. fastening set "SupraFix 3.0", with water-saving AQUAREDUCT® system: flush volume 3 / 4,5 litres, only for ViClean-L smart toilet seat							
V02E L4 01	ELECTRONIC BIDET SEAT (Phase-out date 31.12.2021) Please order compatible toilet separately. 392 x 537 x 141 mm, 220-240 V AC/50Hz, Power and water connection must be available. Use only in working pressure range between 0.11 Mpa (dynamic) and 0.68 Mpa (static), The water temperature must be between 0°C and 35°C., incl. remote control, fastening set included 	-	-	-	-	20	4,4
V990 00 00	WATER CONNECTION SET (APAC) (required) for wall-mounted toilets, angle valve 1/2" x 1/2", water connection hose 1/2" x 1/2", 300 mm long	-	-	-	-		0,226
V990 19 00	WATER CONNECTION SET (required) angle valve 1/2" x 3/8", water connection hose 1/2" x 3/8", 300 mm long	-	-	-	-		0,202
9222 87 00	VIPROTECT SOUNDPROOFING SET (optional) incl. accessories	-	-	-	-	600	0,086
9224 65 00	TOILET INSTALLATION SYSTEM for dry-wall construction low 450 x 1120 x 165 mm For further ViConnect models, see pages 368-379 	-	-	-	-	8	19,78
9224 27 00	TOILET INSTALLATION SYSTEM for dry-wall construction standard height 525 x 1120 x 135 mm For further ViConnect models, see pages 368-379 	-	-	-	-	10	15,8
9218 51 00	ROUGHING-IN SET for concealed water connection consisting of: mounting plate, conduit only for installation with ViConnect WC element and ViClean toilet seat	-	-	-	-		0,3
9219 80 00	CONNECTION SET for concealed water connection consisting of: T-piece, flexible hose 1300 mm with cap nut 1/2" x 1/2" only for installation with ViConnect WC element and ViClean-L toilet seat	-	-	-	-		0,5

XX = Colour code to be indicated
R1 = White Alpin CeramicPlus, S0 = Glossy Black CeramicPlus

VICONNECT INSTALLATION SYSTEMS

PRO.VILLEROY-BOCH.COM/TECHNICALDRAWINGS



- Installation systems and flush plates
- Design plates in various materials and colours for all price categories
- Toilet elements to match all wall-mounted toilets (standard, compact, Vita) and floor-standing, back-to-wall toilets
- Toilet elements for dry and wet-wall construction
- Toilet elements for use with SupraFix 3.0, DirectFlush and ViClean
- 25-year availability guarantee on spare parts

VICONNECT
INSTALLATION
SYSTEMS



Flush plate colours



61 = Chrome



68 = White



69 = Brushed
Chrome



AN = Black Matt



D8 = Anthracite
Matt



LC = Stainless
steel



N5 = White Matt



RA = Glass
Glossy Grey



RB = Glass
Glossy Black



RE = Glass
Glossy White

VICONNECT INSTALLATION SYSTEMS

€ excl. VAT

TOILET INSTALLATION SYSTEM

for dry-wall construction, standard height

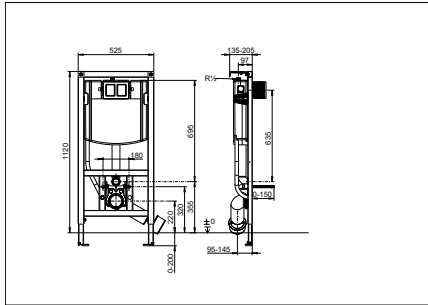

Article number	Description		pcs/ pal.	kg/ pc.
9224 27 00	525 x 1120 x 135 mm self-supporting powder-coated steel frame, fully pre-assembled, front operated		10	15,8
<p>for wall-mounted WC, for covering with plasterboard, installation on a solid brick wall, in dry-wall constructions etc., Easy connection to flush plate via flexible cables with bayonet joint, adjustment range of feet from unfinished floor level to upper edge of finished floor level: 0-200mm, depth adjustment front edge of element: 135-205 mm, incl. 2 wall mounts, concealed cistern insulated against condensation water, with dual flush (7.5-4.5 l / 4-2 l), factory setting 6/3 l, filling valve Noise Class I, 2-part angle valve connection set R1/2, drain bend clamp, 4 adjustment settings, PE toilet connecting bend DN 90 (Ø 90) with reducing sleeve DN 90 (Ø 90) / DN 100 (Ø 110) with protection plugs, complete WC connection set DN 90 (Ø 90) / 180 mm, protection box for access opening can be cut to size, flexible hose for filling valve, can be tightened by hand, adjustable flush flow control for adaptation to rimless toilet bowls, certification marks for concealed cistern: Noise Class I, with factory-fitted conduit for shower toilet connection/wiring, ViConnect water connection set V990 84, incl. self-locking feet with adjustable base plates and fastening materials, incl. 2 wall mounts, 2 times M12 WC retaining bolts adjustable to 180/230mm with protection plugs and nuts, installation instructions, without flush plate, packaged in a box</p>				
9219 80 00	CONNECTION SET only for installation with ViConnect toilet element and ViClean-L toilet seat			0,5
9221 15 00	CONCEALED CONNECTION SET only for installation with ViConnect toilet element and ViClean-U+ toilet seat			0,305
9223 85 00	EXTENSION SET FOR FLUSH PLATES			0,2
9221 40 00	ODOR EXTRACTION SET			0,4

TOILET INSTALLATION SYSTEM

for dry-wall construction, low, installation height 1120 mm

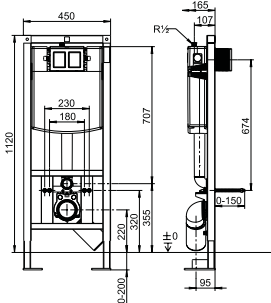

Article number	Description		pcs/ pal.	kg/ pc.
9224 65 00	450 x 1120 x 165 mm self-supporting powder-coated steel frame, fully pre-assembled		8	19,78

for wall-mounted WC, for covering with plasterboard, for free-standing installation, adjustment range of feet from unfinished floor level to upper edge of finished floor level: 0-200mm, adjustment range front to wall: 165-215mm, 2-point fastening, concealed cistern with insulation against condensation with dual flush 3/6 l, maximal flush quantity 7.5 l, filling valve Noise Class I, flexible hose for filling valve, can be tightened by hand, 2-part angle valve connection set R1/2, mounting clip, 4 adjustment settings, protection box for access opening can be cut to size, with depth-adjustable WC connecting bend 90° DN 90 (Ø 90) / DN 100 (Ø 110) with protection cap, complete WC connection set DN 90 (Ø 90) / 180 mm, certification marks for concealed cistern: Noise Class I, with wall brackets, includes heavy-duty support feet and fastening materials, with protection cap for the flushing pipe, 2 times M12 WC retaining bolts adjustable to 180/230mm with protection plugs and nuts, installation instructions, without flush plate, individual packaging materials

Combi-pack ViConnect/O.novo: WC 5660 R0 01 + WC element, standard hight, + push-plate 9224 90, see page 264

XX = Colour code to be indicated
 61 = Chrome, 68 = White, 69 = Brushed Chrome, AN = Black Matt, D8 = Anthracite Matt, LC = Stainless steel, N5 = White Matt,
 RA = Glass Glossy Grey, RB = Glass Glossy Black, RE = Glass Glossy White

VICONNECT
INSTALLATION
SYSTEMS

VICONNECT INSTALLATION SYSTEMS

€ excl. VAT

TOILET INSTALLATION SYSTEM

for dry-wall construction, low, installation height 820 mm

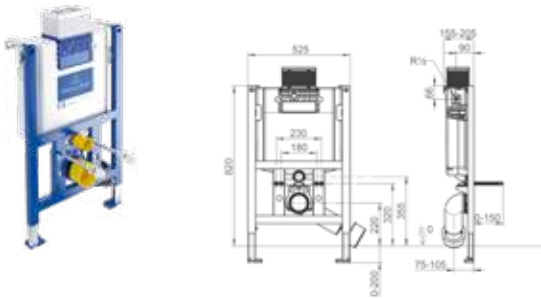



Article number	Description		pcs/pal.	kg/pc.
9224 75 00	525 x 820 x 155 mm self-supporting powder-coated steel frame, fully pre-assembled, front/top operated, with small access opening		14	13,85

for wall-mounted WC, for covering with plasterboard, installation on a solid brick wall, in dry-wall constructions etc., adjustment range of feet from unfinished floor level to upper edge of finished floor level: 0-200mm, Easy connection to flush plate via flexible cables with bayonet joint, depth adjustment front edge of element: 135-205 mm, 4 wall-mounted fastening points, concealed cistern with insulation against condensation with dual flush, maximal flush quantity 4/7,5 l, factory setting 6/3 l, filling valve Noise Class I, corner valve R1/2, drain bend clamp, 4 adjustment settings, PE toilet connecting bend DN 90 (Ø 90) with reducing sleeve DN 90 (Ø 90) / DN 100 (Ø 110) with protection plugs, complete WC connection set DN 90 (Ø 90) / 180 mm, protection box for access opening can be cut to size, flexible hose for filling valve, can be tightened by hand, certification marks for concealed cistern: Noise Class I, incl. 2 wall mounts, incl. self-locking feet with adjustable base plates and fastening materials, 2 times M12 WC retaining bolts adjustable to 180/230mm with protection plugs and nuts, installation instructions, without flush plate, packaged in a box

TOILET INSTALLATION SYSTEM

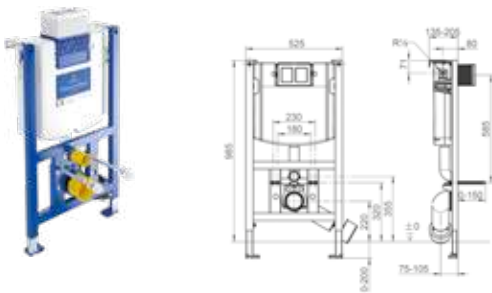
for dry-wall construction, low, installation height 980 mm



Article number	Description		pcs/pal.	kg/pc.
9224 78 00	525 x 985 x 135 mm self-supporting powder-coated steel frame, fully pre-assembled, front/top operated, with small access opening	 	11	14,46

for wall-mounted WC, for covering with plasterboard, installation on a solid brick wall, in dry-wall constructions etc., Easy connection to flush plate via flexible cables with bayonet joint, adjustment range of feet from unfinished floor level to upper edge of finished floor level: 0-200mm, depth adjustment front edge of element: 135-205 mm, 4 wall-mounted fastening points, concealed cistern insulated against condensation water, with dual flush (7.5-4.5 l / 4-2 l), maximal flush quantity 4/7,5 l, factory setting 6/3 l, adjustable flush flow control for adaptation to rimless toilet bowls, filling valve Noise Class I, corner valve R1/2, drain bend clamp, 4 adjustment settings, PE toilet connecting bend DN 90 (Ø 90) with reducing sleeve DN 90 (Ø 90) / DN 100 (Ø 110) with protection plugs, complete WC connection set DN 90 (Ø 90) / 180 mm, protection box for access opening can be cut to size, flexible hose for filling valve, can be tightened by hand, certification marks for concealed cistern: Noise Class I, incl. 2 wall mounts, incl. self-locking feet with adjustable base plates and fastening materials, 2 times M12 WC retaining bolts adjustable to 180/230mm with protection plugs and nuts, installation instructions, without flush plate, packaged in a box

Combi-pack ViConnect/O.novo: WC 5660 R0 01 + WC element, standard hight, + push-plate 9224 90, see page 264

XX = Colour code to be indicated
61 = Chrome, 68 = White, 69 = Brushed Chrome, AN = Black Matt, D8 = Anthracite Matt, LC = Stainless steel, N5 = White Matt,
RA = Glass Glossy Grey, RB = Glass Glossy Black, RE = Glass Glossy White

VICONNECT INSTALLATION SYSTEMS

€ excl. VAT

TOILET INSTALLATION SYSTEM COMPACT

for dry-wall construction, Compact, with cistern 80 mm, installation depth min. 90 mm

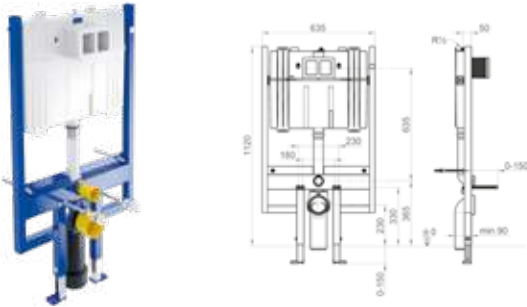

Article number	Description		pcs/ pal.	kg/ pc.
9224 76 00	635 x 1120 x 90 mm self-supporting powder-coated steel frame, fully pre-assembled		10	13,8

for wall-mounted WC, for covering with plasterboard, installation on a solid brick wall, in dry-wall constructions etc., Easy connection to flush plate via flexible cables with bayonet joint, adjustment range of feet from unfinished floor level to upper edge of finished floor level: 0-200mm, adjustment range front to wall: min 90 mm, with cistern 80 mm, 6-point fastening, concealed cistern with insulation against condensation with dual flush 3/6 l, adjustable to 3/4,5 l, maximal flush quantity 7.5 l, filling valve Noise Class I, flexible hose for filling valve, can be tightened by hand, angle valve connection set G1/2, protection box for access opening can be cut to size, WC connecting bend 90° DN 90 (Ø 90) / with reducing sleeve DN 90 (Ø 90) / DN 110 (Ø 110) with protection cap, complete WC connection set DN 90 (Ø 90) / 180 mm, certification marks for concealed cistern: Noise Class I, with wall brackets, incl. feet and fastenings, 2 times M12 WC retaining bolts adjustable to 180mm with protection plugs and nuts, installation instructions, fastening materials, without flush plate, individual packaging materials

FASTENING ELEMENTS FOR HANDLES

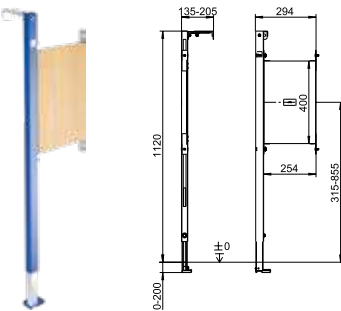

Article number	Description		pcs/ pal.	kg/ pc.
9219 83 00	310 x 1150 x 55 mm for barrier-free installation of a folding support		24	4,7

for covering with plasterboard, for assembly to left of toilet element 9224 27, incl. self-locking feet with adjustable base plates, fastening materials

FASTENING ELEMENTS FOR HANDLES

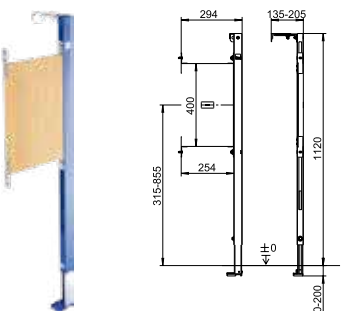

Article number	Description		pcs/ pal.	kg/ pc.
9221 09 00	310 x 1150 x 135 mm for barrier-free installation of a folding support		24	5,35

for covering with plasterboard, for assembly to right of toilet element 9224 27, incl. self-locking feet with adjustable base plates, fastening materials

Combi-pack ViConnect/O.novo: WC 5660 R0 01 + WC element, standard hight, + push-plate 9224 90, see page 264

XX = Colour code to be indicated
61 = Chrome, 68 = White, 69 = Brushed Chrome, AN = Black Matt, D8 = Anthracite Matt, LC = Stainless steel, N5 = White Matt,
RA = Glass Glossy Grey, RB = Glass Glossy Black, RE = Glass Glossy White

VICONNECT
INSTALLATION
SYSTEMS

VICONNECT INSTALLATION SYSTEMS

€ excl. VAT

CONCEALED CISTERN WITH METAL FRAME

for brick-wall construction, installation depth 125 mm

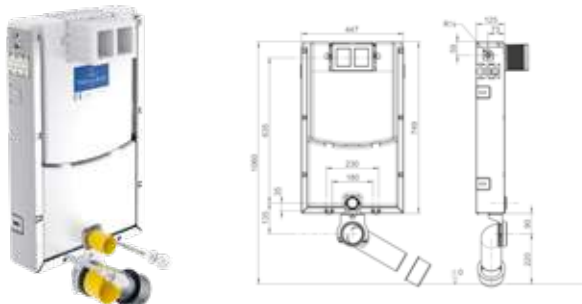



Article number	Description		pcs/pal.	kg/pc.
9224 79 00	447 x 749 x 125 mm comprising a U-shaped galvanized support frame with 6 fastening lugs		11	7,1

for wall-mounted WC, installation on or in front of a solid brick wall. Easy connection to flush plate via flexible cables with bayonet joint, flexible hose for filling valve, can be tightened by hand, protection box for access opening can be cut to size, Toilet connecting bend 90° DN 90 (Ø 90) / with reducing sleeve DN 90 (Ø 90) / DN 110 (Ø 110) with protection cap, Complete toilet connection set DN 90 (Ø 90) / 180 mm, concealed cistern with insulation against condensation with dual flush 3/6 l, adjustable to 3/4,5 l, maximal flush quantity 7.5 l, filling valve Noise Class I, 2-part angle valve connection set R1/2, mounting clip for drain bend, 4 adjustment settings, certification marks for concealed cistern: Noise Class I, adjustable flush flow control for adaptation to rimless toilet bowls, M12 WC fastening materials, fastening materials, without flush plate, individual packaging materials

CONCEALED CISTERN WITH METAL FRAME COMPACT

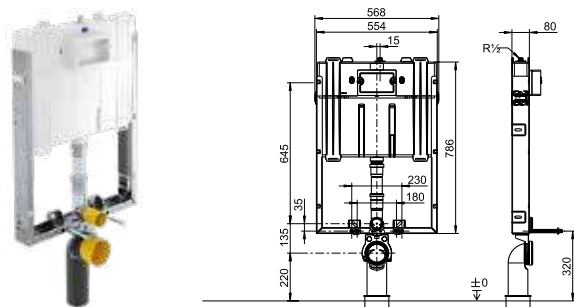
for brick-wall construction, installation depth 80 mm



Article number	Description		pcs/pal.	kg/pc.
9224 84 00	650 x 786 x 80 mm comprising a U-shaped galvanized support frame with 6 fastening lugs		20	6

for wall-mounted WC, Easy connection to flush plate via flexible cables with bayonet joint, flexible hose for filling valve, can be tightened by hand, mounting clip, 4 adjustment settings, protection box for access opening can be cut to size, Toilet connecting bend 90° DN 90 (Ø 90) / with reducing sleeve DN 90 (Ø 90) / DN 110 (Ø 110) with protection cap, Complete toilet connection set DN 90 (Ø 90) / 180 mm, with pre-assembled concealed cistern with insulation against condensation with dual flush 3/6 l, adjustable to 3/4,5 l, maximal flush quantity 7.5 l, filling valve Noise Class I, certification marks for concealed cistern: Noise Class I, M12 WC fastening materials, fastening materials, reinforcing mesh, without flush plate, individual packaging materials

Combi-pack ViConnect/O.novo: WC 5660 R0 01 + WC element, standard hight, + push-plate 9224 90, see page 264

XX = Colour code to be indicated

61 = Chrome, 68 = White, 69 = Brushed Chrome, AN = Black Matt, D8 = Anthracite Matt, LC = Stainless steel, N5 = White Matt, RA = Glass Glossy Grey, RB = Glass Glossy Black, RE = Glass Glossy White

VICONNECT INSTALLATION SYSTEMS

€ excl. VAT

WASHBASIN INSTALLATION ELEMENT

for dry-wall construction, standard height

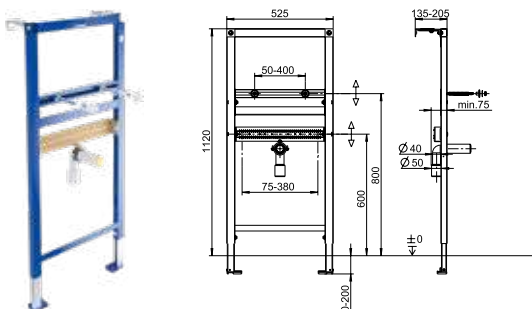



Article number	Description		pcs/ pal.	kg/ pc.
9221 49 00	525 x 1120 x 75 mm self-supporting powder-coated steel frame, fully pre-assembled		10	8,05

for covering with plasterboard, installation on a solid brick wall, in dry-wall constructions etc., adjustment range of feet from unfinished floor level to upper edge of finished floor level: 0-200mm, adjustment range front to wall: 135-205mm (when mounted on wall brackets), 4-point fastening, suitable for all washbasins and handwashbasins, with multiply bonded laminated wood panel and scaling for the free positioning of drinking water pipe wall panels, with 2 x M10 bolts for fastening washbasin, including protection plugs and washbasin fastenings, with universal waste bend DN 50 (Ø 50) / DN 40 (Ø 40) incl. rubber collar for odour trap outlet connector DN 40 (Ø 40) / DN 32 (Ø 32), protection plugs and sound-absorbing clamp, with wall brackets, with protection cap for the flushing pipe, installation instructions, incl. self-locking feet with adjustable base plates and fastening materials, individual packaging materials

BIDET INSTALLATION SYSTEM

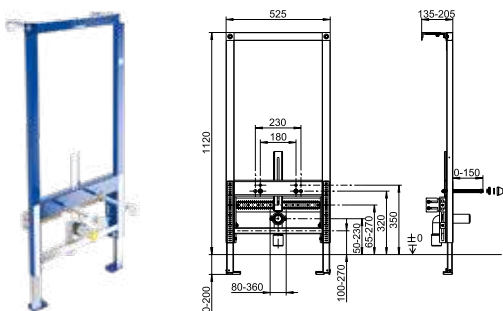
for dry-wall construction, standard height



Article number	Description		pcs/ pal.	kg/ pc.
9221 48 00	525 x 1120 x 100 mm self-supporting powder-coated steel frame, fully pre-assembled		10	10,54

for covering with plasterboard, installation on a solid brick wall, in dry-wall constructions etc., adjustment range of feet from unfinished floor level to upper edge of finished floor level: 0-200mm, adjustment range front to wall: 135-205mm (when mounted on wall brackets), 4-point fastening, universally adjustable for bidet ceramics, with multiply bonded laminated wood panel and scaling for the free positioning of drinking water pipe wall panels, with universal waste bend DN 50 (Ø 50) / DN 40 (Ø 40), incl. rubber collar DN 40 (Ø 40) / DN 32 (Ø 32) and protection plugs, with 2 x M12 retaining bolts adjustable 180/230 mm with protection plugs, nuts and white covers, with sound-absorbing clamp, with wall brackets, incl. self-locking feet with adjustable base plates and fastening materials, installation instructions, individual packaging materials

Combi-pack ViConnect/O.novo: WC 5660 R0 01 + WC element, standard hight, + push-plate 9224 90, see page 264

XX = Colour code to be indicated

61 = Chrome, 68 = White, 69 = Brushed Chrome, AN = Black Matt, D8 = Anthracite Matt, LC = Stainless steel, N5 = White Matt, RA = Glass Glossy Grey, RB = Glass Glossy Black, RE = Glass Glossy White

VICONNECT INSTALLATION SYSTEMS

€ excl. VAT

URINAL INSTALLATION SYSTEM

for dry-wall construction, standard height

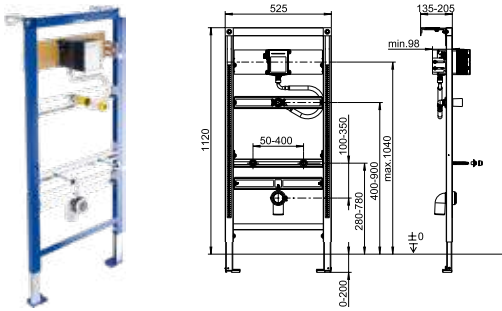

Article number	Description		pcs/ pal.	kg/ pc.
9219 89 00	525 x 1120 x 98 mm self-supporting powder-coated steel frame, fully pre-assembled			8,05

for covering with plasterboard, installation on a solid brick wall, in dry-wall constructions etc., adjustment range of feet from unfinished floor level to upper edge of finished floor level: 0-200mm, adjustment range front to wall: 135-205mm (when mounted on wall brackets), 4-point fastening, universally adjustable for urinal ceramics, with DN 50 (Ø 50) waste bend and sound-absorbing waste bend clamp, connection kit Ø 25, with flexible metal hose, which can be screwed by hand, with universal cartridge roughing-in set with modifiable water connections for cartridge valve, all crossbars pre-assembled, without urinal cover plate, with wall brackets, installation instructions, with 2 M8 bolts for fastening urinal including protection plugs and chromium-plated protection caps, incl. self-locking feet with adjustable base plates and fastening materials, individual packaging materials

URINAL INSTALLATION SYSTEM FOR PRODETECT

for dry-wall construction, standard height

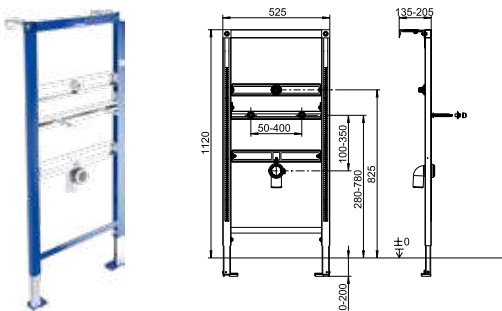

Article number	Description		pcs/ pal.	kg/ pc.
9221 85 00	525 x 1120 x 80 mm self-supporting powder-coated steel frame, fully pre-assembled		10	7,15

for covering with plasterboard, installation on a solid brick wall, in dry-wall constructions etc., adjustment range of feet from unfinished floor level to upper edge of finished floor level: 0-200mm, adjustment range front to wall: 135-205mm (when mounted on wall brackets), 4-point fastening, universally adjustable for urinal ceramics, with 1 sound-absorbing wall duct, G 1/2 IG/G 1/2 AG, with DN 50 (Ø 50) waste bend and sound-absorbing clamp, all crossbars pre-assembled, for ceramic items with integrated controls, for surface-mounted flush valve (not included in scope of delivery), for combination with ProDetect electronic urinal control by Villeroy & Boch, with wall brackets, installation instructions, without flush plate, with 2 M8 bolts for fastening urinal including protection plugs and chromium-plated protection caps, incl. self-locking feet with adjustable base plates and fastening materials, individual packaging materials

TOILET FLUSH PLATE

100S

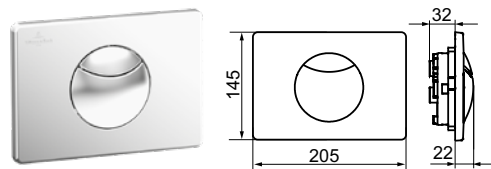

Article number	Description	61	68	69	pcs/ pal.	kg/ pc.
9224 85 XX	205 x 145 x 22 mm made of high-quality plastic				224	0,266

support frame and fastening bolts, stainless steel flush plate with securing screw, individual packaging materials

Combi-pack ViConnect/O.novo: WC 5660 R0 01 + WC element, standard height, + push-plate 9224 90, see page 264

XX = Colour code to be indicated
61 = Chrome, 68 = White, 69 = Brushed Chrome, AN = Black Matt, D8 = Anthracite Matt, LC = Stainless steel, N5 = White Matt,
RA = Glass Glossy Grey, RB = Glass Glossy Black, RE = Glass Glossy White

VICONNECT
INSTALLATION
SYSTEMS

VICONNECT INSTALLATION SYSTEMS

€ excl. VAT

URINAL FLUSH PLATE 100SU

VICONNECT
INSTALLATION
SYSTEMS

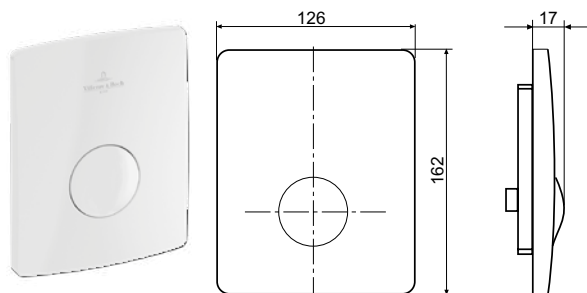

Article number	Description	61	68	69	pcs/ pal.	kg/ pc.
9219 44 XX	126 x 162 x 17 mm made of high-quality plastic, for hand-operated urinal cartridge valve technology					0,355

finished installation kit, consisting of cover plate with push button, pressure bolt, with installation frame, with pneumatic urinal cartridge valve with external thread 29 x 2 mm, with cartridge filter, operating pressure max. 10 bar, flow rate tested according to DIN EN 12541, noise class I < 20 dB (A), flushing time: 4-20 sec, infinitely adjustable, with vandal-safe special fastening of the cover plate, with fastenings, pneumatic concealed urinal flush, independent of water pressure, flow pressure min. 0.5 bar, flow pressure max. 10.0 bar, individual packaging materials

TOILET FLUSH PLATE 100M

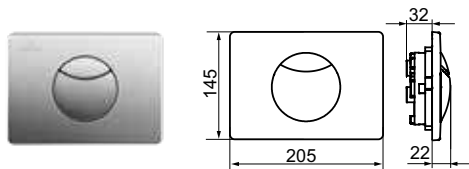

Article number	Description	LC	pcs/ pal.	kg/ pc.
9224 85 LC	205 x 145 x 22 mm made of high-quality plastic or stainless steel		224	0,27

support frame and fastening bolts, stainless steel flush plate with securing screw, individual packaging materials

TOILET FLUSH PLATE 200S

Registered design

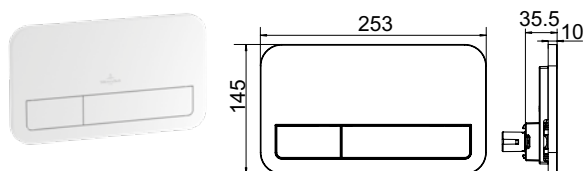

Article number	Description	61	68	69, AN	pcs/ pal.	kg/ pc.
9224 90 XX	253 x 145 x 10 mm made of high-quality plastic				224	0,361

water-saving dual flush plate, flush plate frame, support frame and fastening bolts, individual packaging materials

Combi-pack ViConnect/O.novo: WC 5660 R0 01 + WC element, standard hight, + push-plate 9224 90, see page 264

XX = Colour code to be indicated
61 = Chrome, 68 = White, 69 = Brushed Chrome, AN = Black Matt, D8 = Anthracite Matt, LC = Stainless steel, N5 = White Matt,
RA = Glass Glossy Grey, RB = Glass Glossy Black, RE = Glass Glossy White

VICONNECT INSTALLATION SYSTEMS

€ excl. VAT

TOILET FLUSH PLATE
200M ProActive+
Registered design

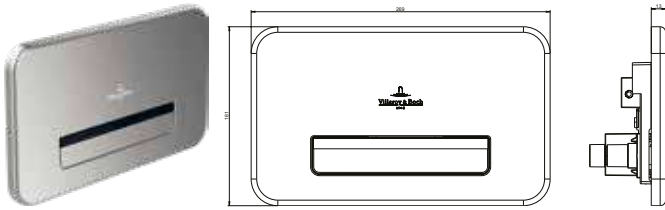

Article number	Description	NEW	LC	pcs/ pal.	kg/ pc.
9223 11 LC	269 x 161 x 13 mm electronic flush plate, Active infrared sensor-controlled toilet flushing with multi-zone sensor and time tracking, Infrared transmitter and receiver components, including interface electronics, main microcontroller, red feedback LED, motor control on the sensor board, motor unit with connection cable, cable and data interface to Bluetooth adapter (CIF control interface) and to power supply, Bluetooth module, cable and data interface to separate LED board, cable interface to 868.4 MHz receiver, polycarbonate sensor housing, PP-EPDM optical screening element, power supply unit with connection cable, optional connection of an 868.4 MHz receiver module for actuation via radio control, LED lighting of logo, colour and intensity can be adjusted, Control of functions by means of an app				0,7

individual packaging materials

TOILET FLUSH PLATE
200G ProActive+
Registered design

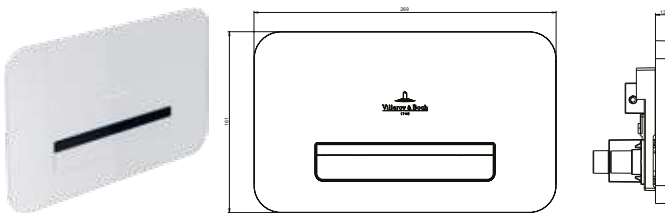

Article number	Description	NEW	RE	pcs/ pal.	kg/ pc.
9223 11 RE	269 x 161 x 13 mm electronic flush plate, Active infrared sensor-controlled toilet flushing with multi-zone sensor and time tracking, Infrared transmitter and receiver components, including interface electronics, main microcontroller, red feedback LED, motor control on the sensor board, motor unit with connection cable, cable and data interface to Bluetooth adapter (CIF control interface) and to power supply, Bluetooth module, cable and data interface to separate LED board, cable interface to 868.4 MHz receiver, polycarbonate sensor housing, PP-EPDM optical screening element, power supply unit with connection cable, optional connection of an 868.4 MHz receiver module for actuation via radio control, LED lighting of logo, colour and intensity can be adjusted, Control of functions by means of an app				0,7

individual packaging materials

TOILET FLUSH PLATE
200G
Registered design

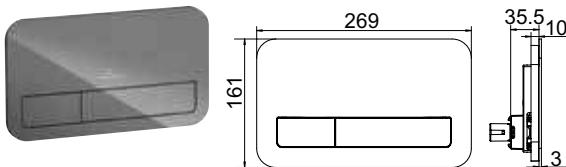

Article number	Description	RA, RB, RE	pcs/ pal.	kg/ pc.
9224 00 XX	269 x 161 x 13 mm surface made of high-quality safety glass			0,644

water-saving dual flush plate, flush plate frame, support frame and fastening bolts, individual packaging materials

Combi-pack ViConnect/O.novo: WC 5660 R0 01 + WC element, standard hight, + push-plate 9224 90, see page 264

XX = Colour code to be indicated
61 = Chrome, 68 = White, 69 = Brushed Chrome, AN = Black Matt, D8 = Anthracite Matt, LC = Stainless steel, N5 = White Matt,
RA = Glass Glossy Grey, RB = Glass Glossy Black, RE = Glass Glossy White

VICONNECT
INSTALLATION
SYSTEMS

VICONNECT INSTALLATION SYSTEMS

€ excl. VAT

TOILET FLUSH PLATE

200G LED

Registered design

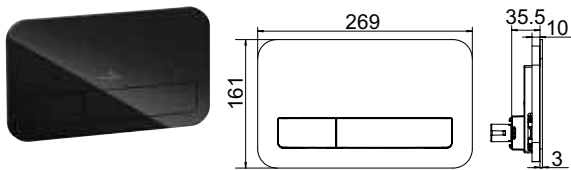

Article number	Description	RB	pcs/ pal.	kg/ pc.
9218 43 RB	269 x 161 x 13 mm surface made of high-quality safety glass with integrated LED lighting			0,981

water-saving dual flush plate, flush plate frame, support frame and fastening bolts, concealed transformer for 230V, 50 Hz, connection cable, concealed socket, conduit, individual packaging materials

TOILET FLUSH PLATE

300S

Registered design

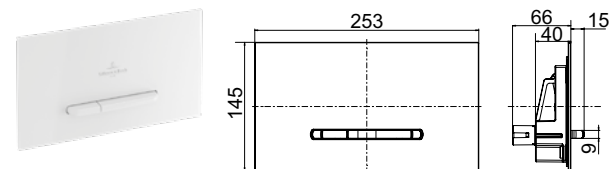

Article number	Description	61	68	69	pcs/ pal.	kg/ pc.
9221 80 XX	253 x 145 x 20 mm made of high-quality plastic				192	0,365

support frame and fastening bolts, water-saving dual flush plate, individual packaging materials

TOILET FLUSH PLATE

300S

Registered design

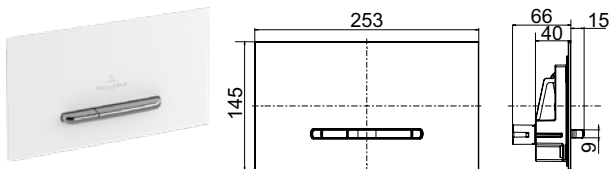

Article number	Description	68	pcs/ pal.	kg/ pc.
9221 61 XX	253 x 145 x 20 mm made of high-quality plastic, buttons in chrome			192 0,365

support frame and fastening bolts, water-saving dual flush plate, individual packaging materials

Combi-pack ViConnect/O.novo: WC 5660 R0 01 + WC element, standard hight, + push-plate 9224 90, see page 264

XX = Colour code to be indicated

61 = Chrome, 68 = White, 69 = Brushed Chrome, AN = Black Matt, D8 = Anthracite Matt, LC = Stainless steel, N5 = White Matt,

RA = Glass Glossy Grey, RB = Glass Glossy Black, RE = Glass Glossy White

VICONNECT INSTALLATION SYSTEMS

€ excl. VAT

TOILET FLUSH PLATE

300S

Registered design

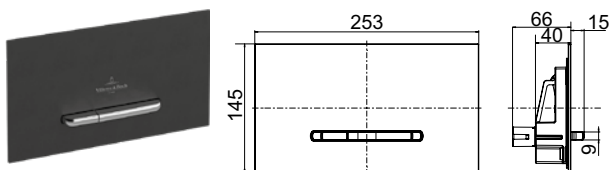

Article number	Description	AN, D8, N5	pcs/pal.	kg/pc.
9221 69 XX	253 x 145 x 20 mm made of high-quality plastic, buttons in matt chrome		192	0.365

support frame and fastening bolts, water-saving dual flush plate, individual packaging materials

TOILET FLUSH PLATE

300G

Registered design

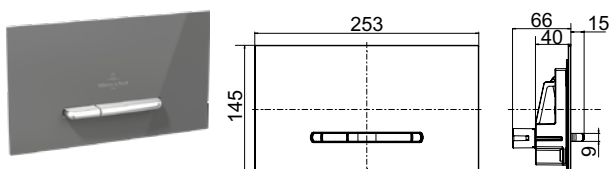

Article number	Description	RA, RB, RE	pcs/pal.	kg/pc.
9221 60 XX	253 x 145 x 20 mm surface made of high-quality safety glass, metal buttons (brushed stainless steel look)		192	0.659

support frame and fastening bolts, water-saving dual flush plate, individual packaging materials

FLUSH-MOUNTED INSTALLATION KIT

for 300S, 300G

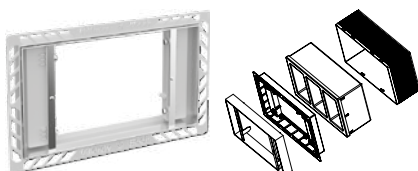

Article number	Description	LC	pcs/pal.	kg/pc.
9221 59 XX	295 x 186 x 5-25 mm visible frame (after installation) made of brushed stainless steel		75	0.682

For flush-fit installation of flush plates E300 and M300, installation kit for flush-mounted installation inc. enlarged protection plugs

DISTANCE FRAME FOR FLUSH INSTALLATION SET

for 300S, 300G

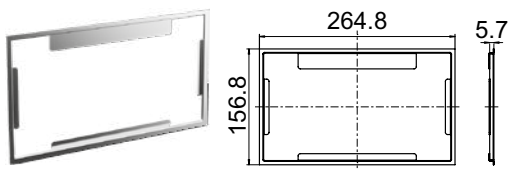

Article number	Description	LC	pcs/pal.	kg/pc.
9221 58 XX	265 x 157 x 0,7 mm frame made of brushed stainless steel			0.087

distance frame for covering uneven tile edges

Combi-pack ViConnect/O.novo: WC 5660 R0 01 + WC element, standard hight, + push-plate 9224 90, see page 264

XX = Colour code to be indicated

61 = Chrome, 68 = White, 69 = Brushed Chrome, AN = Black Matt, D8 = Anthracite Matt, LC = Stainless steel, N5 = White Matt, RA = Glass Glossy Grey, RB = Glass Glossy Black, RE = Glass Glossy White

ACCESSORIES

Sanitaryware and Bathroom Furniture

- Can be retrofitted: to match most washbasins/bidets with standard valve fit
- Flexible use thanks to separate purchasing

PRO.VILLEROY-BOCH.COM/TECHNICALDRAWINGS



Ceramic colours

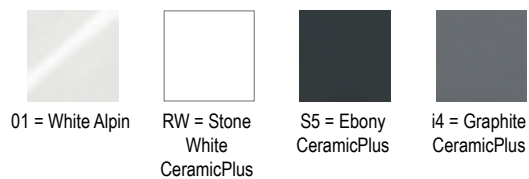

Cap colours

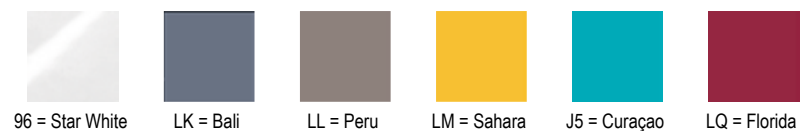

ACCESSORIES

€ excl. VAT

CAP (OVERFLOW COVER)



Article number	Description				pcs/ pal.	kg/ pc.
7901 00 XX	silicon overflow cap, to match washbasins > 500 mm wide, recommended with the washbasins in the collections: Avento, Collaro, Subway 2.0, Venticello, <i>only available in: 96, J5, LK, LL, LM, LQ</i>			-	-	0,011

PUSH-TO-OPEN VALVE



Article number	Description	01	plus RW, S5, i4		pcs/ pal.	kg/ pc.
8L03 34 XX	ceramic valve cover, to match most washbasins/bidets with standard valve fit, can be used with models with overflow function, recommended with the washbasins in the collections: Architectura, Avento, Collaro, Evana, Hommage, Loop & Friends (only for surface-mounted washbasins), Memento, Memento 2.0, Subway 2.0, Venticello			-		0,379

CLOSABLE VALVE



Article number	Description	01	plus RW, S5, i4		pcs/ pal.	kg/ pc.
6810 00 XX	flat ceramic valve cover, to match most washbasins/bidets with standard valve fit, can be used with models with overflow function, recommended with the washbasins in the collections: Antheus (only vanity washbasin), Architectura, Avento, Collaro, Evana, Hommage, Memento 2.0, Memento, Subway 2.0, Venticello			-		0,322

UNCLOSABLE OUTLET VALVE



Article number	Description	01	plus RW, S5, i4		pcs/ pal.	kg/ pc.
6808 00 XX	flat ceramic valve cover Please note: unclosable outlet valve must be used with models without overflow, to match most washbasins/bidets with standard valve fit, recommended with the washbasins in the collections: Antheus, Architectura, Artis, Avento, Collaro, Hommage, Memento, Memento 2.0, Subway 2.0, Venticello			-		0,334

XX = Colour code to be indicated

01 = White Alpin, RW = Stone White CeramicPlus, S5 = Ebony CeramicPlus, i4 = Graphite CeramicPlus

ACCESSORIES

€ excl. VAT

UNCLOSABLE OUTLET VALVE



Article number	Description				pcs/ pal.	kg/ pc.
8798 90 61	Please note: unclosable outlet valve must be used with models without overflow, chrome, recommended with the washbasins in the collections: Architectura, Artis, Avento, Aveo New Generation, Hommage, Memento, Memento 2.0, Subway 2.0, Venticello		-	-		0,38

UNCLOSABLE OUTLET VALVE



Article number	Description				pcs/ pal.	kg/ pc.
8798 50 61	Please note: unclosable outlet valve must be used with models without overflow, chrome, recommended for the washbasins in the collections: Loop & Friends (only for built-in/undercounter washbasins), Memento		-	-		0,343

EASY ACCESS SIPHON



Article number	Description				pcs/ pal.	kg/ pc.
9219 88 00	siphon with detachable odour trap and receptacle, with integrated Push Open valve, distance between ceramic underside and centre of the outlet must be between min. 115 mm and max. 160 mm, to match most washbasins with overflow function, recommended with the washbasins in the collections: Architectura, Avento, Collaro, Memento 2.0, Memento, Subway 3.0, Subway 2.0, Venticello		-	-		0,441

VIFLOW CONCEALED OVERFLOW





Article number	Description				plus	pcs/ pal.	kg/ pc.
9223 77 XX	Outlet and overflow system with ceramic valve cover, recommended for vanity washbasins without an overflow hole in the collection: Antheus, Memento 2.0, as well as selected models Collaro and Subway 3.0	01	RW	-		0,53	

XX = Colour code to be indicated

01 = White Alpin, RW = Stone White CeramicPlus, S5 = Ebony CeramicPlus, i4 = Graphite CeramicPlus

ACCESSORIES

€ excl. VAT

	DRAWER LIGHTING
	
	
Article number	FB20 00 00
Description	Drawer lighting with movement sensor and battery
For combination with	Furniture from all collections

ACCESSORIES

XX = Colour code to be indicated

WC-SEATS AND COVER

€ excl. VAT

AMADEA TOILET SEAT AND COVER

Article is only available from existing stocks. Please check availability before ordering.



Article number	Description	01	R1		pcs/ pal.	kg/ pc.
8810 61 XX	hinges in stainless steel	-	-	-	60	3,8

ARRIBA TOILET SEAT AND COVER

Article is only available from existing stocks. Please check availability before ordering.



Article number	Description	01	R1		pcs/ pal.	kg/ pc.
8826 61 01	hinges in stainless steel	-	-	-	60	3,2

AVEO NEW GENERATION TOILET SEAT AND COVER

Article is only available from existing stocks. Please check availability before ordering.



Article number	Description	01	R1		pcs/ pal.	kg/ pc.
9M57 S1 XX	with QuickRelease and SoftClosing hinges, hinges in stainless steel	-	-	-	40	3,3

BELLEVUE TOILET SEAT AND COVER

Article is only available from existing stocks. Please check availability before ordering.



Article number	Description	01	R1		pcs/ pal.	kg/ pc.
98M2 S1 R1	with QuickRelease and SoftClosing hinges, hinges in stainless steel	-	-	-	40	3,822

CENTURY TOILET SEAT AND COVER

Article is only available from existing stocks. Please check availability before ordering.



Article number	Description	01	R1		pcs/ pal.	kg/ pc.
8843 61 R1	hinges in stainless steel	-	-	-	40	3,424
8843 K1 R1	hinges in stainless steel	-	-	-		3,424

XX = Colour code to be indicated
01= White Alpin, R1 = White Alpin

WC-SEATS AND COVER

€ excl. VAT

GRANGRACIA TOILET SEAT AND COVER

Article is only available from existing stocks. Please check availability before ordering.



Article number	Description	01	R1		pcs/ pal.	kg/ pc.
8822 61 01	hinges in stainless steel		-	-	90	3,484

JOYCE TOILET SEAT AND COVER



Article number	Description	01	R1		pcs/ pal.	kg/ pc.
9M52 S1 XX	with QuickRelease and SoftClosing hinges, hinges in stainless steel		-	-	90	3,1

JOYCE TOILET SEAT AND COVER SLIMSEAT



Article number	Description	01	R1		pcs/ pal.	kg/ pc.
9M62 S1 XX	with QuickRelease and SoftClosing hinges, hinges in stainless steel		-	-	90	2,9

LA BELLE TOILET SEAT AND COVER

Article is only available from existing stocks. Please check availability before ordering.



Article number	Description	01	R1		pcs/ pal.	kg/ pc.
9M12 S1 XX	with QuickRelease and SoftClosing hinges, hinges in stainless steel	-		-	40	3,5

LIFETIME TOILET SEAT AND COVER

Article is only available from existing stocks. Please check availability before ordering.



Article number	Description	01	R1		pcs/ pal.	kg/ pc.
9M02 S1 XX	with QuickRelease and SoftClosing hinges, hinges in stainless steel		-	-	40	3,96

MEMENTO TOILET SEAT AND COVER

Article is only available from existing stocks. Please check availability before ordering.



Article number	Description	01	R1		pcs/ pal.	kg/ pc.
9M17 S1 XX	with QuickRelease and SoftClosing hinges, hinges in stainless steel	-		-	40	3,65

XX = Colour code to be indicated
 01= White Alpin, R1 = White Alpin

WC-SEATS AND COVER

€ excl. VAT

OBLIC TOILET SEAT AND COVER

Article is only available from existing stocks. Please check availability before ordering.



Article number	Description	01	R1		pcs/ pal.	kg/ pc.
8846 61 01	hinges in stainless steel		-	-	90	4

PURE STONE TOILET SEAT AND COVER

Article is only available from existing stocks. Please check availability before ordering.



Article number	Description	01	R1		pcs/ pal.	kg/ pc.
98M1 S1 R1	with QuickRelease and SoftClosing hinges, hinges in stainless steel	-		-	40	4

SENTIQUE TOILET SEAT AND COVER

Article is only available from existing stocks. Please check availability before ordering.



Article number	Description	01	R1		pcs/ pal.	kg/ pc.
98M8 S1 XX	with QuickRelease and SoftClosing hinges, hinges in stainless steel		-	-	40	4,021

XX = Colour code to be indicated
01= White Alpin, R1 = White Alpin

SHOWERS



ACRYLIC & QUARYL COLOURS

01 White Alpine



MATT COLOURS (Shower trays Planeo, Squaro, Squaro Infinity, Architectura MetalRim - Colorline & MetalRim outlet cover)



STONELOOK COLOURS (Planeo shower trays)



CERAMIC COLOURS

01 White Alpine



TP Taupe



W9 Ardoise



SUBWAY INFINITY VIPRINT DESIGNS

C0 Townhouse



C1 Abbey Grey



C2 Abbey Blue



C7 Highland Stone



C8 Nordic Creek



C9 Blue Lagoon



D0 Star Flower



D1 Sinus Black



D2 Sinus White



OUTLET COVER FOR SHOWER TRAYS

61 Chrome-plated



68 White



69 Brushed Chrome



OUTLET COVER FOR SHOWER TRAYS PLANE0

Pure Metal



Pure White



Pure Anthracite



Pure Creme



Pure Grey



Pure Sand



Pure Stone White



Anthracite



Creme



Grey



Brown



Stone White



INDEX - SHOWER TRAYS

GENERAL INFORMATION

How to use this price list	2
Wellness colour survey	8

OVERVIEWS

Shower trays according to shape and dimension	322-329
---	---------

SHOWER TRAYS (CERAMIC)

Lifetime Plus	Mainstream	330
Subway Infinity	Mainstream	331-344

SHOWER TRAYS (QUARYL®)

Futurion Flat	Mainstream	345-346
Squaro Superflat	Mainstream	347-348
Squaro Infinity	Mainstream	349-356

SHOWER TRAYS (ACRYLIC)

Architectura MetalRim	Profi	347-364
Planeo	Profi	365-371
Subway	Profi	372-373

ACCESSORIES FOR SHOWER TRAYS

ViFrame	374
---------	-----

OVERVIEW OF SHOWER TRAYS ACCORDING TO SHAPE AND DIMENSION

OVERVIEW

Rectangle, Length 800 mm

Width: 700 mm Width: 700 mm Width: 700 mm Width: 750 mm Width: 750 mm Width: 750 mm



Squaro Infinity ● Squaro Infinity ● Squaro Infinity ● Squaro Infinity ● Squaro Infinity ● Squaro Infinity ●
 UDQ8070Sqi2LV (420) UDQ8070Sqi2RV (421) UDQ8070Sqi2IV (423) UDQ8075Sqi2RV (421) UDQ8075Sqi2LV (420) UDQ8075Sqi2IV (423)

Rectangle, Length 800 mm

Width: 750 mm Width: 700 mm Width: 700 mm Width: 700 mm Width: 700 mm Width: 700 mm Width: 700 mm



Subway Infinity ○ Architectura ● Architectura ● Squaro Infinity ● Subway Infinity ○ Subway Infinity ○ Subway Infinity ○
 6229 C2 (409) UDA9070ARA215V (428) UDA9070ARA248V (432) UDQ9070Sqi2BV (422) 6229 F1 (406) 6229 H1 (409) 6229 G1 (408)

Rectangle, Length 900 mm

Width: 750 mm Width: 750 mm Width: 750 mm Width: 750 mm Width: 750 mm Width: 750 mm Width: 750 mm



Architectura ● Architectura ● Planeo ● Squaro Infinity ● Subway Infinity ○ Subway Infinity ○ Subway Infinity ○
 UDA9075ARA215V (428) UDA9075ARA248V (432) UDA9075PLA2V (442) UDQ9075Sqi2BV (422) 6229 H2 (409) 6229 G2 (408) 6229 F2 (406)

Rectangle, Length 900 mm

Width: 800 mm Width: 800 mm Width: 800 mm Width: 800 mm Width: 800 mm Width: 800 mm



Architectura ● Architectura ● Planeo ● Squaro Infinity ● Subway Infinity ○ Subway Infinity ○
 UDA9080ARA215V (428) UDA9080ARA248V (432) UDA9080PLA2V (442) UDQ9080Sqi2V (419) 6228 H3 (409) 6229 E3 (404)

Rectangle, Length 1000 mm

Width: 700 mm Width: 700 mm Width: 700 mm Width: 700 mm Width: 700 mm Width: 700 mm Width: 700 mm



Architectura ● Architectura ● Squaro Infinity ● Squaro Infinity ● Squaro Infinity ● Subway Infinity ○ Subway Infinity ○
 UDA1070ARA215V (428) UDA1070ARA248V (432) UDQ1070Sqi2IV (423) UDQ1070Sqi2LV (420) UDQ1070Sqi2RV (421) 6230 L1 (409) 6229 K1 (405)

Material

● QUARYL® ● ACRYLIC ○ CERAMIC

OVERVIEW OF SHOWER TRAYS ACCORDING TO SHAPE AND DIMENSION

OVERVIEW

Rectangle, Length 1000 mm

Width: 750 mm	Width: 750 mm	Width: 750 mm	Width: 750 mm	Width: 750 mm	Width: 750 mm	Width: 750 mm
Architectura ● UDA1075ARA248V (432)	Architectura ● UDA1075ARA215V (428)	Planeo ● UDA1075PLA2V (442)	Squaro Infinity ● UDQ1075SQI2IV (423)	Squaro Infinity ● UDQ1075SQI2RV (421)	Squaro Infinity ● UDQ1075SQI2LV (420)	Subway Infinity ○ 6230 L2 (409)

Rectangle, Length 1000 mm

Width: 750 mm	Width: 800 mm	Width: 800 mm	Width: 800 mm	Width: 800 mm	Width: 800 mm
Subway Infinity ○ 6229 K2 (405)	Architectura ● UDA1080ARA248V (432)	Architectura ● UDA1080ARA215V (428)	Futurion Flat ● UDQ1800FFL2V (414)	Lifetime Plus ○ 6223 J3 (398)	Planeo ● UDA1080PLA2V (442)

Rectangle, Length 1000 mm

Width: 800 mm	Width: 800 mm	Width: 800 mm	Width: 800 mm	Width: 900 mm	Width: 900 mm	Width: 900 mm
Squaro Infinity ● UDQ1080SQI2BV (422)	Subway ● UDA1835SUB2V (444)	Subway Infinity ○ 6229 J3 (403)	Subway Infinity ○ 6230 L3 (409)	Architectura ● UDA1090ARA215V (428)	Architectura ● UDA1090ARA248V (432)	Planeo ● UDA1090PLA2V (442)

Rectangle, Length 1000 mm

Width: 900 mm	Width: 900 mm	Width: 700 mm	Width: 700 mm	Width: 750 mm	Width: 750 mm	Width: 750 mm
Squaro Infinity ● UDQ1090SQI2V (419)	Subway Infinity ○ 6228 K4 (404)	Squaro Infinity ● UDQ1170SQI2LV (420)	Squaro Infinity ● UDQ1170SQI2RV (421)	Squaro Infinity ● UDQ1175SQI2LV (420)	Squaro Infinity ● UDQ1175SQI2IV (423)	Squaro Infinity ● UDQ1175SQI2RV (421)

Rectangle, Length 1100 mm

Width: 800 mm	Width: 800 mm	Width: 800 mm	Width: 900 mm	Width: 900 mm	Width: 900 mm	Width: 900 mm
Squaro Infinity ● UDQ1180SQI2IV (423)	Squaro Infinity ● UDQ1180SQI2RV (421)	Squaro Infinity ● UDQ1180SQI2LV (420)	Squaro Infinity ● UDQ1190SQI2IV (423)	Squaro Infinity ● UDQ1190SQI2RV (421)	Squaro Infinity ● UDQ1190SQI2LV (420)	Subway Infinity ○ 6230 M4 (404)

Material

- QUARYL®
- ACRYLIC
- CERAMIC

OVERVIEW OF SHOWER TRAYS ACCORDING TO SHAPE AND DIMENSION

OVERVIEW

Rectangle, Length 1200 mm

Width: 700 mm	Width: 700 mm	Width: 700 mm	Width: 700 mm	Width: 750 mm	Width: 750 mm	Width: 750 mm
Architectura ● UDA1270ARA215V (427)	Architectura ● UDA1270ARA248V (431)	Squaro Infinity ● UDQ1270SQI2BV (422)	Subway Infinity ○ 6231 Q1 (409)	Architectura ● UDA1275ARA215V (427)	Architectura ● UDA1275ARA248V (431)	Planeo ● UDA1275PLA2V (441)

Rectangle, Length 1200 mm

Width: 750 mm	Width: 750 mm	Width: 750 mm	Width: 800 mm	Width: 800 mm	Width: 800 mm	Width: 800 mm
Squaro Infinity ● UDQ1275SQI2BV (422)	Subway Infinity ○ 6231 Q2 (409)	Subway Infinity ○ 6230 P2 (405)	Architectura ● UDA1280ARA215V (427)	Architectura ● UDA1280ARA248V (431)	Futurion Flat ● UDQ1280FFL2V (414)	Lifetime Plus ○ 6223 N3 (398)

Rectangle, Length 1200 mm

Width: 800 mm	Width: 800 mm	Width: 800 mm	Width: 800 mm	Width: 900 mm	Width: 900 mm	Width: 900 mm
Planeo ● UDA1280PLA2V (441)	Squaro Infinity ● UDQ1280SQI2V (419)	Subway Infinity ○ 6231 Q3 (409)	Subway Infinity ○ 6230 P3 (405)	Architectura ● UDA1290ARA248V (431)	Architectura ● UDA1290ARA215V (427)	Futurion Flat ● UDQ1290FFL2V (414)

Rectangle, Length 1200 mm

Width: 900 mm	Width: 900 mm	Width: 900 mm	Width: 900 mm	Width: 900 mm	Width: 900 mm
Lifetime Plus ○ 6223 N4 (398)	Planeo ● UDA1290PLA2V (441)	Squaro ● UDQ1290SQR2V (416)	Squaro Infinity ● UDQ1290SQI2V (419)	Subway ● UDA1293SUB2V (444)	Subway Infinity ○ 6230 N4 (403)

Rectangle, Length 1200 mm

Width: 900 mm	Width: 700 mm	Width: 700 mm	Width: 700 mm	Width: 750 mm	Width: 750 mm	Width: 750 mm
Subway Infinity ○ 6232 N4 (409)	Squaro Infinity ● UDQ1370SQI2LV (420)	Squaro Infinity ● UDQ1370SQI2RV (421)	Squaro Infinity ● UDQ1370SQI2IV (423)	Squaro Infinity ● UDQ1375SQI2LV (420)	Squaro Infinity ● UDQ1375SQI2RV (421)	Squaro Infinity ● UDQ1375SQI2IV (423)

Rectangle, Length 1300 mm

Material
 ● QUARYL® ● ACRYLIC ○ CERAMIC

OVERVIEW OF SHOWER TRAYS ACCORDING TO SHAPE AND DIMENSION

OVERVIEW

Rectangle, Length 1300 mm

Width: 800 mm	Width: 800 mm	Width: 800 mm	Width: 900 mm	Width: 900 mm	Width: 900 mm	Width: 900 mm
Squaro Infinity ● UDQ1380SQI2IV (423)	Squaro Infinity ● UDQ1380SQI2RV (421)	Squaro Infinity ● UDQ1380SQI2LV (420)	Squaro Infinity ● UDQ1390SQI2IV (423)	Squaro Infinity ● UDQ1390SQI2RV (421)	Squaro Infinity ● UDQ1390SQI2LV (420)	Subway Infinity ○ 6231 R4 (404)

Rectangle, Length 1400 mm

Width: 700 mm	Width: 700 mm	Width: 700 mm	Width: 750 mm	Width: 750 mm	Width: 750 mm	Width: 750 mm
Architectura ● UDA1470ARA248V (431)	Architectura ● UDA1470ARA215V (427)	Squaro Infinity ● UDQ1470SQI2BV (422)	Architectura ● UDA1475ARA248V (431)	Architectura ● UDA1475ARA215V (427)	Planeo ● UDA1475PLA2V (441)	Squaro Infinity ● UDQ1475SQI2BV (422)

Rectangle, Length 1400 mm

Width: 750 mm	Width: 750 mm	Width: 800 mm	Width: 800 mm	Width: 800 mm	Width: 800 mm	Width: 800 mm
Subway Infinity ○ 6231 T2 (405)	Subway Infinity ○ 6232 V2 (409)	Architectura ● UDA1480ARA248V (431)	Architectura ● UDA1480ARA215V (427)	Lifetime Plus ○ 6223 S3 (398)	Planeo ● UDA1480PLA2V (441)	Squaro Infinity ● UDQ1480SQI2V (419)

Rectangle, Length 1400 mm

Width: 800 mm	Width: 800 mm	Width: 900 mm	Width: 900 mm	Width: 900 mm	Width: 900 mm	Width: 900 mm
Subway Infinity ○ 6232 V3 (409)	Subway Infinity ○ 6231 T3 (405)	Architectura ● UDA1490ARA248V (431)	Architectura ● UDA1490ARA215V (427)	Furion Flat ● UDQ1490FFL2V (414)	Lifetime Plus ○ 6223 S4 (398)	Planeo ● UDA1490PLA2V (441)

Rectangle, Length 1400 mm

Width: 900 mm	Width: 900 mm	Width: 900 mm	Width: 900 mm	Width: 900 mm	Width: 1000 mm	Width: 1000 mm
Squaro ● UDQ1490SQR2V (415)	Squaro Infinity ● UDQ1490SQI2V (419)	Subway ● UDA1493SUB2V (444)	Subway Infinity ○ 6232 V4 (409)	Subway Infinity ○ 6231 S4 (403)	Planeo ● UDA1410PLA2V (441)	Squaro Infinity ● UDQ1410SQI2IV (423)

Material

- QUARYL®
- ACRYLIC
- CERAMIC

OVERVIEW OF SHOWER TRAYS ACCORDING TO SHAPE AND DIMENSION

OVERVIEW

Rectangle, Length 1500 mm

Width: 700 mm	Width: 700 mm	Width: 700 mm	Width: 750 mm	Width: 750 mm	Width: 750 mm	Width: 750 mm
Squaro Infinity ● UDQ1570SQI2LV (420)	Squaro Infinity ● UDQ1570SQI2RV (421)	Squaro Infinity ● UDQ1570SQI2IV (423)	Squaro Infinity ● UDQ1575SQI2LV (420)	Squaro Infinity ● UDQ1575SQI2RV (421)	Squaro Infinity ● UDQ1575SQI2IV (423)	Subway Infinity ○ 6232 32 (409)

Rectangle, Length 1500 mm

Width: 800 mm	Width: 800 mm	Width: 800 mm	Width: 800 mm	Width: 800 mm	Width: 800 mm	Width: 800 mm
Architectura ● UDA1580ARA215V (427)	Architectura ● UDA1580ARA248V (431)	Planeo ● UDA1580PLA2V (440)	Squaro Infinity ● UDQ1580SQI2IV (423)	Squaro Infinity ● UDQ1580SQI2RV (421)	Squaro Infinity ● UDQ1580SQI2LV (420)	Subway Infinity ○ 6232 33 (409)

Rectangle, Length 1500 mm

Width: 900 mm	Width: 900 mm	Width: 900 mm	Width: 900 mm	Width: 900 mm	Width: 900 mm	Width: 900 mm
Architectura ● UDA1590ARA248V (431)	Architectura ● UDA1590ARA215V (427)	Planeo ● UDA1590PLA2V (440)	Squaro Infinity ● UDQ1590SQI2IV (423)	Squaro Infinity ● UDQ1590SQI2RV (421)	Squaro Infinity ● UDQ1590SQI2LV (420)	Subway Infinity ○ 6232 34 (409)

Rectangle, Length 1500 mm

Width: 900 mm	Width: 900 mm	Width: 1000 mm	Width: 1000 mm	Width: 1000 mm	Width: 1000 mm	Width: 1000 mm
Subway Infinity ○ 6232 24 (408)	Subway Infinity ○ 6232 14 (406)	Architectura ● UDA1510ARA215V (427)	Architectura ● UDA1510ARA248V (431)	Planeo ● UDA1510PLA2V (440)	Squaro Infinity ● UDQ1510SQI2IV (423)	Subway Infinity ○ 6232 W5 (404)

Rectangle, Length 1600 mm

Width: 700 mm	Width: 700 mm	Width: 700 mm	Width: 750 mm	Width: 750 mm	Width: 750 mm	Width: 800 mm
Architectura ● UDA1670ARA215V (426)	Architectura ● UDA1670ARA248V (430)	Squaro Infinity ● UDQ1670SQI2BV (422)	Architectura ● UDA1675ARA215V (426)	Architectura ● UDA1675ARA248V (430)	Squaro Infinity ● UDQ1675SQI2BV (422)	Architectura ● UDA1680ARA215V (426)

Material

- QUARYL®
- ACRYLIC
- CERAMIC

OVERVIEW OF SHOWER TRAYS ACCORDING TO SHAPE AND DIMENSION

OVERVIEW

Rectangle, Length 1600 mm

Width: 800 mm	Width: 800 mm	Width: 800 mm	Width: 900 mm	Width: 900 mm	Width: 900 mm	Width: 900 mm
Architecture ● UDA1680ARA248V (430)	Planeo ● UDA1680PLA2V (440)	Squaro Infinity ● UDQ1680SQI2V (419)	Architecture ● UDA1690ARA248V (430)	Architecture ● UDA1690ARA215V (426)	Futurion Flat ● UDQ1690FFL2V (414)	Planeo ● UDA1690PLA2V (440)

Rectangle, Length 1600 mm

Width: 900 mm	Width: 900 mm	Width: 900 mm	Width: 900 mm	Width: 1000 mm	Width: 1000 mm	Width: 1000 mm
Squaro ● UDQ1690SQR2V (415)	Squaro Infinity ● UDQ1690SQI2V (419)	Subway ● UDA1693SUB2V (444)	Subway Infinity ○ 6232 54 (405)	Planeo ● UDA1610PLA2V (440)	Squaro Infinity ● UDQ1610SQI2RV (421)	Squaro Infinity ● UDQ1610SQI2LV (420)

Rectangle, Length 1600 mm

Width: 1000 mm	Width: 1000 mm	Width: 700 mm	Width: 700 mm	Width: 700 mm	Width: 700 mm	Width: 700 mm
Squaro Infinity ● UDQ1610SQI2IV (423)	Subway Infinity ○ 6232 45 (403)	Architecture ● UDA1770ARA215V (426)	Architecture ● UDA1770ARA248V (430)	Squaro Infinity ● UDQ1770SQI2LV (420)	Squaro Infinity ● UDQ1770SQI2RV (421)	Squaro Infinity ● UDQ1770SQI2IV (423)

Rectangle, Length 1700 mm

Width: 750 mm	Width: 750 mm	Width: 750 mm	Width: 750 mm	Width: 750 mm	Width: 800 mm	Width: 800 mm
Architecture ● UDA1775ARA248V (430)	Architecture ● UDA1775ARA215V (426)	Squaro Infinity ● UDQ1775SQI2IV (423)	Squaro Infinity ● UDQ1775SQI2RV (421)	Squaro Infinity ● UDQ1775SQI2LV (420)	Architecture ● UDA1780ARA215V (426)	Architecture ● UDA1780ARA248V (430)

Rectangle, Length 1700 mm

Width: 800 mm	Width: 800 mm	Width: 800 mm	Width: 800 mm	Width: 800 mm	Width: 900 mm	Width: 900 mm
Planeo ● UDA1780PLA2V (439)	Squaro ● UDQ1780SQR2V (415)	Squaro Infinity ● UDQ1780SQI2IV (423)	Squaro Infinity ● UDQ1780SQI2LV (420)	Squaro Infinity ● UDQ1780SQI2RV (421)	Architecture ● UDA1790ARA215V (426)	Architecture ● UDA1790ARA248V (430)

Material

- QUARYL®
- ACRYLIC
- CERAMIC

OVERVIEW OF SHOWER TRAYS ACCORDING TO SHAPE AND DIMENSION

OVERVIEW

Rectangle, Length 1700 mm

Width: 900 mm	Width: 900 mm	Width: 900 mm	Width: 900 mm	Width: 1000 mm	Width: 1000 mm	Width: 1000 mm
Planeo ● UDA1790PLA2V (439)	Squaro Infinity ● UDQ1790SQI2IV (423)	Squaro Infinity ● UDQ1790SQI2LV (420)	Squaro Infinity ● UDQ1790SQI2RV (421)	Squaro Infinity ● UDQ1710SQI2RV (421)	Squaro Infinity ● UDQ1710SQI2IV (423)	Squaro Infinity ● UDQ1710SQI2LV (420)

Rectangle, Length 1800 mm

Width: 700 mm	Width: 750 mm	Width: 800 mm	Width: 800 mm	Width: 800 mm	Width: 800 mm	Width: 900 mm
Squaro Infinity ● UDQ1870SQI2BV (422)	Squaro Infinity ● UDQ1875SQI2BV (422)	Architectura ● UDA1880ARA215V (426)	Architectura ● UDA1880ARA248V (430)	Planeo ● UDA1880PLA2V (439)	Squaro Infinity ● UDQ1880SQI2V (419)	Architectura ● UDA1890ARA215V (426)

Rectangle, Length 1800 mm

Width: 900 mm	Width: 900 mm	Width: 900 mm	Width: 900 mm	Width: 900 mm	Width: 900 mm	Width: 1000 mm
Architectura ● UDA1890ARA248V (430)	Furion Flat ● UDQ1890FFL2V (414)	Planeo ● UDA1890PLA2V (439)	Squaro ● UDQ1890SQR2V (415)	Squaro Infinity ● UDQ1890SQI2BV (422)	Subway ● UDA1893SUB2V (444)	Planeo ● UDA1810PLA2V (439)

Rectangle, Length 1800 mm Square, Length 800 mm

Width: 1000 mm	Width: 800 mm	Width: 800 mm	Width: 800 mm	Width: 800 mm	Width: 800 mm
Squaro Infinity ● UDQ1810SQI2V (419)	Architectura ● UDA8080ARA115V (425)	Architectura ● UDA8080ARA148V (429)	Lifetime Plus ○ 6223 B3 (398)	Planeo ● UDA8080PLA1V (438)	Squaro Infinity ● UDQ8080SQI1RV (421)

Square, Length 800 mm

Width: 800 mm	Width: 800 mm	Width: 800 mm
Squaro Infinity ● UDQ8080SQI1LV (420)	Squaro Infinity ● UDQ8080SQI1V (423)	Subway Infinity ○ 6228 C3 (409)

Square, Length 900 mm

Width: 900 mm	Width: 900 mm	Width: 900 mm	Width: 900 mm
Architectura ● UDA9090ARA148V (429)	Architectura ● UDA9090ARA115V (425)	Furion Flat ● UDQ0900FFL1V (413)	Lifetime Plus ○ 6223 D4 (398)

Material

- QUARYL®
- ACRYLIC
- CERAMIC

OVERVIEW OF SHOWER TRAYS ACCORDING TO SHAPE AND DIMENSION

Square, Length 900 mm

Width: 900 mm

Width: 900 mm

Width: 900 mm

Width: 900 mm

Width: 900 mm

Width: 900 mm

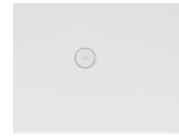
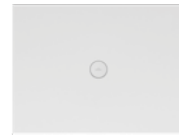

Planeo ●

Squaro ●

Squaro Infinity ●

Subway ●

Subway Infinity ○

Subway Infinity ○

UDA9090PLA1V (438)

UDQ0910SQR1V (415)

UDQ9090SQI1V (419)

UDA0935SUB1V (443)

6228 H4 (409)

6228 F4 (407)

Square, Length 1000 mm

Width: 1000 mm

Width: 1000 mm

Width: 1000 mm

Width: 1000 mm

Width: 1000 mm

Width: 1000 mm



Architectura ●

Architectura ●

Lifetime Plus ○

Planeo ●

Squaro ●

Squaro Infinity ●

UDA1010ARA115V (425)

UDA1010ARA148V (429)

6223 J5 (398)

UDA1010PLA1V (438)

UDQ1010SQR1V (415)

UDQ1010SQI1V (419)

Square, Length 1000 mm

Width: 1000 mm

Width: 1000 mm

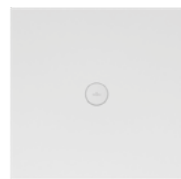

Subway ●

Subway Infinity ○

UDA1035SUB1V (443)

6228 J5 (403)

Material

● QUARYL®

● ACRYLIC

○ CERAMIC

LIFETIME PLUS (Rectangle), Ceramic

€ excl. VAT

Technical information:

Ceramic available in White Alpin (01) with anti-slip class B (PN18), Taupe (TP) and Ardoise (W9) with anti-slip class A (PN12).
 Extra-flat design for surface-mounting or flush-fit installation.
 4 sides glazed
 The installation height of the shower can be reduced by 30mm if outlet fitting 9226 00 XX is used.
 Please note: this outlet fitting does not conform to EN 274.

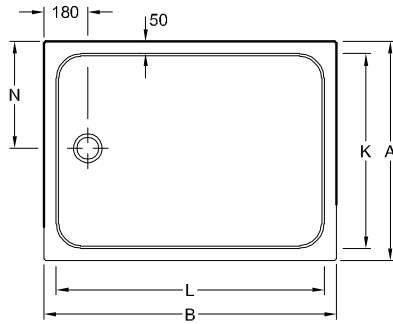

Article no.	A	B	K	L	N	T
6223 S4 XX	900	1400	800	1300	450	18
6223 S3 XX	800	1400	700	1300	400	18
6223 N4 XX	900	1200	800	1100	450	18
6223 N3 XX	800	1200	700	1100	400	18
6223 J3 XX	800	1000	700	900	400	18

Article number	Size l x w x h	Weight (kg)	Waste ø	01	TP, W9	pcs/pal.
6223 S4 XX	1400 x 900 x 35 mm	49,45	90			10
6223 S3 XX	1400 x 800 x 35 mm	41,65				10
6223 N4 XX	1200 x 900 x 35 mm	37,2				10
6223 N3 XX	1200 x 800 x 35 mm	34,7				10
6223 J3 XX	1000 x 800 x 35 mm	30,3				10

Accessories for shower trays

Article number	Description	61, 68, 69
9225 00 XX	Tempoplex Plus outlet Ø 90mm (on request) (please specify colour for the included outlet cover)	
9226 00 XX	Tempoplex Plus outlet Compact Ø 90mm (on request) (please specify colour for the included outlet cover)	
9226 02 XX	Spare outlet cover (on request)	

LIFETIME PLUS (Square), Ceramic

Technical information:

Ceramic available in White Alpin (01) with anti-slip class B (PN18), Taupe (TP) and Ardoise (W9) with anti-slip class A (PN12).
 Extra-flat design for surface-mounting or flush-fit installation.
 4 sides glazed
 The installation height of the shower can be reduced by 30mm if outlet fitting 9226 00 XX is used.
 Please note: this outlet fitting does not conform to EN 274.

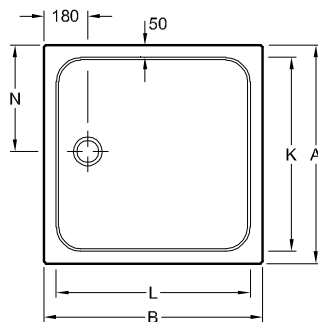

Article no.	A	B	K	L	N	T
6223 J5 XX	1000	1000	900	900	500	18
6223 D4 XX	900	900	700	700	450	18
6223 B3 XX	800	800	700	700	400	18

Article number	Size l x w x h	Weight (kg)	Waste ø	01	TP, W9	pcs/pal.
6223 J5 XX	1000 x 1000 x 35 mm	39,5	90			10
6223 D4 XX	900 x 900 x 35 mm	28,6				10
6223 B3 XX	800 x 800 x 35 mm	23,05				10

Accessories for shower trays

Article number	Description	61, 68, 69
9225 00 XX	Tempoplex Plus outlet Ø 90mm (on request) (please specify colour for the included outlet cover)	
9226 00 XX	Tempoplex Plus outlet Compact Ø 90mm (on request) (please specify colour for the included outlet cover)	
9226 02 XX	Spare outlet cover (on request)	

XX = Colour code to be indicated
 For further information on colours, please see the page at the beginning of this section.

SUBWAY INFINITY



€ excl. VAT

Subway Infinity is the ceramic shower tray from Villeroy & Boch that is simply cut to size for greater scope in colour and form. Three different installation methods also allow for extremely flexible installation.

Greater design freedom

- 43 models from 1600 x 1000 to 800 x 750 mm plus further sizes and special shapes that can be cut to size as required
- Ultra-flat look, 40 mm rim height

Easy and safe to install

- Three different installation methods: flush-fit installation, installation on tiles, installation on a base
- Sopro sealing system available
- ViFrame installation frame available for all shower tray sizes

Antislip - for maximum safety

- The anti-slip effect on ceramic shower trays is not a surface coating but the result of particles in the glaze. This achieves long-lasting slip resistance and facilitates cleaning.
- All sizes are available in White Alpine with anti-slip class B (PN18), or in Taupe and Ardoise with anti-slip class A (PN12).



Colours ceramic shower trays

Colours with anti-slip finish

Anti-slip class PN18

Anti-slip class PN12

Anti-slip class PN12

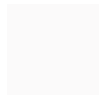

01 White Alpine



W9 Ardoise



TP Taupe

Colours of outlet covers



61 Chrome-plated



68 White



69 Brushed Chrome

SUBWAY INFINITY

€ excl. VAT

ViPrint Designs



ViPrint is an innovative technology that is used to print the Subway Infinity shower trays with impressive design décors. ViPrint combines the design possibilities of tiled showers with simple cleaning of the seamless shower-tray surface.



Fascinating designs

- 9 stylish décors inspired by the three styles "Nature", "Heritage" and "Geometry"
- Wide range of design options – both for coordinating with the colours in the room or as a colour contrast to wall and floor tiles.

High quality and safety

- Permanently colour-fast and durable as décors are part of the glaze
- Very easy to clean
- All sizes with ViPrint décors are available with anti-slip class A (PN12).

ViPrint décors slip-resistance class A (PN12)

Technical information

Shower trays with ViPrint are available in cut and uncut form. The uncut shower trays have a glazed edge in a pre-defined colour (see colour shown next to décor). Cut sides must be set against the wall or integrated within the floor surface. Orders that we have confirmed for custom-made shower trays cannot be cancelled or altered.

Inspired by Heritage



C0 Townhouse



Light Grey



C1 Abbey Grey



Light Grey



C2 Abbey Blue



Light Grey

Inspired by Nature



C7 Highland Stone



TP Taupe



C8 Nordic Creek



Light Grey



C9 Blue Lagoon



Light Grey

Inspired by Geometry



D0 Star Flower



White Alpin

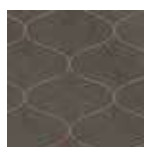

D1 Sinus Black



Light Grey



D2 Sinus White



White Alpin

SUBWAY INFINITY

€ excl. VAT

ViPrint Designs

Article numbers

For ViPrint décors, the colour code is indicated via the 9th and 10th digit in the article number, see example:

Article number	ViPrint code	Colour code
6232 34	VP	A1

For further information on ViPrint décors please visit our website:
PRO.VILLEROY-BOCH.COM/VIPRINT



Download the Augmented Reality
 app now and experience ViPrint
 virtually:
villeroyboch.com/ar



SUBWAY INFINITY AND VIPRINT

€ excl. VAT

How do I order?

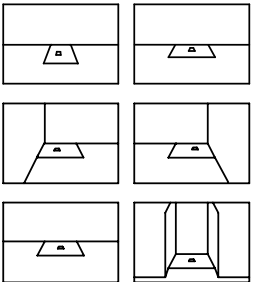
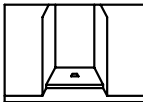
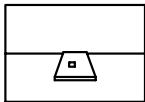
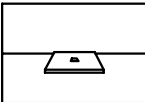
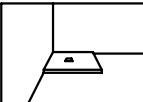
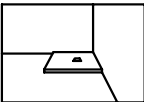
Length	Width	Flush-fitting installation	Resting installation				
		Page 409	Page 403, 404, 405, 406, 407, 408	Page 403, 404	Page 403, 405	Page 403, 407, 406, 405, 404	Page 403, 408, 407, 405, 404
							
800	750	○	-	-	-	-	-
	800	○	-	-	-	-	-
900	700	○	○	-	-	○	○
	750	○	○	-	-	○	○
	800	○	○	○	-	○	○
	900	○	○	-	-	○	○
1000	700	○	○	-	○	○	○
	750	○	○	-	○	○	○
	800	○	○	○	○	○	○
	900	○	○	○	-	○	○
	1000	○	○	○	○	○	○
1100	900	○	○	○	-	○	○
1200	700	○	-	-	-	-	-
	750	○	○	-	○	○	○
	800	○	○	-	○	○	○
	900	○	○	○	○	○	○
1300	900	○	○	○	-	○	○
1400	750	○	○	-	○	○	○
	800	○	○	-	○	○	○
	900	○	○	○	○	○	○
1500	750	○	-	-	-	-	-
	800	○	-	-	-	-	-
	900	○	○	-	-	○	○
	1000	○	○	○	-	○	○
1600	900	○	○	-	○	○	○
	1000	○	○	○	○	○	○

For other dimensions see page 410.

Special shapes see order form or page 411-412.

The symbol "o" means: this size is possible.

SHOWER TRAYS

SUBWAY INFINITY standard models for all installation types (Rectangle), Ceramic

€ excl. VAT

Technical information:

Ceramic available in White Alpin (01) with anti-slip class B (PN18), Taupe (TP), Ardoise (W9) and ViPrint décors with anti-slip class A (PN12).
 4 sides glazed
These shower trays are not cut and can be used for all installation types (recommended: ViFrame installation system)
 The installation height of the shower can be reduced by 30mm if outlet fitting 9226 00 XX is used.
 Please note: this outlet fitting does not conform to EN 274.
 Shower tray, stepless access

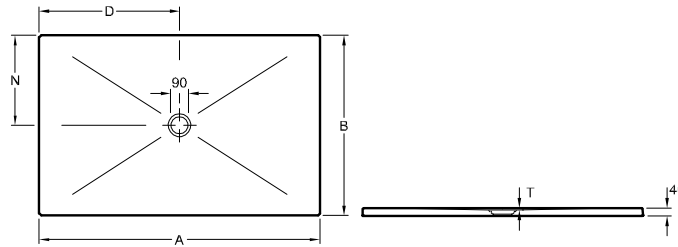
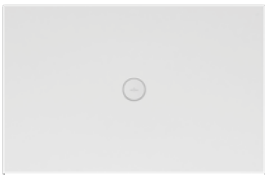

Article no.	A	B	D	N	T
6232 45 XX	1600	1000	800	500	12
6231 S4 XX	1400	900	700	450	12
6230 N4 XX	1200	900	600	450	12
6229 J3 XX	1000	800	500	400	12
6228 J5 XX	1000	1000	500	500	12

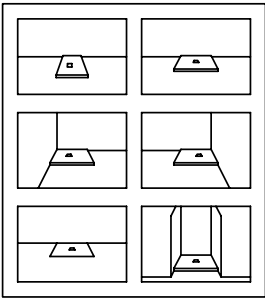

Article number	Size l x w x h	Weight (kg)	Waste ø	01	TP, W9	VPXX	pcs/ pal.
6232 45 XX	1600 x 1000 x 40 mm	63,5	90				10
6231 S4 XX	1400 x 900 x 40 mm	52,8					10
6230 N4 XX	1200 x 900 x 40 mm	42,95					10
6229 J3 XX	1000 x 800 x 40 mm	34,1					10
6228 J5 XX	1000 x 1000 x 40 mm	40,85					10

Accessories for shower trays

Article number	Description	61, 68, 69
9225 00 XX	Tempoplex Plus outlet Ø 90mm (required accessory) (please specify colour for the included outlet cover)	
9226 00 XX	Tempoplex Plus outlet Compact Ø 90mm (required accessory) (please specify colour for the included outlet cover)	
9226 02 XX	Spare outlet cover (on request)	
U9141 21 00	ViFrame installation frame, for smaller shower trays (up to 1000 x 1000 mm) made of ceramic or acrylic, incl. 2 central feet (on request)	
U9141 22 00	ViFrame installation frame, for larger shower trays (from 1000 x 1000 mm) made of ceramic or acrylic, incl. 4 central feet (on request)	

XX = Colour code to be indicated
 For further information on colours, please see the page at the beginning of this section.

SHOWER TRAYS

SUBWAY INFINITY short side cut against wall, for all installation types (Rectangle), Ceramic

€ excl. VAT

Technical information:

Ceramic available in White Alpin (01) with anti-slip class B (PN18), Taupe (TP), Ardoise (W9) and ViPrint décors with anti-slip class A (PN12).
These shower trays are cut along the short side (unglazed) and have to be installed with the unglazed side against the wall.
 Total price includes the surcharge for cutting!
 Please note: the outlet is positioned asymmetrically, not centrally!
 The installation height of the shower can be reduced by 30mm if outlet fitting 9226 00 XX is used.
 Please note: this outlet fitting does not conform to EN 274.
 *Shower trays marked with an asterisk can only be installed with ViFrame installation system or in a mortar bed.
 Shower tray, stepless access

SHOWER TRAYS

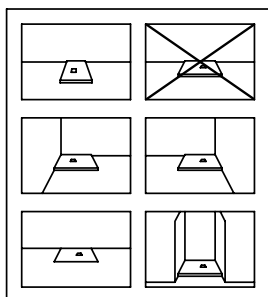
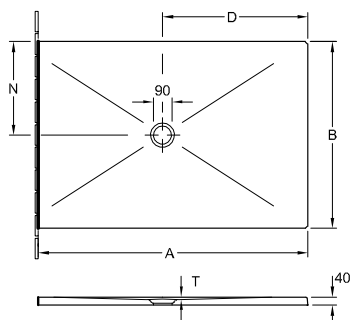
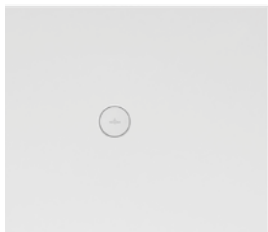

Article no.	A	B	D	N	T
6232 W5 XX*	1500	1000	800	500	12
6231 R4 XX	1300	900	700	450	12
6230 M4 XX	1100	900	600	450	12
6228 K4 XX	900	1000	500	500	12
6229 E3 XX	900	800	500	400	12

Article number	Size l x w x h	Weight (kg)	Waste ø	01	TP, W9	VPXX	pcs/ pal.
6232 W5 XX*	1500 x 1000 x 40 mm	63,75	90				10
6231 R4 XX	1300 x 900 x 40 mm	49,21					10
6230 M4 XX	1100 x 900 x 40 mm	41,25					10
6228 K4 XX	1000 x 900 x 40 mm	39,1					10
6229 E3 XX	900 x 800 x 40 mm	29,7					10

Accessories for shower trays

Article number	Description	61, 68, 69
9225 00 XX	Tempoplex Plus outlet Ø 90mm (required accessory) (please specify colour for the included outlet cover)	
9226 00 XX	Tempoplex Plus outlet Compact Ø 90mm (required accessory) (please specify colour for the included outlet cover)	
9226 02 XX	Spare outlet cover (on request)	
U9141 21 00	ViFrame installation frame, for smaller shower trays (up to 1000 x 1000 mm) made of ceramic or acrylic, incl. 2 central feet (on request)	
U9141 22 00	ViFrame installation frame, for larger shower trays (from 1000 x 1000 mm) made of ceramic or acrylic, incl. 4 central feet (on request)	

XX = Colour code to be indicated
 For further information on colours, please see the page at the beginning of this section.

SUBWAY INFINITY long side cut against wall, for all installation types (Rectangle), Ceramic

€ excl. VAT

Technical information:

Ceramic available in White Alpin (01) with anti-slip class B (PN18), Taupe (TP), Ardoise (W9) and ViPrint décors with anti-slip class A (PN12).
These shower trays are cut along the long side (unglazed) and have to be installed with the unglazed side against the wall.
 Total price includes the surcharge for cutting!
 Please note: the outlet is positioned asymmetrically, not centrally!
 The installation height of the shower can be reduced by 30mm if outlet fitting 9226 00 XX is used.
 Please note: this outlet fitting does not conform to EN 274.
 *Shower trays marked with an asterisk can only be installed with ViFrame installation system or in a mortar bed.
 Shower tray, stepless access

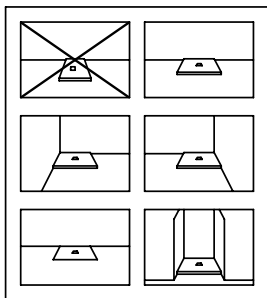
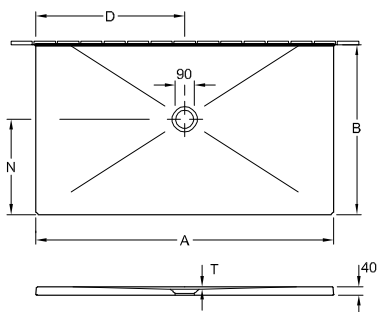
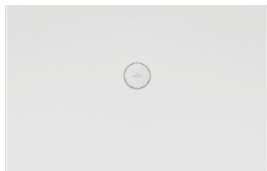

Article no.	A	B	D	N	T
6232 54 XX*	1600	900	800	500	12
6231 T3 XX	1400	800	700	450	12
6231 T2 XX	1400	750	700	450	12
6230 P3 XX	1200	800	600	450	12
6230 P2 XX	1200	750	600	450	12
6229 K2 XX	1000	750	500	400	12
6229 K1 XX	1000	700	500	400	12

SHOWER TRAYS

Article number	Size l x w x h	Weight (kg)	Waste ø	01	TP, W9	VPXX	pcs/pal.
6232 54 XX*	1600 x 900 x 40 mm	61,2	90				10
6231 T3 XX	1400 x 800 x 40 mm	47,11					10
6231 T2 XX	1400 x 750 x 40 mm	44,17					10
6230 P3 XX	1200 x 800 x 40 mm	40					10
6230 P2 XX	1200 x 750 x 40 mm	37,5					10
6229 K2 XX	1000 x 750 x 40 mm	30,94					10
6229 K1 XX	1000 x 700 x 40 mm	28,88					10

Accessories for shower trays

Article number	Description	61, 68, 69
9225 00 XX	Tempoplex Plus outlet Ø 90mm (required accessory) (please specify colour for the included outlet cover)	
9226 00 XX	Tempoplex Plus outlet Compact Ø 90mm (required accessory) (please specify colour for the included outlet cover)	
9226 02 XX	Spare outlet cover (on request)	
U9141 21 00	ViFrame installation frame, for smaller shower trays (up to 1000 x 1000 mm) made of ceramic or acrylic, incl. 2 central feet (on request)	
U9141 22 00	ViFrame installation frame, for larger shower trays (from 1000 x 1000 mm) made of ceramic or acrylic, incl. 4 central feet (on request)	

XX = Colour code to be indicated
 For further information on colours, please see the page at the beginning of this section.

SUBWAY INFINITY corner installation, left against the wall (Rectangle), Ceramic

€ excl. VAT

Technical information:

Ceramic available in White Alpin (01) with anti-slip class B (PN18), Taupe (TP), Ardoise (W9) and ViPrint décors with anti-slip class A (PN12).
These shower trays are cut along 2 sides (unglazed) and have to be installed on left against the wall
 Total price includes the surcharge for cutting!
 Please note: the outlet is positioned asymmetrically, not centrally!
 The installation height of the shower can be reduced by 30mm if outlet fitting 9226 00 XX is used.
 Please note: this outlet fitting does not conform to EN 274.
 *Shower trays marked with an asterisk can only be installed with ViFrame installation system or in a mortar bed.
 Shower tray, stepless access

SHOWER TRAYS

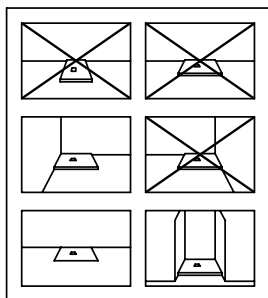
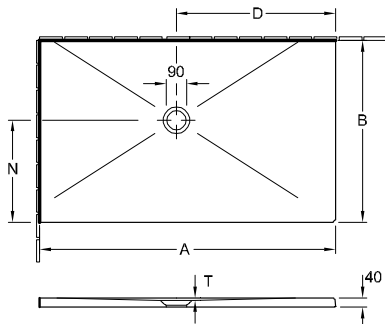
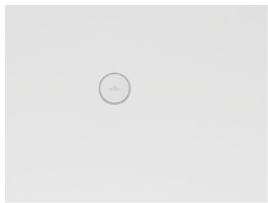

Article no.	A	B	D	N	T
6232 14 XX*	1500	900	800	500	12
6229 F2 XX	900	750	500	400	12
6229 F1 XX	900	700	500	400	12

Article number	Size l x w x h	Weight (kg)	Waste ø	01	TP, W9	VPXX	pcs/pal.
6232 14 XX*	1500 x 900 x 40 mm	57,38	90				10
6229 F2 XX	900 x 750 x 40 mm	27,84					10
6229 F1 XX	900 x 700 x 40 mm	25,99					10

Accessories for shower trays

Article number	Description	61, 68, 69
9225 00 XX	Tempoplex Plus outlet Ø 90mm (required accessory) (please specify colour for the included outlet cover)	
9226 00 XX	Tempoplex Plus outlet Compact Ø 90mm (required accessory) (please specify colour for the included outlet cover)	
9226 02 XX	Spare outlet cover (on request)	
U9141 21 00	ViFrame installation frame, for smaller shower trays (up to 1000 x 1000 mm) made of ceramic or acrylic, incl. 2 central feet (on request)	
U9141 22 00	ViFrame installation frame, for larger shower trays (from 1000 x 1000 mm) made of ceramic or acrylic, incl. 4 central feet (on request)	

XX = Colour code to be indicated
 For further information on colours, please see the page at the beginning of this section.

SUBWAY INFINITY corner installation on the left or right against the wall (Square), Ceramic

€ excl. VAT

Technical information:

Ceramic available in White Alpin (01) with anti-slip class B (PN18), Taupe (TP), Ardoise (W9) and ViPrint décors with anti-slip class A (PN12).
These shower trays are cut on two sides (not glazed) and must be positioned on the left or right against the wall.
 Total price includes the surcharge for cutting!
 Please note: the outlet is positioned asymmetrically, not centrally!
 The installation height of the shower can be reduced by 30mm if outlet fitting 9226 00 XX is used.
 Please note: this outlet fitting does not conform to EN 274.
 *Shower trays marked with an asterisk can only be installed with ViFrame installation system or in a mortar bed.
 Shower tray, stepless access

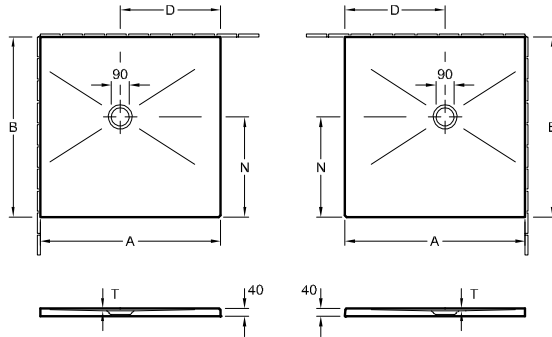
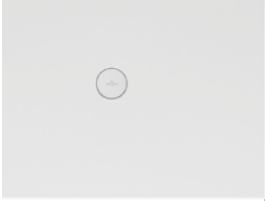

Article no.	A	B	D	N	T
6228 F4 XX	900	900	500	500	12

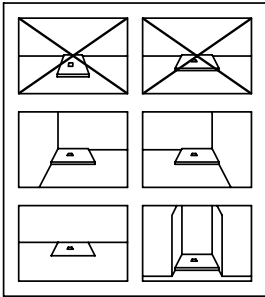

Article number	Size l x w x h	Weight (kg)	Waste ø	01	TP, W9	VPXX	pcs/pal.
6228 F4 XX	900 x 900 x 40 mm	34,02	90				10

Accessories for shower trays

Article number	Description	61, 68, 69
9225 00 XX	Tempoplex Plus outlet Ø 90mm (required accessory) (please specify colour for the included outlet cover)	
9226 00 XX	Tempoplex Plus outlet Compact Ø 90mm (required accessory) (please specify colour for the included outlet cover)	
9226 02 XX	Spare outlet cover (on request)	
U9141 21 00	ViFrame installation frame, for smaller shower trays (up to 1000 x 1000 mm) made of ceramic or acrylic, incl. 2 central feet (on request)	
U9141 22 00	ViFrame installation frame, for larger shower trays (from 1000 x 1000 mm) made of ceramic or acrylic, incl. 4 central feet (on request)	

XX = Colour code to be indicated
 For further information on colours, please see the page at the beginning of this section.

SHOWER TRAYS

SUBWAY INFINITY corner installation, right against the wall (Rectangle), Ceramic

€ excl. VAT

Technical information:

Ceramic available in White Alpin (01) with anti-slip class B (PN18), Taupe (TP), Ardoise (W9) and ViPrint décors with anti-slip class A (PN12).
These shower trays are cut along 2 sides (unglazed) and have to be installed on right against the wall
 Total price includes the surcharge for cutting!
 Please note: the outlet is positioned asymmetrically, not centrally!
 The installation height of the shower can be reduced by 30mm if outlet fitting 9226 00 XX is used.
 Please note: this outlet fitting does not conform to EN 274.
 *Shower trays marked with an asterisk can only be installed with ViFrame installation system or in a mortar bed.
 Shower tray, stepless access

SHOWER TRAYS

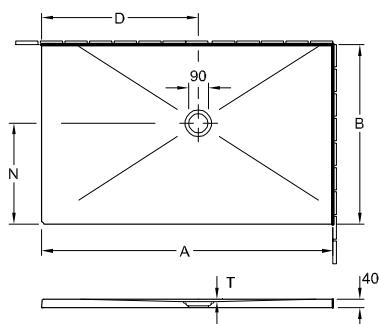
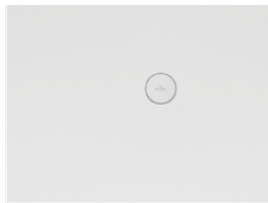

Article no.	A	B	D	N	T
6232 24 XX*	1500	900	800	500	12
6229 G2 XX	900	750	500	400	12
6229 G1 XX	900	700	500	400	12

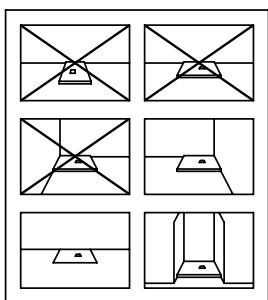

Article number	Size l x w x h	Weight (kg)	Waste ø	01	TP, W9	VPXX	pcs/pal.
6232 24 XX*	1500 x 900 x 40 mm	57,38	90				10
6229 G2 XX	900 x 750 x 40 mm	27,84					10
6229 G1 XX	900 x 700 x 40 mm	25,99					10

Accessories for shower trays

Article number	Description	61, 68, 69
9225 00 XX	Tempoplex Plus outlet Ø 90mm (required accessory) (please specify colour for the included outlet cover)	
9226 00 XX	Tempoplex Plus outlet Compact Ø 90mm (required accessory) (please specify colour for the included outlet cover)	
9226 02 XX	Spare outlet cover (on request)	
U9141 21 00	ViFrame installation frame, for smaller shower trays (up to 1000 x 1000 mm) made of ceramic or acrylic, incl. 2 central feet (on request)	
U9141 22 00	ViFrame installation frame, for larger shower trays (from 1000 x 1000 mm) made of ceramic or acrylic, incl. 4 central feet (on request)	

XX = Colour code to be indicated
 For further information on colours, please see the page at the beginning of this section.

SUBWAY INFINITY only flush-fit installation (Rectangle), Ceramic

€ excl. VAT

Technical information:

Ceramic available in White Alpin (01) with anti-slip class B (PN18), Taupe (TP), Ardoise (W9) and ViPrint décors with anti-slip class A (PN12).
These shower trays are cut along four sides (unglazed) and can be used for flush installation only.
 Total price includes the surcharge for cutting!
 Orders that we have confirmed for custom-made shower trays cannot be cancelled or altered.
 The installation height of the shower can be reduced by 30mm if outlet fitting 9226 00 XX is used.
 Please note: this outlet fitting does not conform to EN 274.
 *Shower trays marked with an asterisk can only be installed with ViFrame installation system or in a mortar bed.
 Shower tray, stepless access

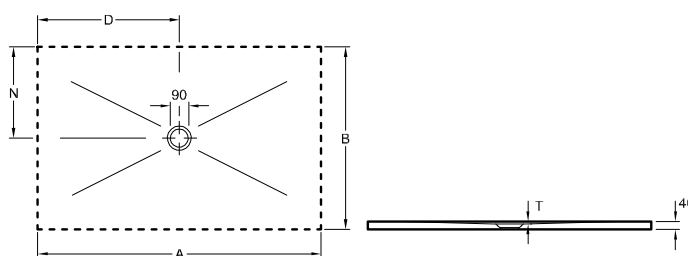
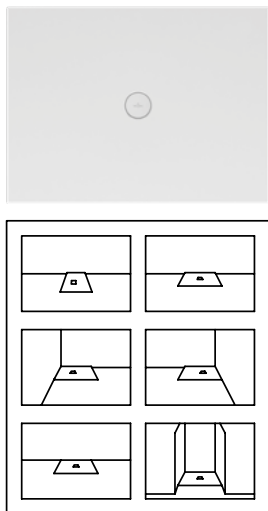

Article no.	A	B	D	N	T
6232 34 XX*	1500	900	750	450	12
6232 33 XX*	1500	800	750	400	12
6232 32 XX*	1500	750	750	375	12
6232 V4 XX*	1400	900	700	450	12
6232 V3 XX*	1400	800	700	400	12
6232 V2 XX*	1400	750	700	375	12
6232 N4 XX*	1200	900	600	450	12
6231 Q3 XX	1200	800	600	400	12
6231 Q2 XX	1200	750	600	375	12
6231 Q1 XX	1200	700	600	350	12
6230 L3 XX	1000	800	500	400	12
6230 L2 XX	1000	750	500	375	12
6230 L1 XX	1000	700	500	350	12
6229 H2 XX	900	750	450	375	12
6229 H1 XX	900	700	450	350	12
6229 C2 XX	800	750	400	375	12
6228 H3 XX	900	800	450	400	12
6228 H4 XX	900	900	450	450	12
6228 C3 XX	800	800	400	400	12

SHOWER TRAYS

Article number	Size l x w x h	Weight (kg)	Waste ø	01	TP, W9	VPXX	pcs/pal.
6232 34 XX*	1500 x 900 x 40 mm	57,38	90				10
6232 33 XX*	1500 x 800 x 40 mm	51					10
6232 32 XX*	1500 x 750 x 40 mm	47,81					10
6232 V4 XX*	1400 x 900 x 40 mm	53,55					10
6232 V3 XX*	1400 x 800 x 40 mm	47,6					10
6232 V2 XX*	1400 x 750 x 40 mm	44,63					10
6232 N4 XX*	1200 x 900 x 40 mm	68,5					10
6231 Q3 XX	1200 x 800 x 40 mm	40,38					10
6231 Q2 XX	1200 x 750 x 40 mm	37,86					10
6231 Q1 XX	1200 x 700 x 40 mm	35,33					10
6230 L3 XX	1000 x 800 x 40 mm	33,33					10
6230 L2 XX	1000 x 750 x 40 mm	31,25					10
6230 L1 XX	1000 x 700 x 40 mm	29,17					10
6229 H2 XX	900 x 750 x 40 mm	27,84					10
6229 H1 XX	900 x 700 x 40 mm	25,99					10
6229 C2 XX	800 x 750 x 40 mm	24,75					10
6228 H3 XX	900 x 800 x 40 mm	30,25				10	
6228 H4 XX	900 x 900 x 40 mm	34,02				10	
6228 C3 XX	800 x 800 x 40 mm	26,88				10	

Accessories for shower trays

Article number	Description	61, 68, 69
9225 00 XX	Tempoplex Plus outlet Ø 90mm (required accessory) (please specify colour for the included outlet cover)	
9226 00 XX	Tempoplex Plus outlet Compact Ø 90mm (required accessory) (please specify colour for the included outlet cover)	
9226 02 XX	Spare outlet cover (on request)	
U9141 21 00	ViFrame installation frame, for smaller shower trays (up to 1000 x 1000 mm) made of ceramic or acrylic, incl. 2 central feet (on request)	
U9141 22 00	ViFrame installation frame, for larger shower trays (from 1000 x 1000 mm) made of ceramic or acrylic, incl. 4 central feet (on request)	

XX = Colour code to be indicated
 For further information on colours, please see the page at the beginning of this section.

SUBWAY INFINITY

 (Customised dimensions and special form), Ceramic

€ excl. VAT

Technical information:

Ceramic available in White Alpin (01) with anti-slip class B (PN18), Taupe (TP), Ardoise (W9) and ViPrint décors with anti-slip class A (PN12).

For cut models, please state the exact dimension, see order form on page 411-412.

Total price includes the surcharge for cutting!

Orders that we have confirmed for custom-made shower trays cannot be cancelled or altered.

The installation height of the shower can be reduced by 30mm if outlet fitting 9226 00 XX is used.

Please note: this outlet fitting does not conform to EN 274.

*Shower trays marked with an asterisk can only be installed with ViFrame installation system or in a mortar bed.

Shower tray, stepless access

SHOWER TRAYS

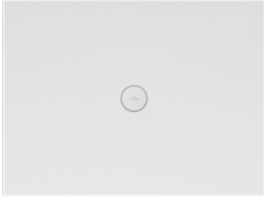

Article number	Size l x w x h	Weight (kg)	Waste ø	01	TP, W9	VPXX	pcs/ pal.
6232 SC XX*	1600 x 1000 x 40 mm	69,4	90				10
6231 SC XX	1400 x 900 x 40 mm	53					10
6230 SC XX	1200 x 900 x 40 mm	45					10
6229 SC XX	1000 x 800 x 40 mm	33					10
6228 SC XX	1000 x 1000 x 40 mm	42					10

Accessories for shower trays

Article number	Description	61, 68, 69
9225 00 XX	Tempoplex Plus outlet Ø 90mm (required accessory) (please specify colour for the included outlet cover)	
9226 00 XX	Tempoplex Plus outlet Compact Ø 90mm (required accessory) (please specify colour for the included outlet cover)	
9226 02 XX	Spare outlet cover (on request)	
U9141 21 00	ViFrame installation frame, for smaller shower trays (up to 1000 x 1000 mm) made of ceramic or acrylic, incl. 2 central feet (on request)	
U9141 22 00	ViFrame installation frame, for larger shower trays (from 1000 x 1000 mm) made of ceramic or acrylic, incl. 4 central feet (on request)	

XX = Colour code to be indicated

For further information on colours, please see the page at the beginning of this section.

SUBWAY INFINITY ORDER FORM

€ excl. VAT

Fax form for measuring and fitting

Wholesaler:	Fitter:	End customer:
Wholesaler order number:		
Name:	Name:	Name:
Contact person:	Contact person:	-
Address:	Address:	Address:
Postal code, town/city:	Postal code, town/city:	Postal code, town/city:
Tel. no.:	Tel. no.:	Tel. no.:
Fax:	Fax:	Fax:
E-Mail:	E-Mail:	E-Mail:
Contact details for person who took the measurements:		
Name:	Tel. no.:	
Address:	Fax:	
Postal code, town/city:	E-Mail:	

Please note:
 the length and width provided by you is the actual size of the shower tray requested. There must be at least a 5mm joint around the shower tray for silicon.
 For all Subway Infinity shower trays in sizes 1000x1000, 1000x800, 1200x900 and 1400x900mm, the area that can be cut to size is a minimum of 10mm and a maximum of 150mm per side. XXL shower trays (1600 x 1000 mm) are cut min. 10 mm / max. 150 mm on each long side and min. 10 mm / max. 200 mm on each short side.
Orders that we have confirmed for custom-made shower trays cannot be cancelled or altered.

Rectangular shower trays

Installation 1: installation with long side against the wall – long side of the shower tray is cut

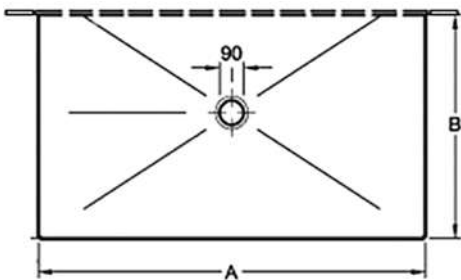

		A	B	
<input type="checkbox"/>	6232 SC	160		B: 850 - 990
<input type="checkbox"/>	6231 SC	140		B: 750 - 890
<input type="checkbox"/>	6230 SC	120		B: 750 - 890
<input type="checkbox"/>	6229 SC	100		B: 650 - 790
<input type="checkbox"/>	6228 SC	100		B: 850 - 990

Colour of the shower tray: 01 TP W9

VP ViPrint* Décor no.: _____ Décor name: _____

Installation 2: installation with short side against the wall – short side of the shower tray is cut

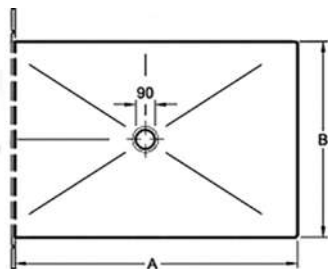

		A	B	
<input type="checkbox"/>	6232 SC		100	A: 1400 - 1590
<input type="checkbox"/>	6231 SC		90	A: 1250 - 1390
<input type="checkbox"/>	6230 SC		90	A: 1050 - 1190
<input type="checkbox"/>	6229 SC		80	A: 850 - 990
<input type="checkbox"/>	6228 SC		100	A: 850 - 990

Colour of the shower tray: 01 TP W9

VP ViPrint* Décor no.: _____ Décor name: _____

Installation 3: corner installation – 2 sides of the shower tray are cut – LEFT-HAND VERSION

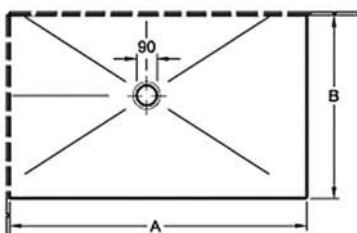

		A	B		
<input type="checkbox"/>	6232 SC			A: 1400 - 1590	B: 850 - 990
<input type="checkbox"/>	6231 SC			A: 1250 - 1390	B: 750 - 890
<input type="checkbox"/>	6230 SC			A: 1050 - 1190	B: 750 - 890
<input type="checkbox"/>	6229 SC			A: 850 - 990	B: 650 - 790
<input type="checkbox"/>	6228 SC			A: 850 - 990	B: 850 - 990

Colour of the shower tray: 01 TP W9

VP ViPrint* Décor no.: _____ Décor name: _____

SHOWER TRAYS

SUBWAY INFINITY ORDER FORM

€ excl. VAT

Fax form for measuring and fitting

Wholesaler:	Fitter:	End customer:
Wholesaler order number:		
Name:	Name:	Name:
Contact person:	Contact person:	-
Address:	Address:	Address:
Postal code, town/city:	Postal code, town/city:	Postal code, town/city:
Tel. no.:	Tel. no.:	Tel. no.:
Fax:	Fax:	Fax:
E-Mail:	E-Mail:	E-Mail:
Contact details for person who took the measurements:		
Name:	Tel. no.:	
Address:	Fax:	
Postal code, town/city:	E-Mail:	

Please note:

the length and width provided by you is the actual size of the shower tray requested. There must be at least a 5mm joint around the shower tray for silicon.
 For all Subway Infinity shower trays in sizes 1000x1000, 1000x800, 1200x900 and 1400x900mm, the area that can be cut to size is a minimum of 10mm and a maximum of 150mm per side. XXL shower trays (1600 x 1000 mm) are cut min. 10 mm / max. 150 mm on each long side and min. 10 mm / max. 200 mm on each short side.
Orders that we have confirmed for custom-made shower trays cannot be cancelled or altered.

Rectangular shower trays

Installation 4: corner installation – 2 sides of the shower tray are cut – RIGHT-HAND VERSION

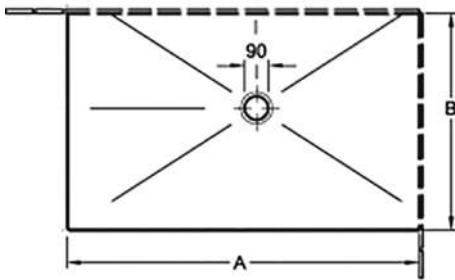

	A	B		
<input type="checkbox"/> 6232 SC			A: 1400 - 1590	B: 850 - 990
<input type="checkbox"/> 6231 SC			A: 1250 - 1390	B: 750 - 890
<input type="checkbox"/> 6230 SC			A: 1050 - 1190	B: 750 - 890
<input type="checkbox"/> 6229 SC			A: 850 - 990	B: 650 - 790
<input type="checkbox"/> 6228 SC			A: 850 - 990	B: 850 - 990

Colour of the shower tray: 01 TP W9

VP ViPrint* Décor no.: _____ Décor name: _____

Installation 5: flush installation – shower trays cut on all sides

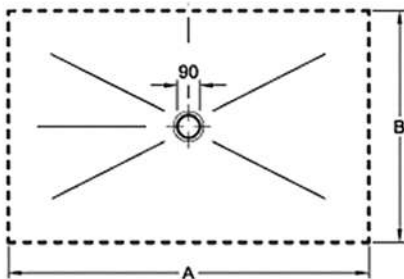

	A	B		
<input type="checkbox"/> 6232 SC			A: 1200 - 1580	B: 700 - 980
<input type="checkbox"/> 6231 SC			A: 1100 - 1380	B: 600 - 880
<input type="checkbox"/> 6230 SC			A: 900 - 1180	B: 600 - 880
<input type="checkbox"/> 6229 SC			A: 700 - 980	B: 500 - 780
<input type="checkbox"/> 6228 SC			A: 700 - 980	B: 700 - 980

Colour of the shower tray: 01 TP W9

VP ViPrint* Décor no.: _____ Décor name: _____

Installation 6: Special form, please enclose drawing. For all Subway Infinity shower trays in sizes 1000x1000, 1000x800, 1200x900 and 1400x900mm, the area that can be cut to size is a minimum of 10mm and a maximum of 150mm per side. XXL shower trays (1600 x 1000 mm) are cut min. 10 mm / max. 150 mm on each long side and min. 10 mm / max. 200 mm on each short side.

Example:

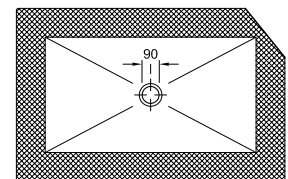
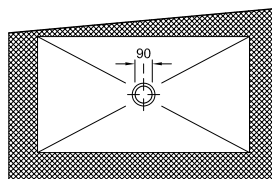
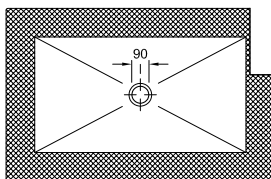

Colour of the shower tray: 01 TP W9

VP ViPrint* Décor no.: _____ Décor name: _____

*ViPrint décors and colour codes, see page 400-401

FUTURION FLAT (Square) Quarryl®

€ excl. VAT

Not included in scope of delivery:

All Futurion shower trays are supplied without support/base.

Technical information:

The installation height of the shower can be reduced to 105 mm if the Viega outlet fitting Art. no. 634 100 is used. Please note: This outlet fitting does not conform to EN 274.

Drainage Ø: 90 mm

Installation set U91411000 / U91411100:

Consisting of adjustable polystyrene support and sealing tape for installation flush with the floor. Including special adhesive.

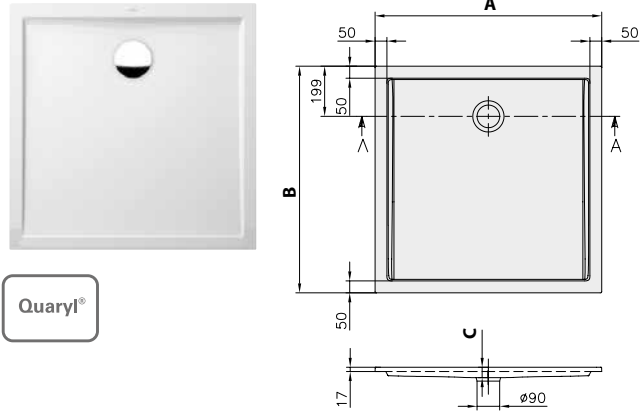

Quaryl®

Article number	Name and version	Size l (A) x w	Depth (C)	kg/pc.	01	pcs/pal.
UDQ 0900 FFL 1V-XX	Futurion Flat	900 x 900	25	20,6		10

Accessories for shower trays

Article number	Description	Price
U90880261	Tempoplex Plus outlet, plastic, ø 90 mm, Drainage capacity: 51 l/min, chrome	
U90880368	Tempoplex Plus outlet, plastic, ø 90 mm, Drainage capacity: 51 l/min, White	
U91411000	Installation set, for small sizes (900 x 800 - 1000 x 1000), incl. height-adjustable polystyrene rim support, incl. adhesive, incl. sealing tape, adjustable height 105 to 150 mm	
U91412300	ViFrame installation frame, for smaller shower trays made of Quarryl (up to 1000 x 1000 mm), without central foot	
U91412400	ViFrame installation frame, for larger shower trays made of Quarryl (from 1000 x 1000 mm), without central foot	

XX = Colour code to be indicated
For further information on colours, please see the page at the beginning of this section.

FUTURION FLAT (Rectangle) Quaryl®

€ excl. VAT

Not included in scope of delivery:

All Futurion shower trays are supplied without support/base.

Technical information:

The installation height of the shower can be reduced to 105 mm if the Viega outlet fitting Art. no. 634 100 is used. Please note: This outlet fitting does not conform to EN 274.

Drainage Ø: 90 mm

Installation set U91411000 / U91411100:

Consisting of adjustable polystyrene support and sealing tape for installation flush with the floor. Including special adhesive.

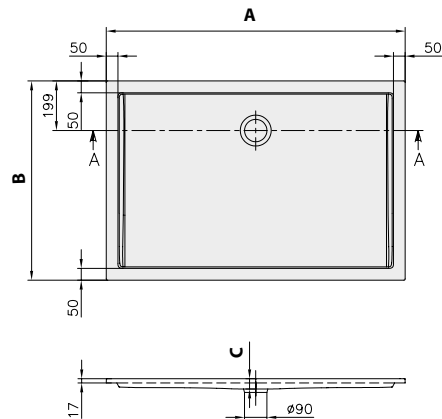

Article number	Name and version	Size l (A) x w	Depth (C)	kg/pc.	01	pcs/pal.
UDQ 1890 FFL 2V-XX	Futurion Flat	1800 x 900	25	41,3		10
UDQ 1690 FFL 2V-XX		1600 x 900		36,9		10
UDQ 1490 FFL 2V-XX		1400 x 900		32,4		10
UDQ 1290 FFL 2V-XX		1200 x 900		27,5		10
UDQ 1280 FFL 2V-XX		1200 x 800		24,5		10
UDQ 1800 FFL 2V-XX		1000 x 800		20,3		10

Accessories for shower trays

Article number	Description	Price
U90880261	Tempoplex Plus outlet, plastic, ø 90 mm, Drainage capacity: 51 l/min, chrome	
U90880368	Tempoplex Plus outlet, plastic, ø 90 mm, Drainage capacity: 51 l/min, White	
U91411000	Installation set, for small sizes (900 x 800 - 1000 x 1000), incl. height-adjustable polystyrene rim support, incl. adhesive, incl. sealing tape, adjustable height 105 to 150 mm	
U91411100	Installation set, for large sizes (1200 x 800 - 1800 x 1000), incl. height-adjustable polystyrene rim support, incl. adhesive, incl. sealing tape, adjustable height 105 to 150 mm, not suitable for the size 1200 x 1200 mm	
U91412300	ViFrame installation frame, for smaller shower trays made of Quaryl (up to 1000 x 1000 mm), without central foot	
U91412400	ViFrame installation frame, for larger shower trays made of Quaryl (from 1000 x 1000 mm), without central foot	

XX = Colour code to be indicated

For further information on colours, please see the page at the beginning of this section.

SQUARO Super Flat (Square) Quarryl®

€ excl. VAT

Included in scope of delivery:

Shower tray with integrated waste and waste cover.
 Supplied with the product are: flexible drain connection and polystyrene support set incl. sealant tape or completely integrated installation.
 Including special adhesive.
 Installation set with adjustable feet.

Drain already included in price! No need to order separately.

Technical information:

Drainage capacity: 36 l/min
 Installation height only 10 cm including siphon.



Quarryl®

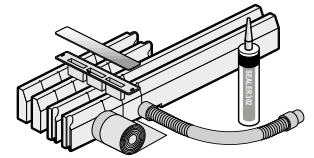
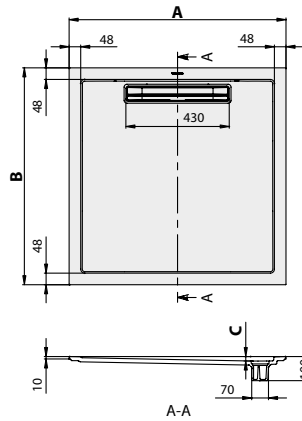

SHOWER TRAYS

Article number	Name and version	Size l (A) x w	Depth (C)	kg/pc.	01	1S, 2S, 3S, 4S, RW	pcs/pal.
UDQ 1010 SQR 1V-XX	Squaro, Super Flat	1000 x 1000	18	27,6			10
UDQ 0910 SQR 1V-XX		900 x 900		23			10

SQUARO Super Flat (Rectangle) Quarryl®

Included in scope of delivery:

Shower tray with integrated waste and waste cover.
 Supplied with the product are: flexible drain connection and polystyrene support set incl. sealant tape or completely integrated installation.
 Including special adhesive.
 Installation set with adjustable feet.

Drain already included in price! No need to order separately.

Technical information:

Drainage capacity: 50 l/min
 Installation height only 10 cm including siphon.



Quarryl®

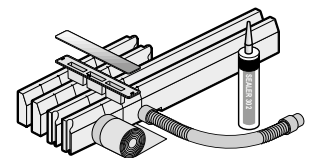
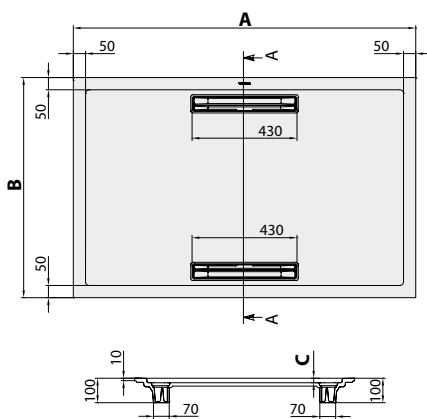

Article number	Name and version	Size l (A) x w	Depth (C)	kg/pc.	01	1S, 2S, 3S, 4S, RW	pcs/pal.
UDQ 1890 SQR 2V-XX	Squaro, Super Flat	1800 x 900	18	49,2			10
UDQ 1780 SQR 2V-XX		1700 x 800		40,1			10
UDQ 1690 SQR 2V-XX		1600 x 900		43,5			10
UDQ 1490 SQR 2V-XX		1400 x 900		38,4			10

XX = Colour code to be indicated
 For further information on colours, please see the page at the beginning of this section.

SQUARO Super Flat (Rectangle) Quarryl®

€ excl. VAT

Included in scope of delivery:

Shower tray with integrated waste and waste cover.
 Supplied with the product are: flexible drain connection and polystyrene support set incl. sealant tape or completely integrated installation.
 Including special adhesive.
 Installation set with adjustable feet.

Drain already included in price! No need to order separately.

Technical information:

Drainage capacity: 36 l/min
 Installation height only 10 cm including siphon.

SHOWER TRAYS

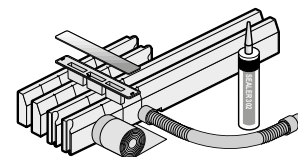
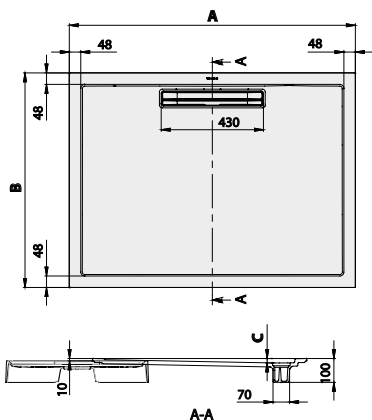

Article number	Name and version	Size l (A) x w	Depth (C)	kg/pc.	01	1S, 2S, 3S, 4S, RW	pcs/pal.
UDQ 1290 SQR 2V-XX	Squaro, Super Flat	1200 x 900	18	29,4			10

XX = Colour code to be indicated
 For further information on colours, please see the page at the beginning of this section.

SQUARO INFINITY SHOWER TRAYS



€ excl. VAT

With Squaro Infinity, Villeroy & Boch is presenting innovative Quarry® shower trays that can be cut to size. With the Infinity concept, Villeroy & Boch offers all shower lovers a wealth of possibilities thanks to shower trays that can be cut to size to fit the respective room.

Variety down to the last millimetre, maximum adaptability

- 49 models ranging from 1800 x 1000 to 800 x 700 mm
- Further dimensions can be cut to size down to the last millimetre
- In the case of complex shapes, such as corners, pedestals and projections, special shapes are possible
- Ribbed technology for greater stability when cutting

Minimalist design

- Ultra-flat, rimless look
- Floor-flush integrated designer outlet: colour-coded to match the shower tray and finished with chrome-plated strip, particularly easy to clean, removable, therefore extremely functional
- Drainage rate of 48 l / min well above standard

Colour selection with maximum safety

- For a consistent look: 5 colours to match the Villeroy & Boch floor tiles - Anthracite, Crème, Grey, Brown, Stone White
- Maximum anti-slip class C

Easy and safe installation

- 3 installation variants for maximum flexibility: floor-flush installation, installation on tiles, installation on skirting
- Simple standard assembly similar to Squaro Superflat shower trays

4 convincing benefits of Quarry®

- Unique & precise
- Solid & robust
- Clean & safe
- Warm & feels soft to the touch

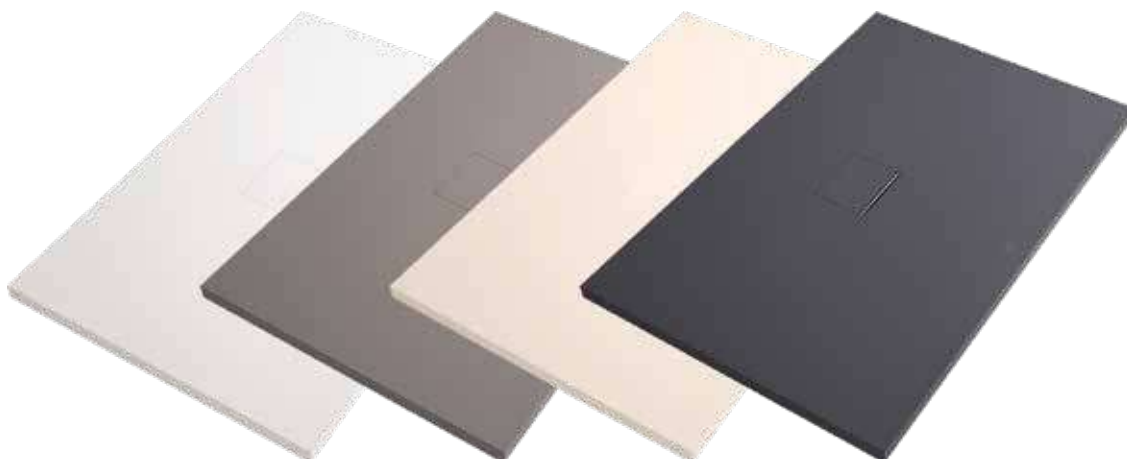

Shower trays Squaro Infinity

Matt colours (Colorline)



1S Anthracite



2S Crème



3S Grey



4S Brown



RW Stone White

Not available in glossy colours!

Depending on the material and light incidence, slight colour deviations may occur between the outlet cover and the shower tray.

For information on Squaro Infinity visit our website
PRO.VILLEROY-BOCH.COM/SQUAROINFINITY

SQUARO INFINITY

€ excl. VAT

How do I order?

SHOWER TRAYS

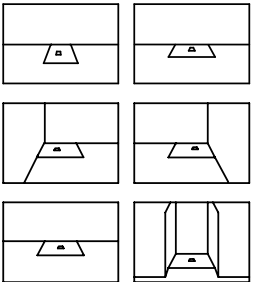
Length	Width	Flush-fitting installation	Resting installation					
		Page 419, 420, 421, 422, 423	Page 419	Page 419, 422	Page 419, 420, 422	Page 419, 421, 422	Page 419, 420, 421, 422	
								
800	700	<input type="radio"/>	-	-	<input type="radio"/>	<input type="radio"/>	<input type="radio"/>	
	750	<input type="radio"/>	-	-	<input type="radio"/>	<input type="radio"/>	<input type="radio"/>	
	800	<input type="radio"/>	-	-	<input type="radio"/>	<input type="radio"/>	<input type="radio"/>	
900	700	<input type="radio"/>	-	<input type="radio"/>	<input type="radio"/>	<input type="radio"/>	<input type="radio"/>	
	750	<input type="radio"/>	-	<input type="radio"/>	<input type="radio"/>	<input type="radio"/>	<input type="radio"/>	
	800	<input type="radio"/>	<input type="radio"/>	<input type="radio"/>	<input type="radio"/>	<input type="radio"/>	<input type="radio"/>	
	900	<input type="radio"/>	<input type="radio"/>	<input type="radio"/>	<input type="radio"/>	<input type="radio"/>	<input type="radio"/>	
1000	700	<input type="radio"/>	-	-	<input type="radio"/>	<input type="radio"/>	<input type="radio"/>	
	750	<input type="radio"/>	-	-	<input type="radio"/>	<input type="radio"/>	<input type="radio"/>	
	800	<input type="radio"/>	-	-	<input type="radio"/>	<input type="radio"/>	<input type="radio"/>	
	900	<input type="radio"/>	<input type="radio"/>	<input type="radio"/>	<input type="radio"/>	<input type="radio"/>	<input type="radio"/>	
	1000	<input type="radio"/>	<input type="radio"/>	<input type="radio"/>	<input type="radio"/>	<input type="radio"/>	<input type="radio"/>	
1100	700	<input type="radio"/>	-	-	<input type="radio"/>	<input type="radio"/>	<input type="radio"/>	
	750	<input type="radio"/>	-	-	<input type="radio"/>	<input type="radio"/>	<input type="radio"/>	
	800	<input type="radio"/>	-	-	<input type="radio"/>	<input type="radio"/>	<input type="radio"/>	
	900	<input type="radio"/>	-	-	<input type="radio"/>	<input type="radio"/>	<input type="radio"/>	
1200	700	<input type="radio"/>	-	<input type="radio"/>	<input type="radio"/>	<input type="radio"/>	<input type="radio"/>	
	750	<input type="radio"/>	-	<input type="radio"/>	<input type="radio"/>	<input type="radio"/>	<input type="radio"/>	
	800	<input type="radio"/>	<input type="radio"/>	<input type="radio"/>	<input type="radio"/>	<input type="radio"/>	<input type="radio"/>	
	900	<input type="radio"/>	<input type="radio"/>	<input type="radio"/>	<input type="radio"/>	<input type="radio"/>	<input type="radio"/>	
1300	700	<input type="radio"/>	-	-	<input type="radio"/>	<input type="radio"/>	<input type="radio"/>	
	750	<input type="radio"/>	-	-	<input type="radio"/>	<input type="radio"/>	<input type="radio"/>	
	800	<input type="radio"/>	-	-	<input type="radio"/>	<input type="radio"/>	<input type="radio"/>	
	900	<input type="radio"/>	-	-	<input type="radio"/>	<input type="radio"/>	<input type="radio"/>	
1400	700	<input type="radio"/>	-	<input type="radio"/>	<input type="radio"/>	<input type="radio"/>	<input type="radio"/>	
	750	<input type="radio"/>	-	<input type="radio"/>	<input type="radio"/>	<input type="radio"/>	<input type="radio"/>	
	800	<input type="radio"/>	<input type="radio"/>	<input type="radio"/>	<input type="radio"/>	<input type="radio"/>	<input type="radio"/>	
	900	<input type="radio"/>	<input type="radio"/>	<input type="radio"/>	<input type="radio"/>	<input type="radio"/>	<input type="radio"/>	
	1000	<input type="radio"/>	-	-	-	-	-	
1500	700	<input type="radio"/>	-	-	<input type="radio"/>	<input type="radio"/>	<input type="radio"/>	
	750	<input type="radio"/>	-	-	<input type="radio"/>	<input type="radio"/>	<input type="radio"/>	
	800	<input type="radio"/>	-	-	<input type="radio"/>	<input type="radio"/>	<input type="radio"/>	
	900	<input type="radio"/>	-	-	<input type="radio"/>	<input type="radio"/>	<input type="radio"/>	
	1000	<input type="radio"/>	-	-	-	-	-	
1600	700	<input type="radio"/>	-	<input type="radio"/>	<input type="radio"/>	<input type="radio"/>	<input type="radio"/>	
	750	<input type="radio"/>	-	<input type="radio"/>	<input type="radio"/>	<input type="radio"/>	<input type="radio"/>	
	800	<input type="radio"/>	<input type="radio"/>	<input type="radio"/>	<input type="radio"/>	<input type="radio"/>	<input type="radio"/>	
	900	<input type="radio"/>	<input type="radio"/>	<input type="radio"/>	<input type="radio"/>	<input type="radio"/>	<input type="radio"/>	
	1000	<input type="radio"/>	-	-	<input type="radio"/>	<input type="radio"/>	<input type="radio"/>	
1700	700	<input type="radio"/>	-	-	<input type="radio"/>	<input type="radio"/>	<input type="radio"/>	
	750	<input type="radio"/>	-	-	<input type="radio"/>	<input type="radio"/>	<input type="radio"/>	
	800	<input type="radio"/>	-	-	<input type="radio"/>	<input type="radio"/>	<input type="radio"/>	
	900	<input type="radio"/>	-	-	<input type="radio"/>	<input type="radio"/>	<input type="radio"/>	
	1000	<input type="radio"/>	-	-	<input type="radio"/>	<input type="radio"/>	<input type="radio"/>	
1800	700	<input type="radio"/>	-	<input type="radio"/>	<input type="radio"/>	<input type="radio"/>	<input type="radio"/>	
	750	<input type="radio"/>	-	<input type="radio"/>	<input type="radio"/>	<input type="radio"/>	<input type="radio"/>	
	800	<input type="radio"/>	<input type="radio"/>	<input type="radio"/>	<input type="radio"/>	<input type="radio"/>	<input type="radio"/>	
	900	<input type="radio"/>	-	<input type="radio"/>	<input type="radio"/>	<input type="radio"/>	<input type="radio"/>	
	1000	<input type="radio"/>	<input type="radio"/>	<input type="radio"/>	<input type="radio"/>	<input type="radio"/>	<input type="radio"/>	

For other dimensions see page 424.

Special shapes see order form or page 424.

The symbol "o" means: this size is possible.

SQUARO INFINITY standard models for all installation types Quarryl®

€ excl. VAT

Included in scope of delivery:
Not included in scope of delivery:
Technical information:

Outlet cover in matching matt colour with chrome-plated strip.
 All shower trays are supplied without support/base.
 Drainage capacity: 48 l/min
 The installation height of the shower tray can be reduced by 30 mm if the Viega outlet fitting art. no. 634 100 is used. Please note: this outlet fitting does not conform to EN 274.
 All shower trays are classified as anti-slip class C (in accordance with DIN51097)
These shower trays are not cut and can be used for all types of installation (recessed in the floor, on the floor, on a base).
Quarryl shower trays can be cut to size on site according to the installation instructions; detailed video at pro.villeroy-boch.com/squaroinfinity or QR code on this page.
 Shower tray, stepless access

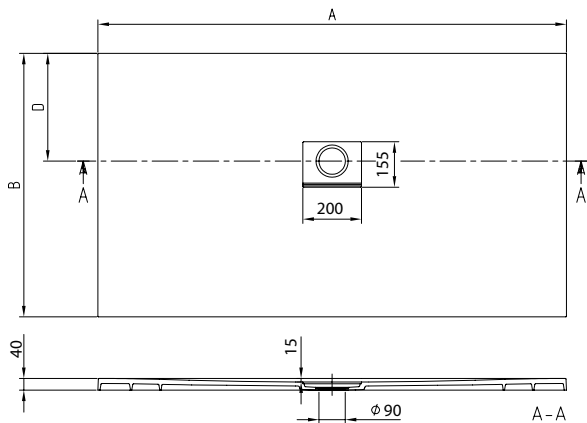
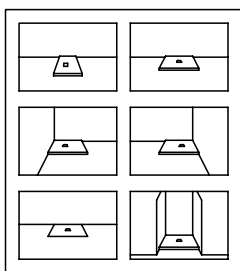

SHOWER TRAYS

Quarryl®

Article number	Name and version	Size l (A) x w	Waste size D	Depth (C)	kg/pc.	1S, 2S, 3S, 4S, RW	pcs/pal.
UDQ 1810 SQI 2V-XX	Squaro Infinity, standard models for all installation types	1800 x 1000	418	15	48,9		10
UDQ 1880 SQI 2V-XX		1800 x 800	318		37,8		10
UDQ 1690 SQI 2V-XX		1600 x 900	368		38,4		10
UDQ 1680 SQI 2V-XX		1600 x 800	318		34,3		10
UDQ 1490 SQI 2V-XX		1400 x 900	368		33,9		10
UDQ 1480 SQI 2V-XX		1400 x 800	318		30,1		10
UDQ 1290 SQI 2V-XX		1200 x 900	368		29,4		10
UDQ 1280 SQI 2V-XX		1200 x 800	318				10
UDQ 1010 SQI 1V-XX		1000 x 1000	418		26,4		10
UDQ 1090 SQI 2V-XX		1000 x 900	368		23,9		10
UDQ 9090 SQI 1V-XX		900 x 900	318		21,6		10
UDQ 9080 SQI 2V-XX		900 x 800	318		19,2		10

Accessories for shower trays

Article number	Description	Price
U90881299	Tempoplex Plus outlet, plastic, ϕ 90 mm, without cover	
U91411000	Installation set, for small sizes (900 x 800 - 1000 x 1000), incl. height-adjustable polystyrene rim support, incl. adhesive, incl. sealing tape, adjustable height 105 to 150 mm	
U91411100	Installation set, for large sizes (1200 x 800 - 1800 x 1000), incl. height-adjustable polystyrene rim support, incl. adhesive, incl. sealing tape, adjustable height 105 to 150 mm, not suitable for the size 1200 x 1200 mm	
U91412300	ViFrame installation frame, for smaller shower trays made of Quarryl (up to 1000 x 1000 mm), without central foot	
U91412400	ViFrame installation frame, for larger shower trays made of Quarryl (from 1000 x 1000 mm), without central foot	

XX = Colour code to be indicated
 For further information on colours, please see the page at the beginning of this section.

SQUARO INFINITY corner installation, left against the wall Quarryl®

€ excl. VAT

Included in scope of delivery:

Outlet cover in matching matt colour with chrome-plated strip.

The extra charge for cutting already in the total price!

Not included in scope of delivery:

All shower trays are supplied without support/base.

With cut shower trays, we recommend the use of a composite seal in accordance with ETAG 022 on the floor structure below the shower tray in order to prevent any moisture from penetrating the floor structure.

Technical information:

Cut shower tray (side unprocessed).

Drainage capacity: 48 l/min

The installation height of the shower tray can be reduced by 30 mm if the Viega outlet fitting art. no. 634 100 is used. Please note: this outlet fitting does not conform to EN 274.

All shower trays are classified as anti-slip class C (in accordance with DIN51097)

Surface-mounted models can be fitted in corners on the left against the wall, in a niche or flush-fit with the floor.

Quarryl shower trays can be cut to size on site according to the installation instructions; detailed video at pro.villeroy-boch.com/squaroinfinity or QR code on this page.

Shower tray, stepless access

These shower trays are cut on two sides, some sizes only on the short side (see sizes marked with *).

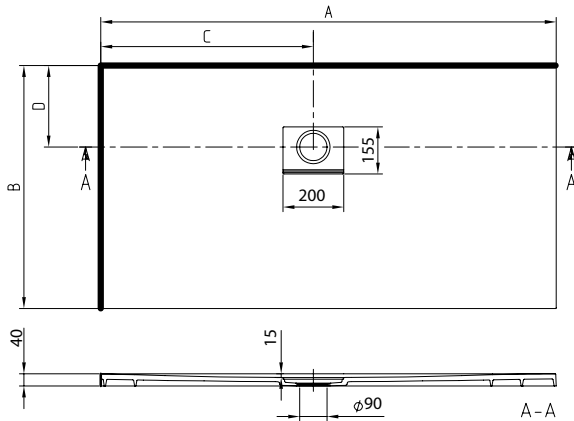
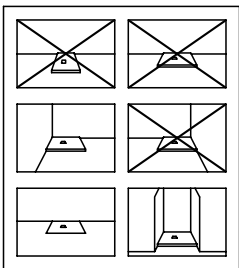
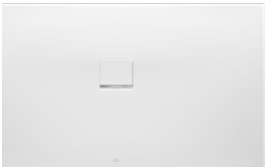

Article number	Name and version	Size l (A) x w	Waste size C	Waste size D	Depth (C)	kg/pc.	1S, 2S, 3S, 4S, RW	pcs/pal.
UDQ 1710 SQI 2LV-XX	Squaro Infinity, corner installation, left against the wall	1700 x 1000*	800	418	15	48,4		1
UDQ 1790 SQI 2LV-XX		1700 x 900		318		43,4		1
UDQ 1780 SQI 2LV-XX		1700 x 800*		268		36,4		1
UDQ 1775 SQI 2LV-XX		1700 x 750		218		34,6		1
UDQ 1770 SQI 2LV-XX		1700 x 700	160	33,6		1		
UDQ 1610 SQI 2LV-XX		1600 x 1000*	700	418		45,4		1
UDQ 1590 SQI 2LV-XX		1500 x 900*		368		37,4		1
UDQ 1580 SQI 2LV-XX		1500 x 800*		318		33,6		1
UDQ 1575 SQI 2LV-XX		1500 x 750		268		32,6		1
UDQ 1570 SQI 2LV-XX		1500 x 700	218	31,6		1		
UDQ 1390 SQI 2LV-XX		1300 x 900*	600	368		30,6		1
UDQ 1380 SQI 2LV-XX		1300 x 800*		318		28,6		1
UDQ 1375 SQI 2LV-XX		1300 x 750		268		27,6		1
UDQ 1370 SQI 2LV-XX		1300 x 700	218	26,6		1		
UDQ 1190 SQI 2LV-XX		1100 x 900*	500	368		28,6		1
UDQ 1180 SQI 2LV-XX		1100 x 800*		318		25,6		1
UDQ 1175 SQI 2LV-XX		1100 x 750		268		23,6		1
UDQ 1170 SQI 2LV-XX		1100 x 700		218		22,6		1
UDQ 1075 SQI 2LV-XX		1000 x 750		268		21,6		1
UDQ 1070 SQI 2LV-XX		1000 x 700		218		20,6		1
UDQ 8080 SQI 1LV-XX		800 x 800*	350	318		18,6		1
UDQ 8075 SQI 2LV-XX		800 x 750		268				1
UDQ 8070 SQI 2LV-XX		800 x 700		218				1

Accessories for shower trays

Article number	Description	Price
U90881299	Tempoplex Plus outlet, plastic, ø 90 mm, without cover	
U91411000	Installation set, for small sizes (900 x 800 - 1000 x 1000), incl. height-adjustable polystyrene rim support, incl. adhesive, incl. sealing tape, adjustable height 105 to 150 mm	
U91411100	Installation set, for large sizes (1200 x 800 - 1800 x 1000), incl. height-adjustable polystyrene rim support, incl. adhesive, incl. sealing tape, adjustable height 105 to 150 mm, not suitable for the size 1200 x 1200 mm	
U91412300	ViFrame installation frame, for smaller shower trays made of Quarryl (up to 1000 x 1000 mm), without central foot	
U91412400	ViFrame installation frame, for larger shower trays made of Quarryl (from 1000 x 1000 mm), without central foot	

XX = Colour code to be indicated
For further information on colours, please see the page at the beginning of this section.

SQUARO INFINITY corner installation, right against the wall Quarryl®

€ excl. VAT

Included in scope of delivery:

Outlet cover in matching matt colour with chrome-plated strip.
The extra charge for cutting already in the total price!

Not included in scope of delivery:

All shower trays are supplied without support/base.
 With cut shower trays, we recommend the use of a composite seal in accordance with ETAG 022 on the floor structure below the shower tray in order to prevent any moisture from penetrating the floor structure.

Technical information:

Cut shower tray (side unprocessed).
 Drainage capacity: 48 l/min
 The installation height of the shower tray can be reduced by 30 mm if the Viega outlet fitting art. no. 634 100 is used. Please note: this outlet fitting does not conform to EN 274.
 All shower trays are classified as anti-slip class C (in accordance with DIN51097)
Surface-mounted models can be fitted in corners on the right against the wall, in a niche or flush-fit with the floor.
Quarryl shower trays can be cut to size on site according to the installation instructions; detailed video at pro.villeroy-boch.com/squaroinfinity or QR code on this page.
 Shower tray, stepless access
These shower trays are cut on two sides, some sizes only on the short side (see sizes marked with *).

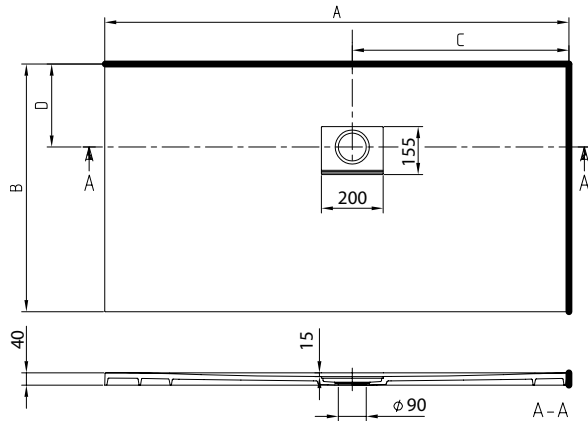
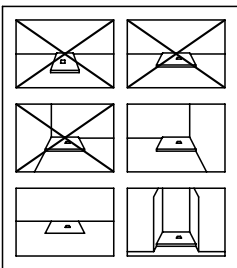
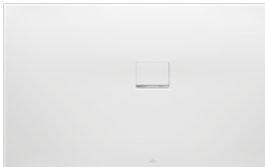

Article number	Name and version	Size l (A) x w	Waste size C	Waste size D	Depth (C)	kg/pc.	1S, 2S, 3S, 4S, RW	pcs/pal.
UDQ 1710 SQI 2RV-XX	Squaro Infinity, corner installation, right against the wall	1700 x 1000*	800	418	15	48,4		1
UDQ 1790 SQI 2RV-XX		1700 x 900		318		43,4		1
UDQ 1780 SQI 2RV-XX		1700 x 800*		268		36,4		1
UDQ 1775 SQI 2RV-XX		1700 x 750		218		34,6		1
UDQ 1770 SQI 2RV-XX		1700 x 700		168		33,6		1
UDQ 1610 SQI 2RV-XX		1600 x 1000*	700	418		45,4		1
UDQ 1590 SQI 2RV-XX		1500 x 900*		368		37,4		1
UDQ 1580 SQI 2RV-XX		1500 x 800*		318		33,6		1
UDQ 1575 SQI 2RV-XX		1500 x 750		268		32,6		1
UDQ 1570 SQI 2RV-XX		1500 x 700		218		31,6		1
UDQ 1390 SQI 2RV-XX		1300 x 900*	600	368		30,6		1
UDQ 1380 SQI 2RV-XX		1300 x 800*		318		28,6		1
UDQ 1375 SQI 2RV-XX		1300 x 750		268		27,6		1
UDQ 1370 SQI 2RV-XX		1300 x 700		218		26,6		1
UDQ 1190 SQI 2RV-XX		1100 x 900*	500	368		28,6		1
UDQ 1180 SQI 2RV-XX		1100 x 800*		318		25,6		1
UDQ 1175 SQI 2RV-XX		1100 x 750		268		23,6		1
UDQ 1170 SQI 2RV-XX		1100 x 700		218		22,6		1
UDQ 1075 SQI 2RV-XX		1000 x 750		268		21,6		1
UDQ 1070 SQI 2RV-XX		1000 x 700		218		20,6		1
UDQ 8080 SQI 1RV-XX		800 x 800*	350	318		18,6		1
UDQ 8075 SQI 2RV-XX		800 x 750		268		18,6		1
UDQ 8070 SQI 2RV-XX		800 x 700		218		18,6		1

Accessories for shower trays

Article number	Description	Price
U90881299	Tempoplex Plus outlet, plastic, ø 90 mm, without cover	
U91411000	Installation set, for small sizes (900 x 800 - 1000 x 1000), incl. height-adjustable polystyrene rim support, incl. adhesive, incl. sealing tape, adjustable height 105 to 150 mm	
U91411100	Installation set, for large sizes (1200 x 800 - 1800 x 1000), incl. height-adjustable polystyrene rim support, incl. adhesive, incl. sealing tape, adjustable height 105 to 150 mm, not suitable for the size 1200 x 1200 mm	
U91412300	ViFrame installation frame, for smaller shower trays made of Quarryl (up to 1000 x 1000 mm), without central foot	
U91412400	ViFrame installation frame, for larger shower trays made of Quarryl (from 1000 x 1000 mm), without central foot	

XX = Colour code to be indicated
 For further information on colours, please see the page at the beginning of this section.

SHOWER TRAYS

SQUARO INFINITY long side cut against wall, for all installation types Quarryl®

€ excl. VAT

Included in scope of delivery: Outlet cover in matching matt colour with chrome-plated strip.

The extra charge for cutting already in the total price!

Not included in scope of delivery: All shower trays are supplied without support/base.

With cut shower trays, we recommend the use of a composite seal in accordance with ETAG 022 on the floor structure below the shower tray in order to prevent any moisture from penetrating the floor structure.

Technical information: Cut shower tray (side unprocessed).

Drainage capacity: 48 l/min

The installation height of the shower tray can be reduced by 30 mm if the Viega outlet fitting art. no. 634 100 is used. Please note: this outlet fitting does not conform to EN 274.

All shower trays are classified as anti-slip class C (in accordance with DIN51097)

Quaryl shower trays can be cut to size on site according to the installation instructions; detailed video at pro.villeroy-boch.com/squaroinfinity or QR code on this page.

Surface-mounted models can be fitted centred, in corners on the left or right against the wall, in a niche or flush-fit with the floor.

Shower tray, stepless access

SHOWER TRAYS

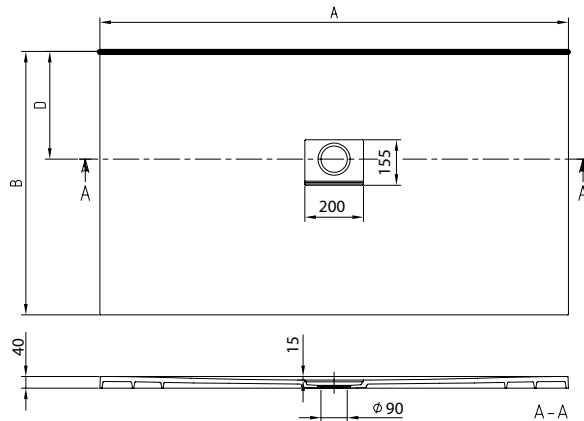
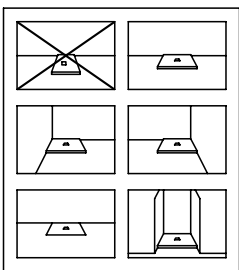

Quaryl®

Article number	Name and version	Size l (A) x w	Waste size D	Depth (C)	kg/pc.	1S, 2S, 3S, 4S, RW	pcs/pal.
UDQ 1890 SQI 2BV-XX	Squaro Infinity, long side cut against wall, for all installation types	1800 x 900	318	15	46,4		1
UDQ 1875 SQI 2BV-XX		1800 x 750	268		36,4		1
UDQ 1870 SQI 2BV-XX		1800 x 700	218		35,4		1
UDQ 1675 SQI 2BV-XX		1600 x 750	268		33,6		1
UDQ 1670 SQI 2BV-XX		1600 x 700	218		32,6		1
UDQ 1475 SQI 2BV-XX		1400 x 750	268		31,6		1
UDQ 1470 SQI 2BV-XX		1400 x 700	218		30,6		1
UDQ 1275 SQI 2BV-XX		1200 x 750	268		26,6		1
UDQ 1270 SQI 2BV-XX		1200 x 700	218		25,6		1
UDQ 1080 SQI 2BV-XX		1000 x 800	268		22,6		1
UDQ 9075 SQI 2BV-XX		900 x 750	268		19,6		1
UDQ 9070 SQI 2BV-XX		900 x 700	218		18,6		1

Accessories for shower trays

Article number	Description	Price
U90881299	Tempoplex Plus outlet, plastic, ø 90 mm, without cover	
U91411000	Installation set, for small sizes (900 x 800 - 1000 x 1000), incl. height-adjustable polystyrene rim support, incl. adhesive, incl. sealing tape, adjustable height 105 to 150 mm	
U91411100	Installation set, for large sizes (1200 x 800 - 1800 x 1000), incl. height-adjustable polystyrene rim support, incl. adhesive, incl. sealing tape, adjustable height 105 to 150 mm, not suitable for the size 1200 x 1200 mm	
U91412300	ViFrame installation frame, for smaller shower trays made of Quaryl (up to 1000 x 1000 mm), without central foot	
U91412400	ViFrame installation frame, for larger shower trays made of Quaryl (from 1000 x 1000 mm), without central foot	

XX = Colour code to be indicated
For further information on colours, please see the page at the beginning of this section.

SQUARO INFINITY Installation: flush-fitting / in a niche Quarryl®

€ excl. VAT

Included in scope of delivery: Outlet cover in matching matt colour with chrome-plated strip.
The extra charge for cutting already in the total price!

Not included in scope of delivery: All shower trays are supplied without support/base. With cut shower trays, we recommend the use of a composite seal in accordance with ETAG 022 on the floor structure below the shower tray in order to prevent any moisture from penetrating the floor structure.

Technical information: Cut shower tray (side unprocessed).
Drainage capacity: 48 l/min
The installation height of the shower tray can be reduced by 30 mm if the Viega outlet fitting art. no. 634 100 is used. Please note: this outlet fitting does not conform to EN 274.

All shower trays are classified as anti-slip class C (in accordance with DIN51097)

Surface-mounted models can be fitted in a niche or flush-fit with the floor.

Quaryl shower trays can be cut to size on site according to the installation instructions; detailed video at pro.villeroy-boch.com/squaroinfinity or QR code on this page.

Shower tray, stepless access

These shower trays are cut on three sides, some sizes only on the short side (see sizes marked with *).

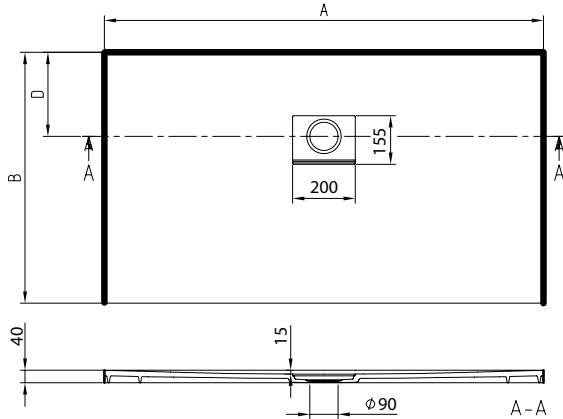
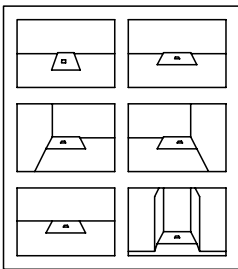

Article number	Name and version	Size l (A) x w	Waste size D	Depth (C)	kg/pc.	1S, 2S, 3S, 4S, RW	pcs/pal.
UDQ 1710 SQI 2IV-XX	Squaro Infinity, Installation: flush-fitting / in a niche	1700 x 1000*	418	15	48,4		1
UDQ 1790 SQI 2IV-XX		1700 x 900	318		43,4		1
UDQ 1780 SQI 2IV-XX		1700 x 800*			36,4		1
UDQ 1775 SQI 2IV-XX		1700 x 750	268		34,6		1
UDQ 1770 SQI 2IV-XX		1700 x 700	218		33,6		1
UDQ 1610 SQI 2IV-XX		1600 x 1000*			45,4		1
UDQ 1510 SQI 2IV-XX		1500 x 1000*	418		42,4		1
UDQ 1590 SQI 2IV-XX		1500 x 900*	368		37,4		1
UDQ 1580 SQI 2IV-XX		1500 x 800*	318		33,6		1
UDQ 1575 SQI 2IV-XX		1500 x 750	268		32,6		1
UDQ 1570 SQI 2IV-XX		1500 x 700	218		31,6		1
UDQ 1410 SQI 2IV-XX		1400 x 1000*	418		39,4		1
UDQ 1390 SQI 2IV-XX		1300 x 900*	368		30,6		1
UDQ 1380 SQI 2IV-XX		1300 x 800*	318		28,6		1
UDQ 1375 SQI 2IV-XX		1300 x 750	268		27,6		1
UDQ 1370 SQI 2IV-XX		1300 x 700	218		26,6		1
UDQ 1190 SQI 2IV-XX		1100 x 900*	368		28,6		1
UDQ 1180 SQI 2IV-XX		1100 x 800	318		25,6		1
UDQ 1175 SQI 2IV-XX		1100 x 750	268		23,6		1
UDQ 1170 SQI 2IV-XX		1100 x 700	218		22,6		1
UDQ 1075 SQI 2IV-XX		1000 x 750	268		21,6		1
UDQ 1070 SQI 2IV-XX		1000 x 700	218		20,6		1
UDQ 8080 SQI 1IV-XX		800 x 800*	318				1
UDQ 8075 SQI 2IV-XX		800 x 750	268		18,6		1
UDQ 8070 SQI 2IV-XX		800 x 700	218				1

Accessories for shower trays

Article number	Description	Price
U90881299	Tempoplex Plus outlet, plastic, ø 90 mm, without cover	
U91411000	Installation set, for small sizes (900 x 800 - 1000 x 1000), incl. height-adjustable polystyrene rim support, incl. adhesive, incl. sealing tape, adjustable height 105 to 150 mm	
U91411100	Installation set, for large sizes (1200 x 800 - 1800 x 1000), incl. height-adjustable polystyrene rim support, incl. adhesive, incl. sealing tape, adjustable height 105 to 150 mm, not suitable for the size 1200 x 1200 mm	
U91412300	ViFrame installation frame, for smaller shower trays made of Quaryl (up to 1000 x 1000 mm), without central foot	
U91412400	ViFrame installation frame, for larger shower trays made of Quaryl (from 1000 x 1000 mm), without central foot	

XX = Colour code to be indicated

For further information on colours, please see the page at the beginning of this section.

SHOWER TRAYS

ORDER FORM SQUARO INFINITY

€ excl. VAT

Wholesaler order number: _____

Name: _____

Contact person: _____

Postal code, town/city: _____

Address: _____

Fax: _____

Tel. no.: _____

Signature: _____

Please note:
The length and width are the actual size of the required shower tray.
It is essential that you include an all-round, 5 mm expansion joint in your planning.
 Article number _____

Length A (see options): _____ mm (Tolerance 0/+1 mm)

Width B (see options): _____ mm (Tolerance 0/+1 mm)

Options: = area that can be cut to size

Colour of shower tray: 1S (Anthracite) 2S (Crème) 3S (Grey) 4S (Brown) RW (Stone White)

Customised dimensions for flush-mounted and surface-mounted installation

Installation position:

Left-hand model (left-hand side is cut and positioned against the wall, flush-mounted or on the floor)

Right-hand version (right side cut and placed against the wall, floor-flush or 40 mm on the floor)

Wall-mounted variant* (flush-mounted or on the floor)

Niche variant (flush-mounted or on the floor)

* With variants on the floor, this length (A) is based on the sizes "Standard models for all installation types" (see page 419)

Measuring special shapes

Installation position:

Please add drawing

Please add drawing

Please add drawing

Size l (A) x w x h	Maximum cutting options (E/F/G)
1800 x 1000	200 / 200 / 300 x 300
1800 x 800	100 / 200 / 300 x 300
1600 x 900	
1600 x 800	
1400 x 900	
1400 x 800	100 / 200 / 300 x 300
1200 x 1200	
1200 x 900	
1200 x 800	100 / 100 / 300 x 300
1000 x 1000	
1000 x 900	
900 x 900	100 / 100 / 300 x 300
900 x 800	

Article number	Price category	Depth (C)	Waste ø	Waste l x w	1S, 2S, 3S, 4S, RW	pcs/pal.
UDQ 1810 SQI 2MV-XX	from 1800 x 1000 mm to 1400 x 700 mm	15	90	200 x 155		1
UDQ 1490 SQI 2MV-XX	from 1400 x 900 mm to 700 x 700 mm					1

Note: Dimensions between 1200 x 1000 mm and 1400 x 1000 mm are not possible.

ARCHITECTURA MetalRim (Square) Acrylic (15 mm)

€ excl. VAT

Included in scope of delivery:

Outlet cover in White Alpine (01), for matt colours, outlet cover in matching matt colours. Depending on the material and light incidence, slight colour deviations may occur between the outlet cover and the shower tray.

Not included in scope of delivery:

All shower trays are supplied without support/base.

With MetalRim and an edge height of 15mm, we recommend the use of a composite seal in accordance with ETAG 022 on the floor structure below the shower tray in order to prevent any moisture from penetrating the floor structure.

Technical information:

The VILBOGRIP anti-slip finish (anti-slip class C) can be ordered for the colour 01.

The installation height of the shower tray can be reduced by 30 mm if the Viega outlet fitting art. no. 634 100 is used. Please note: this outlet fitting does not conform to EN 274.

All shower trays in the Colorline colours are classified as anti-slip class B.

The shower trays in the new colors Colorline are not available for all dimensions.

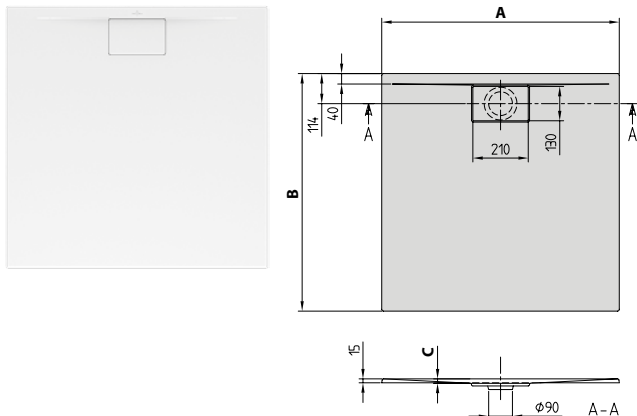

Article number	Name and version	Size l (A) x w	Depth (C)	kg/pc.	01	1S, 2S, 3S, 4S, RW	pcs/pal.
UDA 1010 ARA 115V-XX	Architectura, MetalRim	1000 x 1000	19	15,5			15
UDA 1010 ARA 115GV-01	Architectura, MetalRim, incl. anti slip (VILBOGRIP)			16			15
UDA 9090 ARA 115V-XX	Architectura, MetalRim	900 x 900	17	11			15
UDA 9090 ARA 115GV-01	Architectura, MetalRim, incl. anti slip (VILBOGRIP)						15
UDA 8080 ARA 115V-XX	Architectura, MetalRim	800 x 800	15				15
UDA 8080 ARA 115GV-01	Architectura, MetalRim, incl. anti slip (VILBOGRIP)						15

Accessories for shower trays

Article number	Description	Price
U90881299	Tempoplex Plus outlet, plastic, ø 90 mm, without cover	
U82990000	Shower tray feet, steel, adjustable height 105 to 190 mm	
U91411200	Installation set, for small sizes (800 x 800 - 1000 x 1000), incl. height-adjustable polystyrene rim support, incl. adhesive, incl. sealing tape, incl. 2 polystyrene blocks for floor support, adjustable height 105 to 150 mm	
U9090000010	Fixing foam (non-expanding), for extra-flat installation (without base)	
U91411300	Installation set, for large sizes (1200 x 700 - 1800 x 900), incl. height-adjustable polystyrene rim support, incl. adhesive, incl. sealing tape, incl. 3 polystyrene blocks for floor support, adjustable height 105 to 150 mm	
U91412100	ViFrame installation frame, for smaller shower trays made of ceramic or acrylic (up to 1000 x 1000 mm), incl. 2 central feet	
U91412200	ViFrame installation frame, for larger shower trays made of ceramic or acrylic (from 1000 x 1000 mm), incl. 4 central feet	

XX = Colour code to be indicated

For further information on colours, please see the page at the beginning of this section.

ARCHITECTURA MetalRim (Rectangle) Acrylic (15 mm)

€ excl. VAT

Included in scope of delivery:

Outlet cover in White Alpine (01), for matt colours, outlet cover in matching matt colours. Depending on the material and light incidence, slight colour deviations may occur between the outlet cover and the shower tray.

Not included in scope of delivery:

All shower trays are supplied without support/base.

With MetalRim and an edge height of 15mm, we recommend the use of a composite seal in accordance with ETAG 022 on the floor structure below the shower tray in order to prevent any moisture from penetrating the floor structure.

Technical information:

The VILBOGRIP anti-slip finish (anti-slip class C) can be ordered for the colour 01.

The installation height of the shower tray can be reduced by 30 mm if the Viega outlet fitting art. no. 634 100 is used. Please note: this outlet fitting does not conform to EN 274.

All shower trays in the Colorline colours are classified as anti-slip class B.

From size 1400 x 900 two supports (U82990000) are required.

The shower trays in the new colors Colorline are not available for all dimensions.

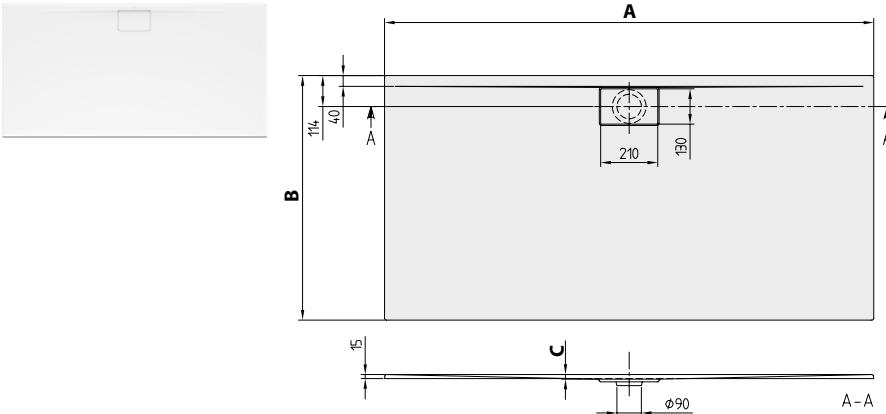

Article number	Name and version	Size l (A) x w	Depth (C)	kg/pc.	01	1S, 2S, 3S, 4S, RW	pcs/pal.
UDA 1890 ARA 215V-XX	Architectura, MetalRim	1800 x 900	17	27			15
UDA 1890 ARA 215GV-01	Architectura, MetalRim, incl. anti slip (VILBOGRIP)			30			15
UDA 1880 ARA 215V-XX	Architectura, MetalRim	1800 x 800	17	24			15
UDA 1880 ARA 215GV-01	Architectura, MetalRim, incl. anti slip (VILBOGRIP)			28			15
UDA 1790 ARA 215V-XX	Architectura, MetalRim	1700 x 900	17	25			15
UDA 1790 ARA 215GV-01	Architectura, MetalRim, incl. anti slip (VILBOGRIP)			29			15
UDA 1780 ARA 215V-XX	Architectura, MetalRim	1700 x 800	16	23			15
UDA 1780 ARA 215GV-01	Architectura, MetalRim, incl. anti slip (VILBOGRIP)			24			15
UDA 1775 ARA 215V-XX	Architectura, MetalRim	1700 x 750	16	21			15
UDA 1775 ARA 215GV-01	Architectura, MetalRim, incl. anti slip (VILBOGRIP)						15
UDA 1770 ARA 215V-XX	Architectura, MetalRim	1700 x 700	16	20			15
UDA 1770 ARA 215GV-01	Architectura, MetalRim, incl. anti slip (VILBOGRIP)			18			15
UDA 1690 ARA 215V-XX	Architectura, MetalRim	1600 x 900	17	24			15
UDA 1690 ARA 215GV-01	Architectura, MetalRim, incl. anti slip (VILBOGRIP)			27			15
UDA 1680 ARA 215V-XX	Architectura, MetalRim	1600 x 800	15	21			15
UDA 1680 ARA 215GV-01	Architectura, MetalRim, incl. anti slip (VILBOGRIP)			22			15
UDA 1675 ARA 215V-XX	Architectura, MetalRim	1600 x 750	15	20			15
UDA 1675 ARA 215GV-01	Architectura, MetalRim, incl. anti slip (VILBOGRIP)						
UDA 1670 ARA 215V-XX	Architectura, MetalRim	1600 x 700	15	20			15
UDA 1670 ARA 215GV-01	Architectura, MetalRim, incl. anti slip (VILBOGRIP)						

Accessories for shower trays

Article number	Description	Price
U90881299	Tempoplex Plus outlet, plastic, ø 90 mm, without cover	
U82990000	Shower tray feet, steel, adjustable height 105 to 190 mm	
U91411200	Installation set, for small sizes (800 x 800 - 1000 x 1000), incl. height-adjustable polystyrene rim support, incl. adhesive, incl. sealing tape, incl. 2 polystyrene blocks for floor support, adjustable height 105 to 150 mm	
U909000010	Fixing foam (non-expanding), for extra-flat installation (without base)	
U91411300	Installation set, for large sizes (1200 x 700 - 1800 x 900), incl. height-adjustable polystyrene rim support, incl. adhesive, incl. sealing tape, incl. 3 polystyrene blocks for floor support, adjustable height 105 to 150 mm	
U91412100	ViFrame installation frame, for smaller shower trays made of ceramic or acrylic (up to 1000 x 1000 mm), incl. 2 central feet	
U91412200	ViFrame installation frame, for larger shower trays made of ceramic or acrylic (from 1000 x 1000 mm), incl. 4 central feet	

XX = Colour code to be indicated

For further information on colours, please see the page at the beginning of this section.

ARCHITECTURA MetalRim (Rectangle) Acrylic (15 mm)

€ excl. VAT

Included in scope of delivery:

Outlet cover in White Alpine (01), for matt colours, outlet cover in matching matt colours. Depending on the material and light incidence, slight colour deviations may occur between the outlet cover and the shower tray.

Not included in scope of delivery:

All shower trays are supplied without support/base.

With MetalRim and an edge height of 15mm, we recommend the use of a composite seal in accordance with ETAG 022 on the floor structure below the shower tray in order to prevent any moisture from penetrating the floor structure.

Technical information:

The VILBOGRIP anti-slip finish (anti-slip class C) can be ordered for the colour 01.

The installation height of the shower tray can be reduced by 30 mm if the Viega outlet fitting art. no. 634 100 is used. Please note: this outlet fitting does not conform to EN 274.

All shower trays in the Colorline colours are classified as anti-slip class B.

From size 1400 x 900 two supports (U82990000) are required.

The shower trays in the new colors Colorline are not available for all dimensions.

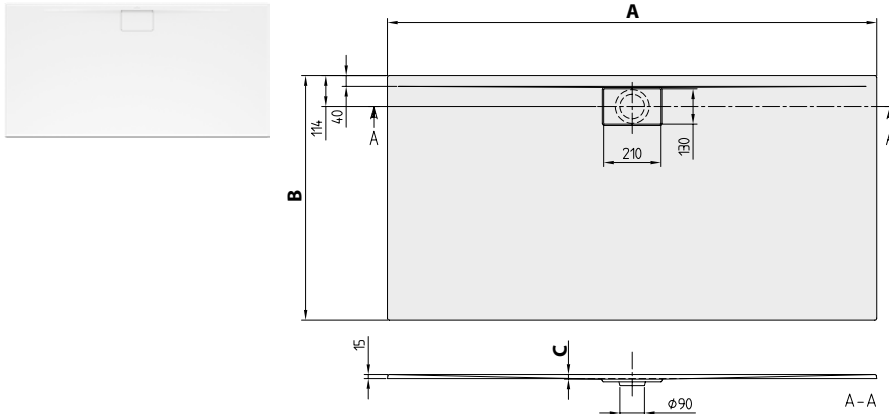

Article number	Name and version	Size l (A) x w	Depth (C)	kg/pc.	01	1S, 2S, 3S, 4S, RW	pcs/pal.
UDA 1510 ARA 215V-XX	Architectura, MetalRim	1500 x 1000	19	25			15
UDA 1510 ARA 215GV-01	Architectura, MetalRim, incl. anti slip (VILBOGRIP)			28			15
UDA 1590 ARA 215V-XX	Architectura, MetalRim	1500 x 900	17	23			15
UDA 1590 ARA 215GV-01	Architectura, MetalRim, incl. anti slip (VILBOGRIP)			25			15
UDA 1580 ARA 215V-XX	Architectura, MetalRim	1500 x 800	15	20			15
UDA 1580 ARA 215GV-01	Architectura, MetalRim, incl. anti slip (VILBOGRIP)			21			15
UDA 1490 ARA 215V-XX	Architectura, MetalRim	1400 x 900	17	17			15
UDA 1490 ARA 215GV-01	Architectura, MetalRim, incl. anti slip (VILBOGRIP)			22			15
UDA 1480 ARA 215V-XX	Architectura, MetalRim	1400 x 800	15	17			15
UDA 1480 ARA 215GV-01	Architectura, MetalRim, incl. anti slip (VILBOGRIP)			21			15
UDA 1475 ARA 215V-XX	Architectura, MetalRim	1400 x 750	14	17			15
UDA 1475 ARA 215GV-01	Architectura, MetalRim, incl. anti slip (VILBOGRIP)			18			15
UDA 1470 ARA 215V-XX	Architectura, MetalRim	1400 x 700	13	17,5			15
UDA 1470 ARA 215GV-01	Architectura, MetalRim, incl. anti slip (VILBOGRIP)			17			15
UDA 1290 ARA 215V-XX	Architectura, MetalRim	1200 x 900	17	16,5			15
UDA 1290 ARA 215GV-01	Architectura, MetalRim, incl. anti slip (VILBOGRIP)			19			15
UDA 1280 ARA 215V-XX	Architectura, MetalRim	1200 x 800	15	16			15
UDA 1280 ARA 215GV-01	Architectura, MetalRim, incl. anti slip (VILBOGRIP)			18			15
UDA 1275 ARA 215V-XX	Architectura, MetalRim	1200 x 750	14	15			15
UDA 1275 ARA 215GV-01	Architectura, MetalRim, incl. anti slip (VILBOGRIP)						15
UDA 1270 ARA 215V-XX	Architectura, MetalRim	1200 x 700	13	14			15
UDA 1270 ARA 215GV-01	Architectura, MetalRim, incl. anti slip (VILBOGRIP)						15

Accessories for shower trays

Article number	Description	Price
U90881299	Tempoplex Plus outlet, plastic, ø 90 mm, without cover	
U82990000	Shower tray feet, steel, adjustable height 105 to 190 mm	
U91411200	Installation set, for small sizes (800 x 800 - 1000 x 1000), incl. height-adjustable polystyrene rim support, incl. adhesive, incl. sealing tape, incl. 2 polystyrene blocks for floor support, adjustable height 105 to 150 mm	
U909000010	Fixing foam (non-expanding), for extra-flat installation (without base)	
U91411300	Installation set, for large sizes (1200 x 700 - 1800 x 900), incl. height-adjustable polystyrene rim support, incl. adhesive, incl. sealing tape, incl. 3 polystyrene blocks for floor support, adjustable height 105 to 150 mm	
U91412100	ViFrame installation frame, for smaller shower trays made of ceramic or acrylic (up to 1000 x 1000 mm), incl. 2 central feet	
U91412200	ViFrame installation frame, for larger shower trays made of ceramic or acrylic (from 1000 x 1000 mm), incl. 4 central feet	

XX = Colour code to be indicated

For further information on colours, please see the page at the beginning of this section.

ARCHITECTURA MetalRim (Rectangle) Acrylic (15 mm)

€ excl. VAT

Included in scope of delivery: Outlet cover in White Alpine (01), for matt colours, outlet cover in matching matt colours. Depending on the material and light incidence, slight colour deviations may occur between the outlet cover and the shower tray.

Not included in scope of delivery: All shower trays are supplied without support/base. With MetalRim and an edge height of 15mm, we recommend the use of a composite seal in accordance with ETAG 022 on the floor structure below the shower tray in order to prevent any moisture from penetrating the floor structure.

Technical information: The VILBOGRIP anti-slip finish (anti-slip class C) can be ordered for the colour 01. The installation height of the shower tray can be reduced by 30 mm if the Viega outlet fitting art. no. 634 100 is used. Please note: this outlet fitting does not conform to EN 274.

**All shower trays in the Colorline colours are classified as anti-slip class B.
The shower trays in the new colors Colorline are not available for all dimensions.**

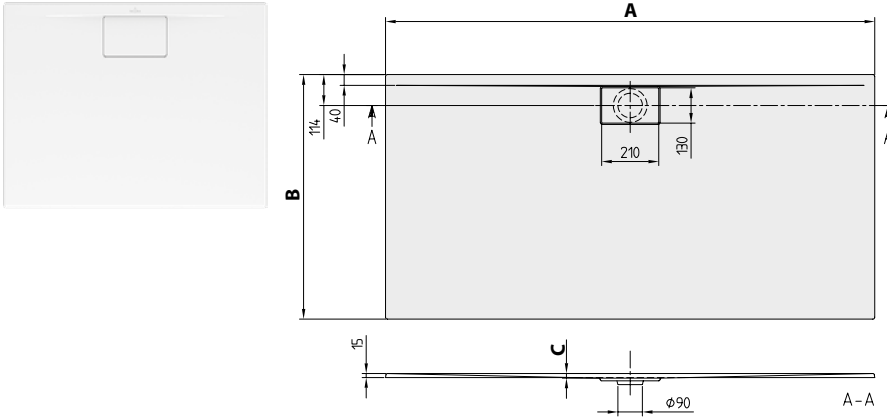

Article number	Name and version	Size l (A) x w	Depth (C)	kg/pc.	01	1S, 2S, 3S, 4S, RW	pcs/pal.
UDA 1090 ARA 215V-XX	Architectura, MetalRim	1000 x 900	17	15			15
UDA 1090 ARA 215GV-01	Architectura, MetalRim, incl. anti slip (VILBOGRIP)						15
UDA 1070 ARA 215V-XX	Architectura, MetalRim	1000 x 700	13	11,5			15
UDA 1070 ARA 215GV-01	Architectura, MetalRim, incl. anti slip (VILBOGRIP)						15
UDA 1080 ARA 215V-XX	Architectura, MetalRim	1000 x 800	15	14			15
UDA 1080 ARA 215GV-01	Architectura, MetalRim, incl. anti slip (VILBOGRIP)						15
UDA 1075 ARA 215V-XX	Architectura, MetalRim	1000 x 750	14	12			15
UDA 1075 ARA 215GV-01	Architectura, MetalRim, incl. anti slip (VILBOGRIP)						15
UDA 9080 ARA 215V-XX	Architectura, MetalRim	900 x 800	15	12			15
UDA 9080 ARA 215GV-01	Architectura, MetalRim, incl. anti slip (VILBOGRIP)						15
UDA 9075 ARA 215V-XX	Architectura, MetalRim	900 x 750	14	11			15
UDA 9075 ARA 215GV-01	Architectura, MetalRim, incl. anti slip (VILBOGRIP)						15
UDA 9070 ARA 215V-XX	Architectura, MetalRim	900 x 700	13	10			15
UDA 9070 ARA 215GV-01	Architectura, MetalRim, incl. anti slip (VILBOGRIP)						15

Accessories for shower trays

Article number	Description	Price
U90881299	Tempoplex Plus outlet, plastic, ø 90 mm, without cover	
U82990000	Shower tray feet, steel, adjustable height 105 to 190 mm	
U91411200	Installation set, for small sizes (800 x 800 - 1000 x 1000), incl. height-adjustable polystyrene rim support, incl. adhesive, incl. sealing tape, incl. 2 polystyrene blocks for floor support, adjustable height 105 to 150 mm	
U9090000010	Fixing foam (non-expanding), for extra-flat installation (without base)	
U91411300	Installation set, for large sizes (1200 x 700 - 1800 x 900), incl. height-adjustable polystyrene rim support, incl. adhesive, incl. sealing tape, incl. 3 polystyrene blocks for floor support, adjustable height 105 to 150 mm	
U91412100	ViFrame installation frame, for smaller shower trays made of ceramic or acrylic (up to 1000 x 1000 mm), incl. 2 central feet	
U91412200	ViFrame installation frame, for larger shower trays made of ceramic or acrylic (from 1000 x 1000 mm), incl. 4 central feet	

XX = Colour code to be indicated
For further information on colours, please see the page at the beginning of this section.

ARCHITECTURA MetalRim (Square) Acrylic (48 mm)

€ excl. VAT

Included in scope of delivery:

Outlet cover in White Alpine (01), for matt colours, outlet cover in matching matt colours. Depending on the material and light incidence, slight colour deviations may occur between the outlet cover and the shower tray.

Not included in scope of delivery:

All shower trays are supplied without support/base.

Technical information:

The VILBOGRIP anti-slip finish (anti-slip class C) can be ordered for the colour 01.

The installation height of the shower tray can be reduced by 30 mm if the Viega outlet fitting art. no. 634 100 is used. Please note: this outlet fitting does not conform to EN 274.

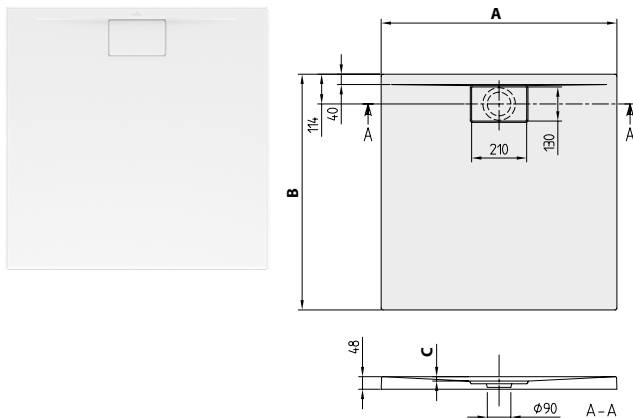
All shower trays in the Colorline colours are classified as anti-slip class B.
The shower trays in the new colors Colorline are not available for all dimensions.

Article number	Name and version	Size l (A) x w	Depth (C)	kg/pc.	01	1S, 2S, 3S, 4S, RW	pcs/pal.
UDA 1010 ARA 148V-XX	Architectura, MetalRim	1000 x 1000	19	18			15
UDA 1010 ARA 148GV-01	Architectura, MetalRim, incl. anti slip (VILBOGRIP)						
UDA 9090 ARA 148V-XX	Architectura, MetalRim	900 x 900	17	12			15
UDA 9090 ARA 148GV-01	Architectura, MetalRim, incl. anti slip (VILBOGRIP)						
UDA 8080 ARA 148V-XX	Architectura, MetalRim	800 x 800	15				15
UDA 8080 ARA 148GV-01	Architectura, MetalRim, incl. anti slip (VILBOGRIP)						

Accessories for shower trays

Article number	Description	Price
U90881299	Tempoplex Plus outlet, plastic, \varnothing 90 mm, without cover	
U82990000	Shower tray feet, steel, adjustable height 105 to 190 mm	
U91411200	Installation set, for small sizes (800 x 800 - 1000 x 1000), incl. height-adjustable polystyrene rim support, incl. adhesive, incl. sealing tape, incl. 2 polystyrene blocks for floor support, adjustable height 105 to 150 mm	
U9090000010	Fixing foam (non-expanding), for extra-flat installation (without base)	
U91411300	Installation set, for large sizes (1200 x 700 - 1800 x 900), incl. height-adjustable polystyrene rim support, incl. adhesive, incl. sealing tape, incl. 3 polystyrene blocks for floor support, adjustable height 105 to 150 mm	
U91412100	ViFrame installation frame, for smaller shower trays made of ceramic or acrylic (up to 1000 x 1000 mm), incl. 2 central feet	
U91412200	ViFrame installation frame, for larger shower trays made of ceramic or acrylic (from 1000 x 1000 mm), incl. 4 central feet	

XX = Colour code to be indicated

For further information on colours, please see the page at the beginning of this section.

ARCHITECTURA MetalRim (Rectangle) Acrylic (48 mm)

€ excl. VAT

Included in scope of delivery:

Outlet cover in White Alpine (01), for matt colours, outlet cover in matching matt colours. Depending on the material and light incidence, slight colour deviations may occur between the outlet cover and the shower tray.

Not included in scope of delivery:

All shower trays are supplied without support/base.

Technical information:

The VILBOGRIP anti-slip finish (anti-slip class C) can be ordered for the colour 01.

The installation height of the shower tray can be reduced by 30 mm if the Viega outlet fitting art. no. 634 100 is used. Please note: this outlet fitting does not conform to EN 274.

All shower trays in the Colorline colours are classified as anti-slip class B.

From size 1400 x 900 two supports (U82990000) are required.

The shower trays in the new colors Colorline are not available for all dimensions.

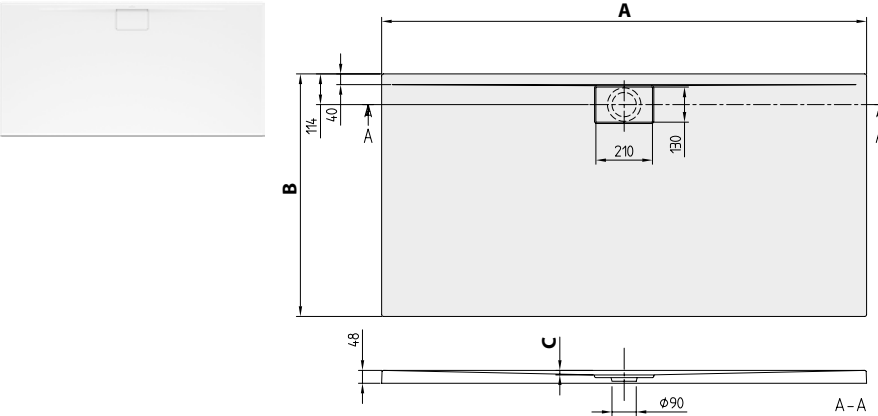

Article number	Name and version	Size l (A) x w	Depth (C)	kg/pc.	01	1S, 2S, 3S, 4S, RW	pcs/pal.
UDA 1890 ARA 248V-XX	Architectura, MetalRim	1800 x 900	17	29,5			15
UDA 1890 ARA 248GV-01	Architectura, MetalRim, incl. anti slip (VILBOGRIP)	1800 x 900		32			15
UDA 1880 ARA 248V-XX	Architectura, MetalRim	1800 x 800		26,5			15
UDA 1880 ARA 248GV-01	Architectura, MetalRim, incl. anti slip (VILBOGRIP)	1800 x 800		30			15
UDA 1790 ARA 248V-XX	Architectura, MetalRim	1700 x 900		27,5			15
UDA 1790 ARA 248GV-01	Architectura, MetalRim, incl. anti slip (VILBOGRIP)	1700 x 900		31			15
UDA 1780 ARA 248V-XX	Architectura, MetalRim	1700 x 800	16	25,5			15
UDA 1780 ARA 248GV-01	Architectura, MetalRim, incl. anti slip (VILBOGRIP)	1700 x 800		26			15
UDA 1775 ARA 248V-XX	Architectura, MetalRim	1700 x 750		23			15
UDA 1775 ARA 248GV-01	Architectura, MetalRim, incl. anti slip (VILBOGRIP)	1700 x 750		20			15
UDA 1770 ARA 248V-XX	Architectura, MetalRim	1700 x 700		22			15
UDA 1770 ARA 248GV-01	Architectura, MetalRim, incl. anti slip (VILBOGRIP)	1700 x 700		20			15
UDA 1690 ARA 248V-XX	Architectura, MetalRim	1600 x 900	15	26,5			15
UDA 1690 ARA 248GV-01	Architectura, MetalRim, incl. anti slip (VILBOGRIP)	1600 x 900		29			15
UDA 1680 ARA 248V-XX	Architectura, MetalRim	1600 x 800		23			15
UDA 1680 ARA 248GV-01	Architectura, MetalRim, incl. anti slip (VILBOGRIP)	1600 x 800		24			15
UDA 1675 ARA 248V-XX	Architectura, MetalRim	1600 x 750		22,5			15
UDA 1675 ARA 248GV-01	Architectura, MetalRim, incl. anti slip (VILBOGRIP)	1600 x 750		22			15
UDA 1670 ARA 248V-XX	Architectura, MetalRim	1600 x 700	15	22			15
UDA 1670 ARA 248GV-01	Architectura, MetalRim, incl. anti slip (VILBOGRIP)	1600 x 700		21			15

Accessories for shower trays

Article number	Description	Price
U90881299	Tempoplex Plus outlet, plastic, ø 90 mm, without cover	
U82990000	Shower tray feet, steel, adjustable height 105 to 190 mm	
U91411200	Installation set, for small sizes (800 x 800 - 1000 x 1000), incl. height-adjustable polystyrene rim support, incl. adhesive, incl. sealing tape, incl. 2 polystyrene blocks for floor support, adjustable height 105 to 150 mm	
U9090000010	Fixing foam (non-expanding), for extra-flat installation (without base)	
U91411300	Installation set, for large sizes (1200 x 700 - 1800 x 900), incl. height-adjustable polystyrene rim support, incl. adhesive, incl. sealing tape, incl. 3 polystyrene blocks for floor support, adjustable height 105 to 150 mm	
U91412100	ViFrame installation frame, for smaller shower trays made of ceramic or acrylic (up to 1000 x 1000 mm), incl. 2 central feet	
U91412200	ViFrame installation frame, for larger shower trays made of ceramic or acrylic (from 1000 x 1000 mm), incl. 4 central feet	

XX = Colour code to be indicated

For further information on colours, please see the page at the beginning of this section.

SHOWER TRAYS

ARCHITECTURA MetalRim (Rectangle) Acrylic (48 mm)

€ excl. VAT

Included in scope of delivery:

Outlet cover in White Alpine (01), for matt colours, outlet cover in matching matt colours. Depending on the material and light incidence, slight colour deviations may occur between the outlet cover and the shower tray.

Not included in scope of delivery:

All shower trays are supplied without support/base.

Technical information:

The VILBOGRIP anti-slip finish (anti-slip class C) can be ordered for the colour 01.

The installation height of the shower tray can be reduced by 30 mm if the Viega outlet fitting art. no. 634 100 is used. Please note: this outlet fitting does not conform to EN 274.

All shower trays in the Colorline colours are classified as anti-slip class B.

From size 1400 x 900 two supports (U82990000) are required.

The shower trays in the new colors Colorline are not available for all dimensions.

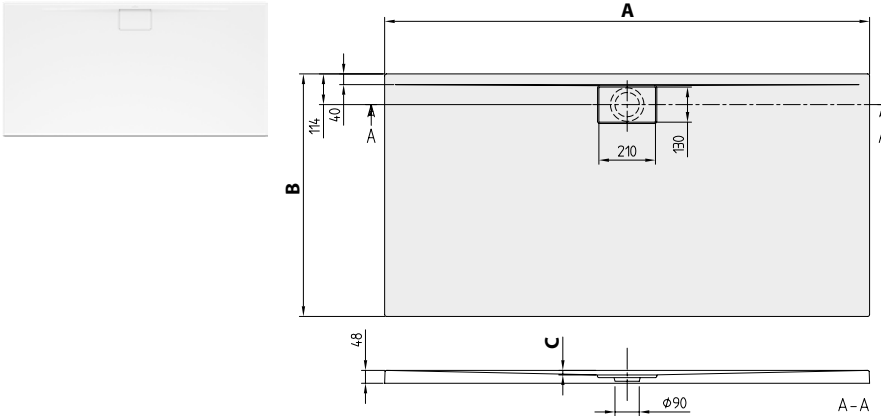

Article number	Name and version	Size l (A) x w	Depth (C)	kg/pc.	01	1S, 2S, 3S, 4S, RW	pcs/pal.
UDA 1510 ARA 248V-XX	Architectura, MetalRim	1500 x 1000	19	27			15
UDA 1510 ARA 248GV-01	Architectura, MetalRim, incl. anti slip (VILBOGRIP)			30			15
UDA 1590 ARA 248V-XX	Architectura, MetalRim	1500 x 900	17	25,5			15
UDA 1590 ARA 248GV-01	Architectura, MetalRim, incl. anti slip (VILBOGRIP)			27			15
UDA 1580 ARA 248V-XX	Architectura, MetalRim	1500 x 800	15	22,5			15
UDA 1580 ARA 248GV-01	Architectura, MetalRim, incl. anti slip (VILBOGRIP)			23			15
UDA 1490 ARA 248V-XX	Architectura, MetalRim	1400 x 900	17	23,5			15
UDA 1490 ARA 248GV-01	Architectura, MetalRim, incl. anti slip (VILBOGRIP)			24			15
UDA 1480 ARA 248V-XX	Architectura, MetalRim	1400 x 800	15	19,5			15
UDA 1480 ARA 248GV-01	Architectura, MetalRim, incl. anti slip (VILBOGRIP)			23			15
UDA 1475 ARA 248V-XX	Architectura, MetalRim	1400 x 750	14	19			15
UDA 1475 ARA 248GV-01	Architectura, MetalRim, incl. anti slip (VILBOGRIP)			20			15
UDA 1470 ARA 248V-XX	Architectura, MetalRim	1400 x 700	13	17,5			15
UDA 1470 ARA 248GV-01	Architectura, MetalRim, incl. anti slip (VILBOGRIP)			19			15
UDA 1290 ARA 248V-XX	Architectura, MetalRim	1200 x 900	17	18,5			15
UDA 1290 ARA 248GV-01	Architectura, MetalRim, incl. anti slip (VILBOGRIP)			21			15
UDA 1280 ARA 248V-XX	Architectura, MetalRim	1200 x 800	15	18			15
UDA 1280 ARA 248GV-01	Architectura, MetalRim, incl. anti slip (VILBOGRIP)			20			15
UDA 1275 ARA 248V-XX	Architectura, MetalRim	1200 x 750	14	17			15
UDA 1275 ARA 248GV-01	Architectura, MetalRim, incl. anti slip (VILBOGRIP)			17			15
UDA 1270 ARA 248V-XX	Architectura, MetalRim	1200 x 700	13	16			15
UDA 1270 ARA 248GV-01	Architectura, MetalRim, incl. anti slip (VILBOGRIP)			16			15

Accessories for shower trays

Article number	Description	Price
U90881299	Tempoplex Plus outlet, plastic, ø 90 mm, without cover	
U82990000	Shower tray feet, steel, adjustable height 105 to 190 mm	
U91411200	Installation set, for small sizes (800 x 800 - 1000 x 1000), incl. height-adjustable polystyrene rim support, incl. adhesive, incl. sealing tape, incl. 2 polystyrene blocks for floor support, adjustable height 105 to 150 mm	
U9090000010	Fixing foam (non-expanding), for extra-flat installation (without base)	
U91411300	Installation set, for large sizes (1200 x 700 - 1800 x 900), incl. height-adjustable polystyrene rim support, incl. adhesive, incl. sealing tape, incl. 3 polystyrene blocks for floor support, adjustable height 105 to 150 mm	
U91412100	ViFrame installation frame, for smaller shower trays made of ceramic or acrylic (up to 1000 x 1000 mm), incl. 2 central feet	
U91412200	ViFrame installation frame, for larger shower trays made of ceramic or acrylic (from 1000 x 1000 mm), incl. 4 central feet	

XX = Colour code to be indicated
For further information on colours, please see the page at the beginning of this section.

SHOWER TRAYS

ARCHITECTURA MetalRim (Rectangle) Acrylic (48 mm)

€ excl. VAT

Included in scope of delivery:

Outlet cover in White Alpine (01), for matt colours, outlet cover in matching matt colours. Depending on the material and light incidence, slight colour deviations may occur between the outlet cover and the shower tray.

Not included in scope of delivery:

All shower trays are supplied without support/base.

Technical information:

The VILBOGRIP anti-slip finish (anti-slip class C) can be ordered for the colour 01.

The installation height of the shower tray can be reduced by 30 mm if the Viega outlet fitting art. no. 634 100 is used. Please note: this outlet fitting does not conform to EN 274.

All shower trays in the Colorline colours are classified as anti-slip class B.

The shower trays in the new colors Colorline are not available for all dimensions.

SHOWER TRAYS

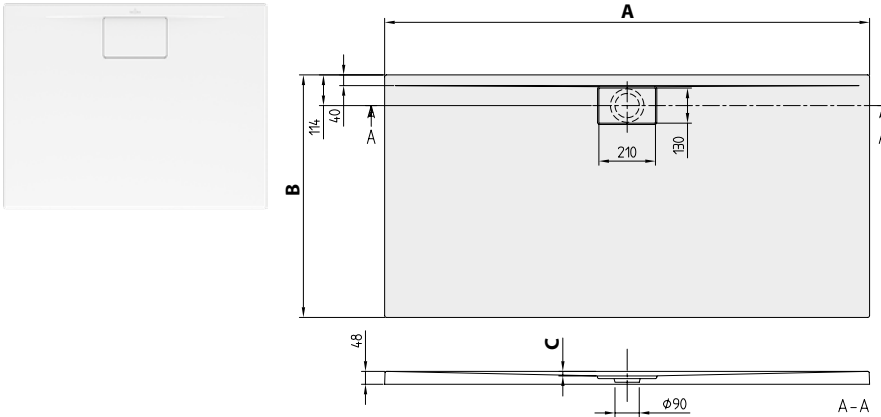

Article number	Name and version	Size l (A) x w	Depth (C)	kg/pc.	01	1S, 2S, 3S, 4S, RW	pcs/pal.
UDA 1090 ARA 248V-XX	Architectura, MetalRim	1000 x 900	17	16,5			15
UDA 1090 ARA 248GV-01	Architectura, MetalRim, incl. anti slip (VILBOGRIP)			17			15
UDA 1080 ARA 248V-XX	Architectura, MetalRim	1000 x 800	15	15			15
UDA 1080 ARA 248GV-01	Architectura, MetalRim, incl. anti slip (VILBOGRIP)						15
UDA 1075 ARA 248V-XX	Architectura, MetalRim	1000 x 750	14	13,5			15
UDA 1075 ARA 248GV-01	Architectura, MetalRim, incl. anti slip (VILBOGRIP)						15
UDA 1070 ARA 248V-XX	Architectura, MetalRim	1000 x 700	13	14			15
UDA 1070 ARA 248GV-01	Architectura, MetalRim, incl. anti slip (VILBOGRIP)						15
UDA 9080 ARA 248V-XX	Architectura, MetalRim	900 x 800	15	13			15
UDA 9080 ARA 248GV-01	Architectura, MetalRim, incl. anti slip (VILBOGRIP)						15
UDA 9075 ARA 248V-XX	Architectura, MetalRim	900 x 750	14	12			15
UDA 9075 ARA 248GV-01	Architectura, MetalRim, incl. anti slip (VILBOGRIP)						15
UDA 9070 ARA 248V-XX	Architectura, MetalRim	900 x 700	13	11			15
UDA 9070 ARA 248GV-01	Architectura, MetalRim, incl. anti slip (VILBOGRIP)						15

Accessories for shower trays

Article number	Description	Price
U90881299	Tempoplex Plus outlet, plastic, ø 90 mm, without cover	
U82990000	Shower tray feet, steel, adjustable height 105 to 190 mm	
U91411200	Installation set, for small sizes (800 x 800 - 1000 x 1000), incl. height-adjustable polystyrene rim support, incl. adhesive, incl. sealing tape, incl. 2 polystyrene blocks for floor support, adjustable height 105 to 150 mm	
U9090000010	Fixing foam (non-expanding), for extra-flat installation (without base)	
U91411300	Installation set, for large sizes (1200 x 700 - 1800 x 900), incl. height-adjustable polystyrene rim support, incl. adhesive, incl. sealing tape, incl. 3 polystyrene blocks for floor support, adjustable height 105 to 150 mm	
U91412100	ViFrame installation frame, for smaller shower trays made of ceramic or acrylic (up to 1000 x 1000 mm), incl. 2 central feet	
U91412200	ViFrame installation frame, for larger shower trays made of ceramic or acrylic (from 1000 x 1000 mm), incl. 4 central feet	

XX = Colour code to be indicated
For further information on colours, please see the page at the beginning of this section.

PLANEO SHOWER TRAYS WITH ROCKLITE TECHNOLOGY

€ excl. VAT

True innovations are rare. However, this shower tray will leave a lasting impression on both you and your customers: thanks to the unique RockLite technology, Planeo is extremely stable yet so light that it can be carried and installed by just one person. The combination of high-quality sanitary acrylic and polyurethane, a robust supporting material, provides a safe and secure feeling underfoot and is pleasant to the touch. And its timeless minimalist design is perfect for any bathroom.



SHOWER TRAYS

Unique and innovative material composition

- Excellent stability yet light (on average 50% lighter than comparable mineral cast shower trays) thanks to the new and innovative RockLite technology
- Maximum robustness and easy to clean
- UV- and temperature-resistant and repairable surface
- High comfort/good tactile properties for a pleasant feeling underfoot
- Antislip class B for matt colours
- Antislip class C in combination with Vibogrip for the colour 01
- Drainage rate with PURE METAL or PURE WHITE outlet cover of 51 l/min is well above standard

Minimalist, delicate design

- Ultra-flat, rimless look (40 mm or 48 mm rim height)
- Integrated flush-fit square outlet cover positioned on the short side of the shower tray: easy to clean and replace

Surprisingly distinctive

- In addition to the standard colours, for the first time now also available in 5 trendy StoneLook colours



STONELOOK COLOURS



COLORLINE

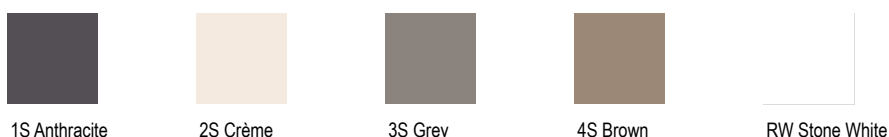

GLOSSY COLOURS



PLANEО SHOWER TRAYS WITH ROCKLITE TECHNOLOGY

€ excl. VAT

- Available in the standard Villeroy & Boch matt and glossy colours
- Selection of 12 individual, flush-fitting outlet covers in brushed stainless steel for special highlights



- Closed outlet cover "Pure Metal" included in the scope of delivery
- 26 different sizes between 80x80cm and 180x100cm
- Can be cut on site

Easy and fast installation without any unpleasant surprises

- 3 installation variants for maximum flexibility: floor-flush installation, installation on tiles, installation on skirting
- No installation frame needed for surface-mounted installation

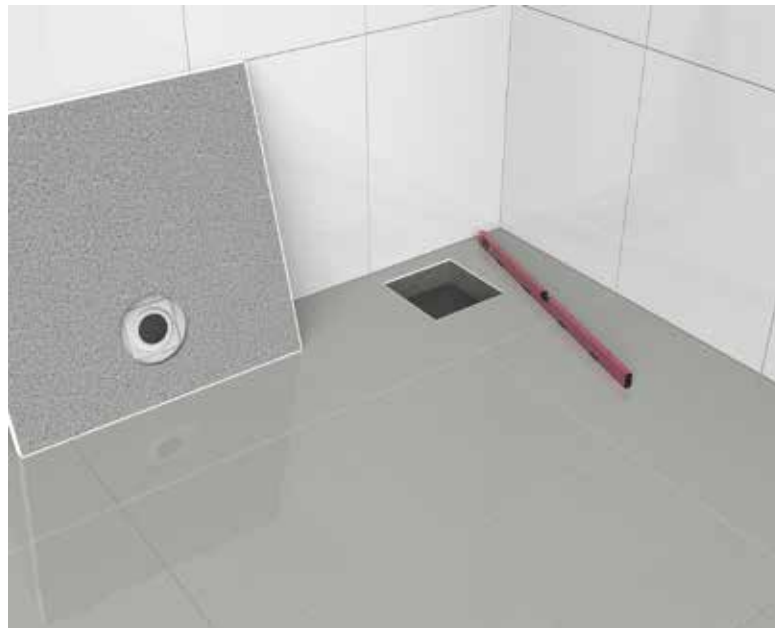

PLANE0 (Square) Acrylic (standard models for all installation types)

€ excl. VAT

Included in scope of delivery:

Outlet cover "Pure Metal" in brushed stainless steel

Not included in scope of delivery:

All shower trays are supplied without support/base.

Technical information:

Can be cut to size on site.

The VILBOGRIP anti-slip finish (anti-slip class C) can be ordered for the colour 01.

All shower trays in ColorLine colours are classified as anti-slip class B. StoneLook colours are classified as anti-slip class A. The colour White is classified as anti-slip class A.

The RockLite shower trays can be cut to size in accordance with the installation instructions; the grey area in the technical drawing represents the area that can be cut. With the cut side against the wall, it can also be installed as a surface-mounted variant. Otherwise only suitable for flush-fit installation after cutting!

Shower tray, stepless access

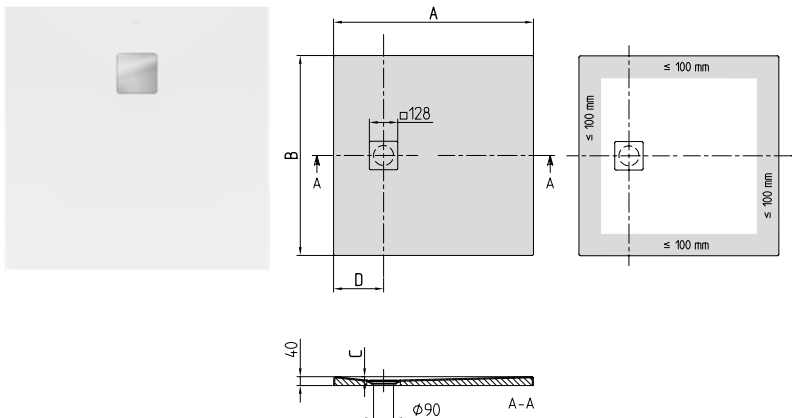

Article number	Name and version	Size l (A) x w	Waste size D	Depth (C)	kg/pc.	01	1S, 2S, 3S, 4S, RW	1N, 2N, 3N, 4N, 5N	pcs/pal.
UDA 1010 PLA 1V-XX	Planeo	1000 x 1000	250	15	19				15
UDA 1010 PLA 1GV-01	Planeo, incl. anti slip (VILBOGRIP)							15	
UDA 9090 PLA 1V-XX	Planeo	900 x 900	225		15,5				15
UDA 9090 PLA 1GV-01	Planeo, incl. anti slip (VILBOGRIP)							15	
UDA 8080 PLA 1V-XX	Planeo	800 x 800	200		12				15
UDA 8080 PLA 1GV-01	Planeo, incl. anti slip (VILBOGRIP)							15	

Accessories for shower trays

Article number	Description	Price
U90881299	Tempoplex Plus outlet, plastic, ø 90 mm, without cover	
UCWAS0290-69	Outlet cover "Pure Metal" in brushed stainless steel, Brushed Chrome	
UCWAS0290-01	Outlet cover "Pure White" in brushed stainless steel, White	
UCWAS0290G-01	Outlet cover "Pure White" in brushed stainless steel, White	
UCWAS0290-1N	Outlet cover "Pure Anthracite" in brushed stainless steel, Nature Anthracite	
UCWAS0290-2N	Outlet cover "Pure Creme" in brushed stainless steel, Nature Creme	
UCWAS0290-3N	Outlet cover "Pure Grey" in brushed stainless steel, Nature Grey	
UCWAS0290-4N	Outlet cover "Pure Sand" in brushed stainless steel, Nature Sand	
UCWAS0290-5N	Outlet cover "Pure Stone White" in brushed stainless steel, Nature White	
UCWAS0290-1S	Outlet cover in brushed stainless steel, Anthracite	
UCWAS0290-2S	Outlet cover in brushed stainless steel, Crème	
UCWAS0290-3S	Outlet cover in brushed stainless steel, Grey	
UCWAS0290-4S	Outlet cover in brushed stainless steel, Brown	
UCWAS0290-RW	Outlet cover in brushed stainless steel, Stone White	
U91411200	Installation set, for small sizes (800 x 800 - 1000 x 1000), incl. height-adjustable polystyrene rim support, incl. adhesive, incl. sealing tape, incl. 2 polystyrene blocks for floor support, adjustable height 105 to 150 mm	
U91411300	Installation set, for large sizes (1200 x 700 - 1800 x 900), incl. height-adjustable polystyrene rim support, incl. adhesive, incl. sealing tape, incl. 3 polystyrene blocks for floor support, adjustable height 105 to 150 mm	
U82400001	Sealing tape	
U91412100	ViFrame installation frame, for smaller shower trays made of ceramic or acrylic (up to 1000 x 1000 mm), incl. 2 central feet	
U91412200	ViFrame installation frame, for larger shower trays made of ceramic or acrylic (from 1000 x 1000 mm), incl. 4 central feet	

XX = Colour code to be indicated

For further information on colours, please see the page at the beginning of this section.

PLANE0 (Rectangle) Acrylic (standard models for all installation types)

€ excl. VAT

Included in scope of delivery:

Outlet cover "Pure Metal" in brushed stainless steel

Not included in scope of delivery:

All shower trays are supplied without support/base.

Technical information:

Can be cut to size on site.

The VILBOGRIP anti-slip finish (anti-slip class C) can be ordered for the colour 01.

All shower trays in ColorLine colours are classified as anti-slip class B. StoneLook colours are classified as anti-slip class A. The colour White is classified as anti-slip class A.

The RockLite shower trays can be cut to size in accordance with the installation instructions; the grey area in the technical drawing represents the area that can be cut. With the cut side against the wall, it can also be installed as a surface-mounted variant. Otherwise only suitable for flush-fit installation after cutting!

Shower tray, stepless access

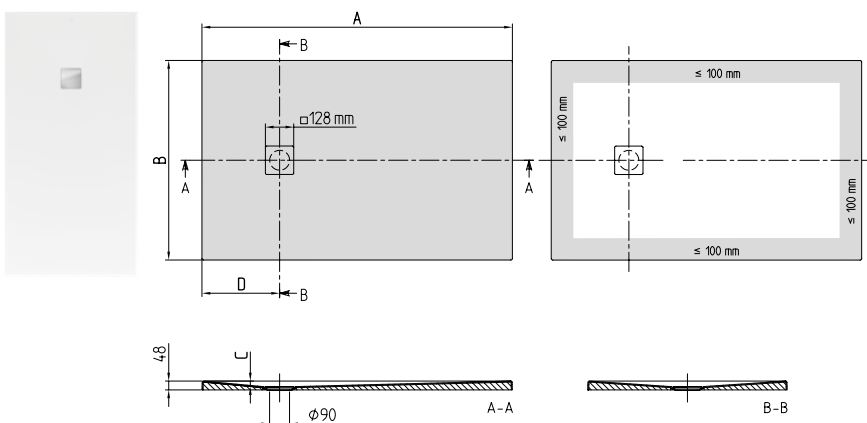

Article number	Name and version	Size l (A) x w	Waste size D	Depth (C)	kg/pc.	01	1S, 2S, 3S, 4S, RW	1N, 2N, 3N, 4N, 5N	pcs/pal.
UDA 1810 PLA 2V-XX	Planeo	1800 x 1000	450	29	34,5				15
UDA 1810 PLA 2GV-01	Planeo, incl. anti slip (VILBOGRIP)			30					15
UDA 1890 PLA 2V-XX	Planeo	1800 x 900	450	30	31				15
UDA 1890 PLA 2GV-01	Planeo, incl. anti slip (VILBOGRIP)								15
UDA 1880 PLA 2V-XX	Planeo	1800 x 800	450	30	27,5				15
UDA 1880 PLA 2GV-01	Planeo, incl. anti slip (VILBOGRIP)								15
UDA 1790 PLA 2V-XX	Planeo	1700 x 900	425	29	29,5				15
UDA 1790 PLA 2GV-01	Planeo, incl. anti slip (VILBOGRIP)			27					15
UDA 1780 PLA 2V-XX	Planeo	1700 x 800	425	27	26				15
UDA 1780 PLA 2GV-01	Planeo, incl. anti slip (VILBOGRIP)								15

Accessories for shower trays

Article number	Description	Price
U90881299	Tempoplex Plus outlet, plastic, ø 90 mm, without cover	
UCWAS0290-01	Outlet cover "Pure White" in brushed stainless steel, White	
UCWAS0290-69	Outlet cover "Pure Metal" in brushed stainless steel, Brushed Chrome	
UCWAS0290-G-01	Outlet cover "Pure White" in brushed stainless steel, White	
UCWAS0290-1N	Outlet cover "Pure Anthracite" in brushed stainless steel, Nature Anthracite	
UCWAS0290-2N	Outlet cover "Pure Creme" in brushed stainless steel, Nature Creme	
UCWAS0290-3N	Outlet cover "Pure Grey" in brushed stainless steel, Nature Grey	
UCWAS0290-4N	Outlet cover "Pure Sand" in brushed stainless steel, Nature Sand	
UCWAS0290-5N	Outlet cover "Pure Stone White" in brushed stainless steel, Nature White	
UCWAS0290-1S	Outlet cover in brushed stainless steel, Anthracite	
UCWAS0290-2S	Outlet cover in brushed stainless steel, Crème	
UCWAS0290-3S	Outlet cover in brushed stainless steel, Grey	
UCWAS0290-4S	Outlet cover in brushed stainless steel, Brown	
UCWAS0290-RW	Outlet cover in brushed stainless steel, Stone White	
U91411200	Installation set, for small sizes (800 x 800 - 1000 x 1000), incl. height-adjustable polystyrene rim support, incl. adhesive, incl. sealing tape, incl. 2 polystyrene blocks for floor support, adjustable height 105 to 150 mm	
U91411300	Installation set, for large sizes (1200 x 700 - 1800 x 900), incl. height-adjustable polystyrene rim support, incl. adhesive, incl. sealing tape, incl. 3 polystyrene blocks for floor support, adjustable height 105 to 150 mm	
U82400001	Sealing tape	
U91412100	ViFrame installation frame, for smaller shower trays made of ceramic or acrylic (up to 1000 x 1000 mm), incl. 2 central feet	
U91412200	ViFrame installation frame, for larger shower trays made of ceramic or acrylic (from 1000 x 1000 mm), incl. 4 central feet	

XX = Colour code to be indicated

For further information on colours, please see the page at the beginning of this section.

PLANEÓ (Rectangle) Acrylic (standard models for all installation types)

€ excl. VAT

Included in scope of delivery:
Not included in scope of delivery:
Technical information:

Outlet cover "Pure Metal" in brushed stainless steel
 All shower trays are supplied without support/base.
 Can be cut to size on site.
 The VILBOGRIP anti-slip finish (anti-slip class C) can be ordered for the colour 01.
All shower trays in ColorLine colours are classified as anti-slip class B. StoneLook colours are classified as anti-slip class A. The colour White is classified as anti-slip class A.
 The RockLite shower trays can be cut to size in accordance with the installation instructions; the grey area in the technical drawing represents the area that can be cut. With the cut side against the wall, it can also be installed as a surface-mounted variant. Otherwise only suitable for flush-fit installation after cutting!
 Shower tray, stepless access

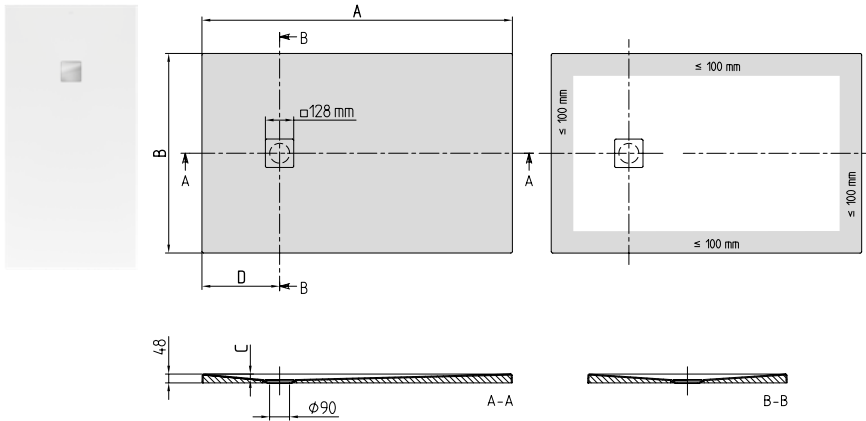

Article number	Name and version	Size l (A) x w	Waste size D	Depth (C)	kg/pc.	01	1S, 2S, 3S, 4S, RW	1N, 2N, 3N, 4N, 5N	pcs/pal.
UDA 1610 PLA 2V-XX	Planeo	1600 x 1000	400	28	30,5				15
UDA 1610 PLA 2GV-01	Planeo, incl. anti slip (VILBOGRIP)								15
UDA 1690 PLA 2V-XX	Planeo	1600 x 900		27	27,5				15
UDA 1690 PLA 2GV-01	Planeo, incl. anti slip (VILBOGRIP)							15	
UDA 1680 PLA 2V-XX	Planeo	1600 x 800		25	24,5				15
UDA 1680 PLA 2GV-01	Planeo, incl. anti slip (VILBOGRIP)							15	
UDA 1510 PLA 2V-XX	Planeo	1500 x 1000	375	24	28,5				15
UDA 1510 PLA 2GV-01	Planeo, incl. anti slip (VILBOGRIP)							15	
UDA 1590 PLA 2V-XX	Planeo	1500 x 900		25	26				15
UDA 1590 PLA 2GV-01	Planeo, incl. anti slip (VILBOGRIP)							15	
UDA 1580 PLA 2V-XX	Planeo	1500 x 800		24	23				15
UDA 1580 PLA 2GV-01	Planeo, incl. anti slip (VILBOGRIP)							15	

Accessories for shower trays

Article number	Description	Price
U90881299	Tempoplex Plus outlet, plastic, ø 90 mm, without cover	
UCWAS0290-01	Outlet cover "Pure White" in brushed stainless steel, White	
UCWAS0290-69	Outlet cover "Pure Metal" in brushed stainless steel, Brushed Chrome	
UCWAS0290G-01	Outlet cover "Pure White" in brushed stainless steel, White	
UCWAS0290-1N	Outlet cover "Pure Anthracite" in brushed stainless steel, Nature Anthracite	
UCWAS0290-2N	Outlet cover "Pure Creme" in brushed stainless steel, Nature Creme	
UCWAS0290-3N	Outlet cover "Pure Grey" in brushed stainless steel, Nature Grey	
UCWAS0290-4N	Outlet cover "Pure Sand" in brushed stainless steel, Nature Sand	
UCWAS0290-5N	Outlet cover "Pure Stone White" in brushed stainless steel, Nature White	
UCWAS0290-1S	Outlet cover in brushed stainless steel, Anthracite	
UCWAS0290-2S	Outlet cover in brushed stainless steel, Crème	
UCWAS0290-3S	Outlet cover in brushed stainless steel, Grey	
UCWAS0290-4S	Outlet cover in brushed stainless steel, Brown	
UCWAS0290-RW	Outlet cover in brushed stainless steel, Stone White	
U91411200	Installation set, for small sizes (800 x 800 - 1000 x 1000), incl. height-adjustable polystyrene rim support, incl. adhesive, incl. sealing tape, incl. 2 polystyrene blocks for floor support, adjustable height 105 to 150 mm	
U91411300	Installation set, for large sizes (1200 x 700 - 1800 x 900), incl. height-adjustable polystyrene rim support, incl. adhesive, incl. sealing tape, incl. 3 polystyrene blocks for floor support, adjustable height 105 to 150 mm	
U82400001	Sealing tape	
U91412100	ViFrame installation frame, for smaller shower trays made of ceramic or acrylic (up to 1000 x 1000 mm), incl. 2 central feet	
U91412200	ViFrame installation frame, for larger shower trays made of ceramic or acrylic (from 1000 x 1000 mm), incl. 4 central feet	

XX = Colour code to be indicated
 For further information on colours, please see the page at the beginning of this section.

PLANE0 (Rectangle) Acrylic (standard models for all installation types)

€ excl. VAT

Included in scope of delivery:
Not included in scope of delivery:
Technical information:

Outlet cover "Pure Metal" in brushed stainless steel
 All shower trays are supplied without support/base.
 Can be cut to size on site.
 The VILBOGRIP anti-slip finish (anti-slip class C) can be ordered for the colour 01.
All shower trays in ColorLine colours are classified as anti-slip class B. StoneLook colours are classified as anti-slip class A. The colour White is classified as anti-slip class A.
 The RockLite shower trays can be cut to size in accordance with the installation instructions; the grey area in the technical drawing represents the area that can be cut. With the cut side against the wall, it can also be installed as a surface-mounted variant. Otherwise only suitable for flush-fit installation after cutting!
 Shower tray, stepless access

SHOWER TRAYS

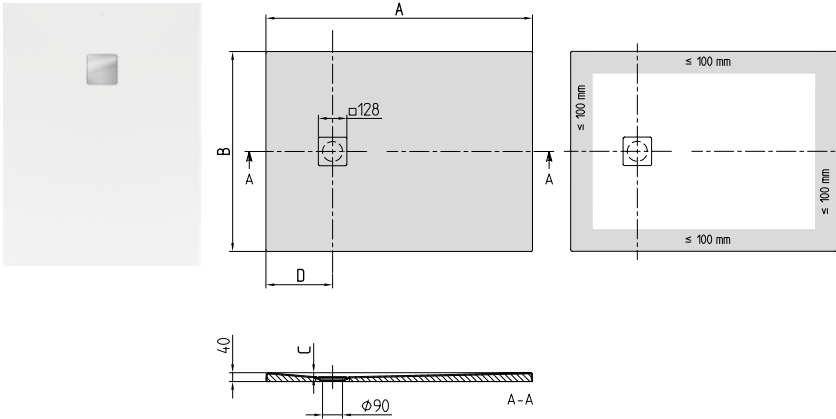

Article number	Name and version	Size l (A) x w	Waste size D	Depth (C)	kg/pc.	01	1S, 2S, 3S, 4S, RW	1N, 2N, 3N, 4N, 5N	pcs/pal.
UDA 1410 PLA 2V-XX	Planeo	1400 x 1000	350	23	27				15
UDA 1410 PLA 2GV-01	Planeo, incl. anti slip (VILBOGRIP)								15
UDA 1490 PLA 2V-XX	Planeo	1400 x 900	350	22	24				15
UDA 1490 PLA 2GV-01	Planeo, incl. anti slip (VILBOGRIP)								15
UDA 1480 PLA 2V-XX	Planeo	1400 x 800	350	21	21,5				15
UDA 1480 PLA 2GV-01	Planeo, incl. anti slip (VILBOGRIP)								15
UDA 1475 PLA 2V-XX	Planeo	1400 x 750	350	21	20				15
UDA 1475 PLA 2GV-01	Planeo, incl. anti slip (VILBOGRIP)								15
UDA 1290 PLA 2V-XX	Planeo	1200 x 900	300	19	20,5				15
UDA 1290 PLA 2GV-01	Planeo, incl. anti slip (VILBOGRIP)								15
UDA 1280 PLA 2V-XX	Planeo	1200 x 800	300	18	15,5				15
UDA 1280 PLA 2GV-01	Planeo, incl. anti slip (VILBOGRIP)								15
UDA 1275 PLA 2V-XX	Planeo	1200 x 750	300	15	17				15
UDA 1275 PLA 2GV-01	Planeo, incl. anti slip (VILBOGRIP)								15

Accessories for shower trays

Article number	Description	Price
U90881299	Tempoplex Plus outlet, plastic, ø 90 mm, without cover	
UCWAS0290-01	Outlet cover "Pure White" in brushed stainless steel, White	
UCWAS0290-69	Outlet cover "Pure Metal" in brushed stainless steel, Brushed Chrome	
UCWAS0290G-01	Outlet cover "Pure White" in brushed stainless steel, White	
UCWAS0290-1N	Outlet cover "Pure Anthracite" in brushed stainless steel, Nature Anthracite	
UCWAS0290-2N	Outlet cover "Pure Creme" in brushed stainless steel, Nature Creme	
UCWAS0290-3N	Outlet cover "Pure Grey" in brushed stainless steel, Nature Grey	
UCWAS0290-4N	Outlet cover "Pure Sand" in brushed stainless steel, Nature Sand	
UCWAS0290-5N	Outlet cover "Pure Stone White" in brushed stainless steel, Nature White	
UCWAS0290-1S	Outlet cover in brushed stainless steel, Anthracite	
UCWAS0290-2S	Outlet cover in brushed stainless steel, Crème	
UCWAS0290-3S	Outlet cover in brushed stainless steel, Grey	
UCWAS0290-4S	Outlet cover in brushed stainless steel, Brown	
UCWAS0290-RW	Outlet cover in brushed stainless steel, Stone White	
U91411200	Installation set, for small sizes (800 x 800 - 1000 x 1000), incl. height-adjustable polystyrene rim support, incl. adhesive, incl. sealing tape, incl. 2 polystyrene blocks for floor support, adjustable height 105 to 150 mm	
U91411300	Installation set, for large sizes (1200 x 700 - 1800 x 900), incl. height-adjustable polystyrene rim support, incl. adhesive, incl. sealing tape, incl. 3 polystyrene blocks for floor support, adjustable height 105 to 150 mm	
U82400001	Sealing tape	
U91412100	ViFrame installation frame, for smaller shower trays made of ceramic or acrylic (up to 1000 x 1000 mm), incl. 2 central feet	
U91412200	ViFrame installation frame, for larger shower trays made of ceramic or acrylic (from 1000 x 1000 mm), incl. 4 central feet	

XX = Colour code to be indicated
 For further information on colours, please see the page at the beginning of this section.

PLANEØ (Rectangle) Acrylic (standard models for all installation types)

€ excl. VAT

Included in scope of delivery:

Outlet cover "Pure Metal" in brushed stainless steel

Not included in scope of delivery:

All shower trays are supplied without support/base.

Technical information:

Can be cut to size on site.

The VILBOGRIP anti-slip finish (anti-slip class C) can be ordered for the colour 01.

All shower trays in ColorLine colours are classified as anti-slip class B. StoneLook colours are classified as anti-slip class A. The colour White is classified as anti-slip class A.

The RockLite shower trays can be cut to size in accordance with the installation instructions; the grey area in the technical drawing represents the area that can be cut. With the cut side against the wall, it can also be installed as a surface-mounted variant. Otherwise only suitable for flush-fit installation after cutting!

Shower tray, stepless access

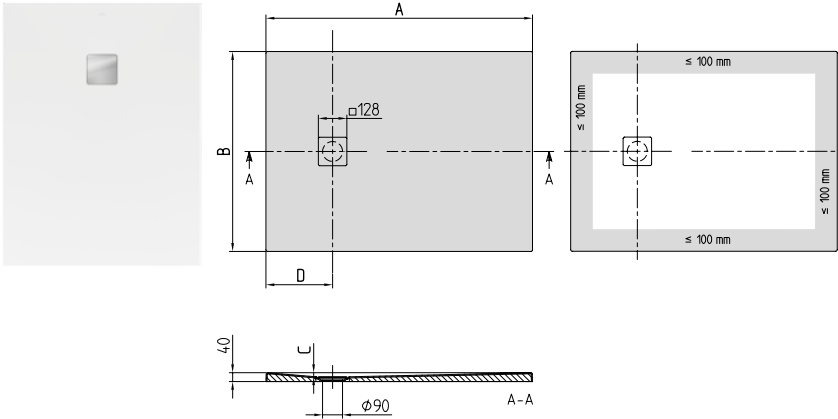

Article number	Name and version	Size l (A) x w	Waste size D	Depth (C)	kg/pc.	01	1S, 2S, 3S, 4S, RW	1N, 2N, 3N, 4N, 5N	pcs/pal.
UDA 1090 PLA 2V-XX	Planeo	1000 x 900	250	15	17				15
UDA 1090 PLA 2GV-01	Planeo, incl. anti slip (VILBOGRIP)								
UDA 1080 PLA 2V-XX	Planeo	1000 x 800	250	15	15,5				15
UDA 1080 PLA 2GV-01	Planeo, incl. anti slip (VILBOGRIP)								
UDA 1075 PLA 2V-XX	Planeo	1000 x 750	250	15	14,5				15
UDA 1075 PLA 2GV-01	Planeo, incl. anti slip (VILBOGRIP)								
UDA 9080 PLA 2V-XX	Planeo	900 x 800	225	14	14				15
UDA 9080 PLA 2GV-01	Planeo, incl. anti slip (VILBOGRIP)								
UDA 9075 PLA 2V-XX	Planeo	900 x 750	225	14	13				15
UDA 9075 PLA 2GV-01	Planeo, incl. anti slip (VILBOGRIP)								

Accessories for shower trays

Article number	Description	Price
U90881299	Tempoplex Plus outlet, plastic, ø 90 mm, without cover	
UCWAS0290-01	Outlet cover "Pure White" in brushed stainless steel, White	
UCWAS0290-69	Outlet cover "Pure Metal" in brushed stainless steel, Brushed Chrome	
UCWAS0290-G-01	Outlet cover "Pure White" in brushed stainless steel, White	
UCWAS0290-1N	Outlet cover "Pure Anthracite" in brushed stainless steel, Nature Anthracite	
UCWAS0290-2N	Outlet cover "Pure Creme" in brushed stainless steel, Nature Creme	
UCWAS0290-3N	Outlet cover "Pure Grey" in brushed stainless steel, Nature Grey	
UCWAS0290-4N	Outlet cover "Pure Sand" in brushed stainless steel, Nature Sand	
UCWAS0290-5N	Outlet cover "Pure Stone White" in brushed stainless steel, Nature White	
UCWAS0290-1S	Outlet cover in brushed stainless steel, Anthracite	
UCWAS0290-2S	Outlet cover in brushed stainless steel, Crème	
UCWAS0290-3S	Outlet cover in brushed stainless steel, Grey	
UCWAS0290-4S	Outlet cover in brushed stainless steel, Brown	
UCWAS0290-RW	Outlet cover in brushed stainless steel, Stone White	
U91411200	Installation set, for small sizes (800 x 800 - 1000 x 1000), incl. height-adjustable polystyrene rim support, incl. adhesive, incl. sealing tape, incl. 2 polystyrene blocks for floor support, adjustable height 105 to 150 mm	
U91411300	Installation set, for large sizes (1200 x 700 - 1800 x 900), incl. height-adjustable polystyrene rim support, incl. adhesive, incl. sealing tape, incl. 3 polystyrene blocks for floor support, adjustable height 105 to 150 mm	
U82400001	Sealing tape	
U91412100	ViFrame installation frame, for smaller shower trays made of ceramic or acrylic (up to 1000 x 1000 mm), incl. 2 central feet	
U91412200	ViFrame installation frame, for larger shower trays made of ceramic or acrylic (from 1000 x 1000 mm), incl. 4 central feet	

XX = Colour code to be indicated

For further information on colours, please see the page at the beginning of this section.

SHOWER TRAYS

SUBWAY (Square) Acrylic

€ excl. VAT

Not included in scope of delivery:

All shower trays are supplied without support/base.

Technical information:

The installation height of the shower tray can be reduced by 30 mm if the Viega outlet fitting art. no. 634 100 is used. Please note: this outlet fitting does not conform to EN 274.
 Drainage Ø: 90 mm

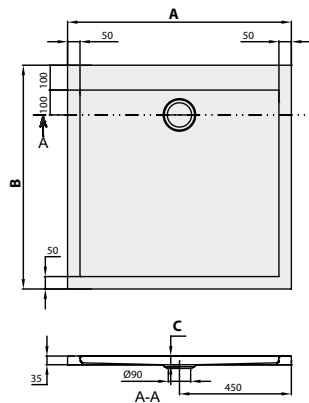

Article number	Name and version	Size l (A) x w	Depth (C)	kg/pc.	01	pcs/pal.
UDA 1035 SUB 1V-XX	Subway	1000 x 1000	35	12,75		25
UDA 0935 SUB 1V-XX		900 x 900		10,5		25

Accessories for shower trays

Article number	Description	Price
U90880261	Tempoplex Plus outlet, plastic, ø 90 mm, Drainage capacity: 51 l/min, chrome	
U90880368	Tempoplex Plus outlet, plastic, ø 90 mm, Drainage capacity: 51 l/min, White	
U82990000	Shower tray feet, steel, adjustable height 105 to 190 mm	
U91412100	ViFrame installation frame, for smaller shower trays made of ceramic or acrylic (up to 1000 x 1000 mm), incl. 2 central feet	
U91412200	ViFrame installation frame, for larger shower trays made of ceramic or acrylic (from 1000 x 1000 mm), incl. 4 central feet	

SUBWAY (Rectangle) Acrylic

€ excl. VAT

Not included in scope of delivery:
Technical information:

All shower trays are supplied without support/base.

From size 1400 x 900 two supports (U82990000) are required.

The installation height of the shower tray can be reduced by 30 mm if the Viega outlet fitting art. no. 634 100 is used. Please note: this outlet fitting does not conform to EN 274.

Drainage Ø: 90 mm

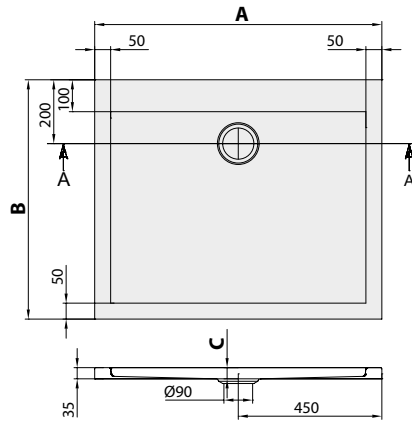

Article number	Name and version	Size l (A) x w	Depth (C)	kg/pc.	01	pcs/pal.
UDA 1893 SUB 2V-XX	Subway	1800 x 900	35	33		10
UDA 1693 SUB 2V-XX		1600 x 900		28		9
UDA 1493 SUB 2V-XX		1400 x 900		23		20
UDA 1293 SUB 2V-XX		1200 x 900		15		20
UDA 1835 SUB 2V-XX		1000 x 800		11,5		25

Accessories for shower trays

Article number	Description	Price
U90880261	Tempoplex Plus outlet, plastic, ø 90 mm, Drainage capacity: 51 l/min, chrome	
U90880368	Tempoplex Plus outlet, plastic, ø 90 mm, Drainage capacity: 51 l/min, White	
U82990000	Shower tray feet, steel, adjustable height 105 to 190 mm	
U91412100	ViFrame installation frame, for smaller shower trays made of ceramic or acrylic (up to 1000 x 1000 mm), incl. 2 central feet	
U91412200	ViFrame installation frame, for larger shower trays made of ceramic or acrylic (from 1000 x 1000 mm), incl. 4 central feet	

ACCESSORIES FOR SHOWER TRAYS

€ excl. VAT

ViFrame

Installation frame for all shower trays in Quaryl, acrylic and ceramic

The ViFrame installation frame serves to fix and support Quaryl, acrylic and ceramic shower trays. We offer these in 4 versions: two variants for smaller and large shower tray sizes and two variants with or without central foot. The central feet provide additional support in the centre of ceramic and acrylic shower trays. The 2-stage height adjustment range (from 90 - 175 mm) can be easily adjusted from above using an Allen key.

Note:

- We recommend the use of silicon or a similar flexible adhesive between installation frame and shower tray
- Correct installation also includes fixing the feet to the floor with the fastening set supplied

Advantage:

- The height of the new installation frame is easy to adjust from above.

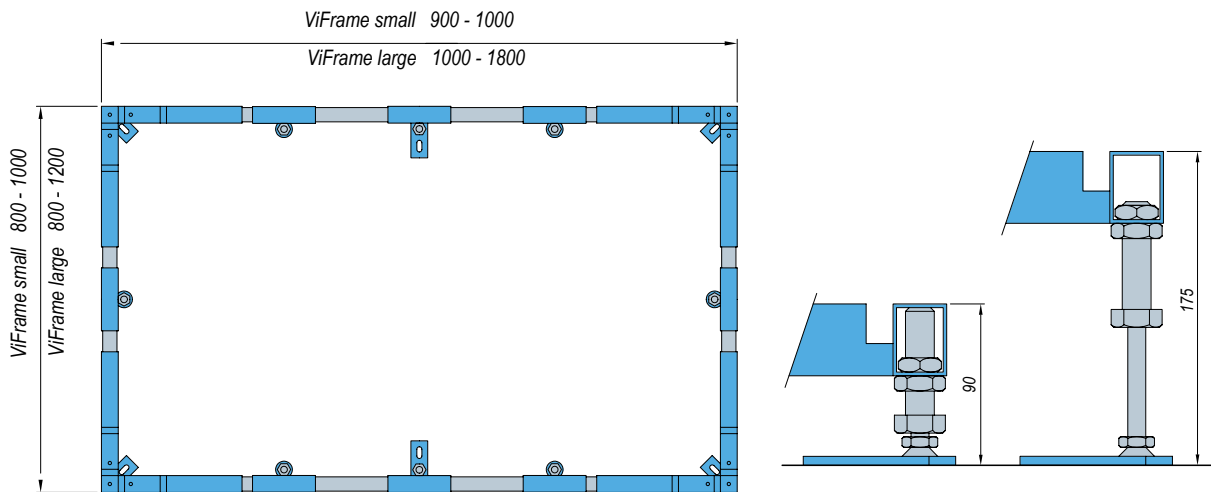

Article number	Description	Price
U91412100	ViFrame installation frame, for smaller shower trays made of ceramic or acrylic (up to 1000 x 1000 mm), incl. 2 central feet	
U91412200	ViFrame installation frame, for larger shower trays made of ceramic or acrylic (from 1000 x 1000 mm), incl. 4 central feet	
U91412300	ViFrame installation frame, for smaller shower trays made of Quaryl (up to 1000 x 1000 mm), without central foot	
U91412400	ViFrame installation frame, for larger shower trays made of Quaryl (from 1000 x 1000 mm), without central foot	

ACCESSORIES

BATHS & WHIRLPOOL SYSTEMS



GLOSSY COLOURS

MATT COLOURS

01 White Alpine

RW Stone White



PANEL COLOURS BATHS

01 White Alpine

RW Stone White



AVEO ¹⁾
LA BELLE
LOOP & FRIENDS ²⁾³⁾
SQUARO ²⁾
SUBWAY ²⁾³⁾

AVEO ¹⁾
LA BELLE
LOOP & FRIENDS ²⁾
SQUARO ²⁾
SUBWAY ²⁾

1) Bath free-standing
2) Bath Corner

SURFACE OF VISIBLE PARTS OF WHIRLPOOL SYSTEMS

61 Chrome-plated



62 Gold plated



01 White Alpine



RW Stone White



SPECIAL COMBIPOOL INVISIBLE (IP)

UNITED BATH PANELLING

FQ Oak Graphite



DH Glossy White



MULTIFUNCTION CUSHION

LK Bali



LL Peru



PA Anthracite



COLOUR FOR FEET

Beech



HOMMAGE

White



HOMMAGE

COLOUR ON DEMAND (FOR SELECTED, FREE-STANDING BATHS)

BCW0 Fog



BCW2 Ocean



BCW8 Rust



BCW9 Indian Summer



BCT0 Powder



BCT7 French Linen



BCT8 Coal Black



BCS8 Sage Green



BCS9 Bordeaux



INDEX - BATH AND WHIRLPOOL SYSTEMS

GENERAL INFORMATION

How to use this price list	2
Wellness colour survey	8

OVERVIEWS

Baths according to shape and dimension	378-382
--	---------

BATHS

Antheus	<i>Premium</i>	383-386
Architectura	<i>Profi</i>	387-395
Aveo	<i>Premium</i>	396
Aveo New Generation	<i>Premium</i>	397-398
Cetus	<i>Premium</i>	399-400
Collaro	<i>Mainstream</i>	401-412
Finion	<i>Premium</i>	413-420
Hommage	<i>Premium</i>	421
La Belle / La Belle Excellence	<i>Premium</i>	422-426
Legato	<i>Mainstream</i>	427-430
Libra	<i>Mainstream</i>	431-433
Loop & Friends	<i>Mainstream</i>	434-455
My Art	<i>Mainstream</i>	456-457
Nexus	<i>Premium</i>	458
Oberon	<i>Mainstream</i>	459-463
Oberon 2.0	<i>Premium</i>	464-468
Pavia	<i>Mainstream</i>	469
Squaro / Squaro Slim Line	<i>Mainstream</i>	470-473
Squaro Edge 12 / Squaro Excellence	<i>Mainstream</i>	474-482
Subway	<i>Mainstream</i>	483
Subway 3.0	<i>Mainstream</i>	491
Theano	<i>Premium</i>	496

ACCESSORIES FOR BATHS

Colour on Demand		500
TouchLight	<i>Mainstream</i>	503
UNITED / Profibox 2.0	<i>Premium / Profi</i>	504
Multifunction cushion / Handgrips	<i>Mainstream</i>	505
ViFlow	<i>Premium</i>	506-507

WHIRLPOOL SYSTEMS

Overview of whirlpool equipment		508
Airpool Entry (AE)	<i>Profi</i>	509
Airpool Comfort (AC)	<i>Mainstream</i>	509
Hydropool Entry (HE)	<i>Profi</i>	510
Hydropool Comfort (HC)	<i>Mainstream</i>	510
Combipool Entry (CE)	<i>Profi</i>	511
Combipool Comfort (CC)	<i>Mainstream</i>	512
Combipool Invisible (IP)	<i>Premium</i>	513
Combipool Active (AP)	<i>Premium</i>	514
Visible parts		515
Whirlpool systems - Explanation Equipment		516-517

ORDER FORM

Pre-drilled holes order form		518
Order form whirlpool systems		see fold-out page on the right
Preassembled options		

BATHS ACCORDING TO SHAPE AND DIMENSION

OVERVIEW

Corner, Length 1300 mm Width: 1300 mm	Corner, Length 1400 mm Width: 1400 mm	Corner, Length 1400 mm Width: 1400 mm	Corner, Length 1450 mm Width: 1450 mm	Free-standing, Length 1550 mm Width: 750 mm	Free-standing, Length 1550 mm Width: 750 mm	Free-standing, Length 1550 mm Width: 750 mm
Subway ● UBA130SUB3V (564)	Loop & Friends ● UBA140LFS3V (516)	Loop & Friends ● UBA140LFO3V (527)	Squaro ● UBQ1455QR3V (549)	Antheus ● UBQ155ANH7F400V (455)	Antheus ● UBQ155ANH7F4BCV (456)	Theano ● UBQ155ANH7F2BCV (574)

Free-standing, Length 1550 mm Width: 750 mm	Free-standing, Length 1700 mm Width: 700 mm	Free-standing, Length 1700 mm Width: 700 mm	Free-standing, Length 1700 mm Width: 700 mm	Free-standing, Length 1700 mm Width: 700 mm	Free-standing, Length 1700 mm Width: 700 mm	Free-standing, Length 1700 mm Width: 700 mm
Theano ● UBQ155ANH7F200V (573)	Finion ● UBQ177FIN7A300V4 (489)	Finion ● UBQ177FIN7A3BCV4 (492)	Finion ● UBQ177FIN7A2BCV4 (491)	Finion ● UBQ177FIN7A1BCV4 (490)	Finion ● UBQ177FIN7A200V4 (488)	Finion ● UBQ177FIN7A100V4 (487)

Free-standing, Length 1750 mm Width: 800 mm	Free-standing, Length 1750 mm Width: 800 mm	Free-standing, Length 1750 mm Width: 800 mm	Free-standing, Length 1750 mm Width: 800 mm	Free-standing, Length 1771 mm Width: 771 mm	Free-standing, Length 1800 mm Width: 800 mm	Free-standing, Length 1800 mm Width: 800 mm
Antheus ● UBQ175ANH7F400V (457)	Antheus ● UBQ175ANH7F4BCV (458)	Theano ● UBQ175ANH7F200V (575)	Theano ● UBQ175ANH7F2BCV (576)	Hommage ● UBQ180HOM700V (493)	La Belle ● UBQ180LAB9W1V (497)	La Belle ● UBQ180LAB2PDBCVCV (496)

Free-standing, Length 1800 mm Width: 800 mm	Free-standing, Length 1800 mm Width: 800 mm	Free-standing, Length 1800 mm Width: 800 mm	Free-standing, Length 1800 mm Width: 800 mm	Free-standing, Length 1800 mm Width: 800 mm	Free-standing, Length 1800 mm Width: 800 mm	Free-standing, Length 1800 mm Width: 800 mm
La Belle ● UBQ180LAB2PDV (495)	La Belle ● UBQ180LAB9T1BCV (498)	Loop & Friends ● UBA180LFS7PDV (512)	Loop & Friends ● UBA180LFO7PDBCVCV (524)	Loop & Friends ● UBA180LFS7PDBCVCV (513)	Loop & Friends ● UBA180LFO7PDV (523)	Squaro Edge 12 ● UBQ180SQE9W2V (558)

Material
● QUARYL® ● ACRYLIC

BATHS ACCORDING TO SHAPE AND DIMENSION

OVERVIEW

Free-standing, Length 1800 mm

Width: 800 mm

Width: 800 mm

Width: 800 mm



Squaro Edge 12 ●

Squaro Edge 12 ●

Squaro Edge 12 ●

UBQ180SQE7PDBCVCV (557)

UBQ180SQE7PDV (556)

UBQ180SQE9T2BCV (559)

Free-standing, Length 1900 mm

Width: 950 mm

Width: 950 mm

Width: 950 mm



Aveo ●

Aveo New Generation ●

Aveo New Generation ●

UBQ194AVE9PDV (468)

UBQ194AVE9W1V (469)

UBQ194AVE9W1BCV (470)

Hexagonal, Length 1900 mm

Width: 800 mm



Squaro ●

UBQ190SQR6V (550)

Hexagonal, Length 1900 mm

Width: 800 mm

Width: 900 mm

Width: 900 mm



Subway ●

Loop & Friends ●

Loop & Friends ●

UBA190SUB6V (567)

UBA199LFO6V (521)

UBA199LFS6V (510)

Offset, Length 1700 mm

Width: 800 mm

Width: 800 mm



Subway ●

Subway ●

UBA178SUB3LIV (565)

UBA178SUB3REV (566)

Oval, Length 1750 mm

Width: 750 mm



Cetus ●

UBQ175CEU7V (472)

Oval, Length 1771 mm

Width: 771 mm



Nexus ●

UBQ180NEU7V (530)

Oval, Length 1800 mm

Width: 800 mm

Width: 800 mm

Width: 800 mm



Loop & Friends ●

Loop & Friends ●

Squaro Edge 12 ●

UBA180LFO7V (522)

UBA180LFS7V (511)

UBQ180SQE7DV (555)

Oval, Length 1900 mm

Width: 950 mm



Aveo ●

UBQ194AVE7V (467)

Rectangle, Length 1400 mm

Width: 700 mm



Architectura ●

UBA147ARA2V (459)

Rectangle, Length 1500 mm

Width: 700 mm



Architectura ●

UBA157ARA2V (460)

Rectangle, Length 1600 mm

Width: 700 mm



Architectura ●

UBA167ARA2V (461)

Rectangle, Length 1600 mm

Width: 700 mm

Width: 700 mm

Width: 750 mm

Width: 750 mm

Width: 750 mm



Libra ●

Subway ●

Collaro ●

Oberon ●

UBQ167LIB2V (503)

UBA167SUB2V (560)

UBA160COR2DV (475)

UBQ160OBE2V (531)

Rectangle, Length 1700 mm

Width: 700 mm



Architectura ●

UBA177ARA2V (462)

Material

● QUARYL®

● ACRYLIC

BATHS ACCORDING TO SHAPE AND DIMENSION

OVERVIEW

Rectangle, Length 1700 mm

Width: 700 mm



Legato ●
UBA177LEG2V (499)

Width: 700 mm



Loop & Friends ●
UBA177LFO2V (517)

Width: 700 mm



Loop & Friends ●
UBA177LFS2V (506)

Width: 700 mm



Oberon ●
UBQ1770BE2V (532)

Width: 750 mm



Architectura ●
UBA170ARA2V (463)

Width: 750 mm



Collaro ●
UBA170COR2DV (476)

Rectangle, Length 1700 mm

Width: 750 mm



Legato ●
UBA170LEG2V (500)

Width: 750 mm



Libra ●
UBQ170LIB2V (504)

Width: 750 mm



Loop & Friends ●
UBA170LFO2V (518)

Width: 750 mm



Loop & Friends ●
UBA170LFS2V (507)

Width: 750 mm



My Art ●
UBQ170MYA2V (528)

Width: 750 mm



Oberon ●
UBQ1700BE2V (533)

Rectangle, Length 1700 mm

Width: 750 mm



Oberon 2.0 ●
UBQ1700BR2DV (536)

Width: 750 mm



Pavia ●
UBQ170PAV2V (546)

Width: 750 mm



Squaro ●
UBQ170SQR2V (547)

Width: 750 mm



Squaro Edge 12 ●
UBQ170SQE2DV (552)

Width: 750 mm



Subway ●
UBA170SUB2V (561)

Width: 750 mm



Subway 3.0 ●
UBQ170SBW2DV (569)

Width: 750 mm



Subway 3.0 ●
UBQ170SBW2TDV (570)

Rectangle, Length 1700 mm

Width: 800 mm



Architectura ●
UBA178ARA2V (464)

Rectangle, Length 1800 mm

Width: 800 mm



Architectura ●
UBA180ARA2V (465)

Width: 800 mm



Cetus ●
UBQ180CEU2V (471)

Width: 800 mm



Collaro ●
UBA180COR2DV (477)

Width: 800 mm



La Belle ●
UBQ180LAB2V (494)

Width: 800 mm



Legato ●
UBA180LEG2V (501)

Width: 800 mm



Libra ●
UBQ180LIB2V (505)

Material

● QUARYL®

● ACRYLIC

BATHS ACCORDING TO SHAPE AND DIMENSION

OVERVIEW

Rectangle, Length 1800 mm

Width: 800 mm



Loop & Friends ●
UBA180LFS2V (508)

Width: 800 mm



Loop & Friends ●
UBA180LFO2V (519)

Width: 800 mm



My Art ●
UBQ180MYA2V (529)

Width: 800 mm



Oberon ●
UBQ180OBE2V (534)

Width: 800 mm



Oberon 2.0 ●
UBQ181OBR2DV (538)

Width: 800 mm



Oberon 2.0 ●
UBQ180OBR2DV (537)

Rectangle, Length 1800 mm

Width: 800 mm



Squaro ●
UBQ180SQR2V (548)

Width: 800 mm



Squaro Edge 12 ●
UBQ180SQE2DV (553)

Width: 800 mm



Subway ●
UBA180SUB2V (562)

Width: 800 mm



Subway 3.0 ●
UBQ180SBW2TDV (572)

Width: 800 mm



Subway 3.0 ●
UBQ180SBW2DV (571)

Rectangle, Length 1900 mm

Width: 900 mm



Architettura ●
UBA199ARA2V (466)

Width: 900 mm



Collaro ●
UBA199COR2DV (478)

Rectangle, Length 1900 mm

Width: 900 mm



Legato ●
UBA199LEG2V (502)

Width: 900 mm



Loop & Friends ●
UBA199LFO2V (520)

Width: 900 mm



Loop & Friends ●
UBA199LFS2V (509)

Width: 900 mm



Oberon ●
UBQ199OBE2V (535)

Width: 900 mm



Squaro Edge 12 ●
UBQ190SQE2DV (554)

Width: 900 mm



Subway ●
UBA199SUB2V (563)

Special shape, Length 1750 mm

Width: 1350 mm



Loop & Friends ●
UBA175LFO9REV (526)

Width: 1350 mm



Loop & Friends ●
UBA175LFO9LIV (525)

Width: 1350 mm



Loop & Friends ●
UBA175LFS9LIV (514)

Width: 1350 mm



Loop & Friends ●
UBA175LFS9REV (515)

Wall-facing, Length 1800 mm

Width: 800 mm



Collaro ●
UBA180COR9CS00VD (483)

Width: 800 mm



Collaro ●
UBA180COR9CSBCVD (484)

Width: 800 mm



Oberon 2.0 ●
UBQ180OBR9CD00V (539)

Material

● QUARYL®

● ACRYLIC

BATHS ACCORDING TO SHAPE AND DIMENSION

OVERVIEW

Wall-facing, Length 1800 mm

Width: 800 mm



Oberon 2.0 ●

UBQ180BR9CDBCVCV (540)

Wall-facing, left-hand model, Length 1800 mm

Width: 800 mm



Collaro ●

UBA180COR9CL00VD (479)

Width: 800 mm



Collaro ●

UBA180COR9CLBCVD (480)

Wall-facing, right-hand model, Length 1800 mm

Width: 800 mm



Collaro ●

UBA180COR9CR00VD (481)

Width: 800 mm



Collaro ●

UBA180COR9CRBCVD (482)

Material

● QUARYL®

● ACRYLIC

ANTHEUS Solo (Free-standing 1550 x 750) Quarryl®

€ excl. VAT

Included in scope of delivery:

The stainless steel frame is supplied (pre-installed, high gloss polished).

Not included in scope of delivery:

Push-to-Open valve without overflow function and ViFlow.

Technical information:

Please note: In accordance with DIN 1986-100, a floor drain is required to protect the building against flooding, if a bath is installed without an overflow. No floor drain is required if ViFlow is used.

Matching sanitary ceramics:

Antheus

Matching furniture programme:

Antheus

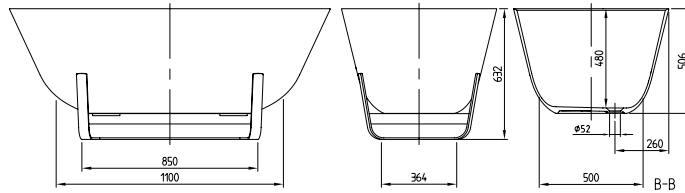
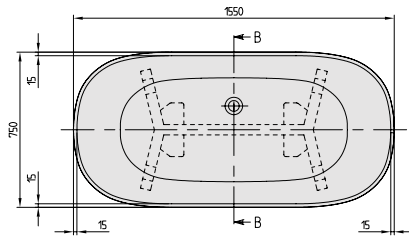

BATHS

Article number	Description	Size l x w	Bottom l x w	Depth	Litres incl. 1 pers	Weight (kg)	01	RW	pcs/pal.
UBQ 155 ANH 7F400V-XX	Antheus, freestanding	1550 x 750	1100 x 500	480	250	68,4			1

Accessories for baths:

Article number	Description	Price
U906100XX	Multifunction cushion, foam, 240 x 150 x 50 mm	
U90952061	Push-to-Open valve without overflow function (Outlet cover White & Chrome), chrome	
U909520RW	Push-to-Open valve without overflow function (Outlet cover White & Chrome), Stone White (NEW)	
U90952033	Push-to-Open valve without overflow function (Outlet cover White & Chrome), Black Matt (NEW)	
U90953061	ViFlow, Outlet and overflow fittings without an overflow, chrome	
U90953068	ViFlow, Outlet and overflow fittings without an overflow, White	
U909530RW	ViFlow, Outlet and overflow fittings without an overflow, Stone White (NEW)	
U90953033	ViFlow, Outlet and overflow fittings without an overflow, Black Matt (NEW)	

XX = Colour code to be indicated

For further information on colours, please see the page at the beginning of this section.

Further information on whirlpool systems please see page 585.

ANTHEUS Solo (Free-standing 1550 x 750) Quarryl®, Colour on Demand

€ excl. VAT

Included in scope of delivery:

The stainless steel frame is supplied (pre-installed, high gloss polished).

Not included in scope of delivery:

Push-to-Open valve without overflow function and ViFlow.

Technical information:

Please note: In accordance with DIN 1986-100, a floor drain is required to protect the building against flooding, if a bath is installed without an overflow. No floor drain is required if ViFlow is used.

Matching sanitary ceramics:

Antheus

Matching furniture programme:

Antheus

BATHS

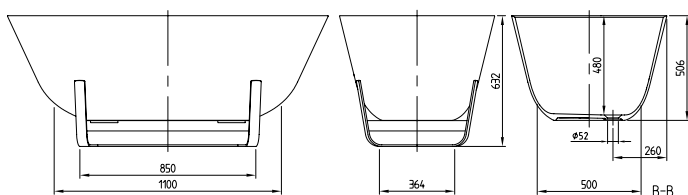
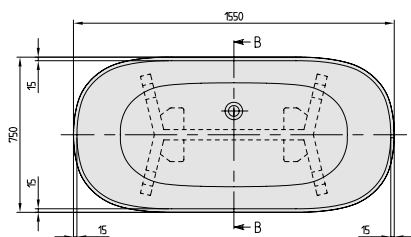

Quarryl®

Article number	Description	Size l x w	Bottom l x w	Depth	Litres incl. 1 pers	Weight (kg)	01	RW	pcs/pal.
UBQ 155 ANH 7F4BCV-XX	Antheus, freestanding, Colour on Demand (Quarryl®)	1550 x 750	1100 x 500	480	250	68,4			1

Accessories for baths:

Article number	Description	Price
U906100XX	Multifunction cushion, foam, 240 x 150 x 50 mm	
U90952061	Push-to-Open valve without overflow function (Outlet cover White & Chrome), chrome	
U909520RW	Push-to-Open valve without overflow function (Outlet cover White & Chrome), Stone White (NEW)	
U90952033	Push-to-Open valve without overflow function (Outlet cover White & Chrome), Black Matt (NEW)	
U90953061	ViFlow, Outlet and overflow fittings without an overflow, chrome	
U90953068	ViFlow, Outlet and overflow fittings without an overflow, White	
U909530RW	ViFlow, Outlet and overflow fittings without an overflow, Stone White (NEW)	
U90953033	ViFlow, Outlet and overflow fittings without an overflow, Black Matt (NEW)	

Made-to-order production - Colour on Demand: 3 week delivery period. Please make sure to use the **order form** that you will find immediately after the chapter on baths on page 578-579, so that we can complete the order for you.

XX = Colour code to be indicated

For further information on colours, please see the page at the beginning of this section.

Further information on whirlpool systems please see page 585.

ANTHEUS Duo (Free-standing 1750 x 800) Quarryl®

€ excl. VAT

Included in scope of delivery:

The stainless steel frame is supplied (pre-installed, high gloss polished).

Not included in scope of delivery:

Push-to-Open valve without overflow function and ViFlow.

Technical information:

Please note: In accordance with DIN 1986-100, a floor drain is required to protect the building against flooding, if a bath is installed without an overflow. No floor drain is required if ViFlow is used.

Matching sanitary ceramics:

Antheus

Matching furniture programme:

Antheus

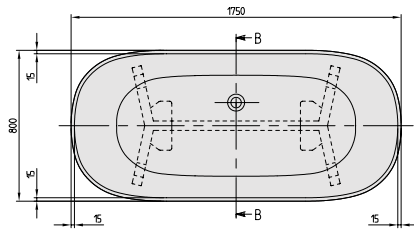

Quarryl®

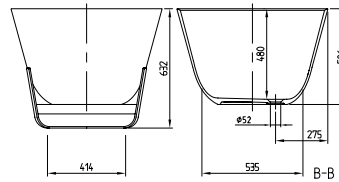
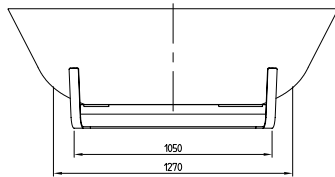

Article number	Description	Size l x w	Bottom l x w	Depth	Litres incl. 1 pers	Weight (kg)	01	RW	pcs/pal.
UBQ 175 ANH 7F400V-XX	Antheus, freestanding	1750 x 800	1270 x 535	480	315	75,9			1

Accessories for baths:

Article number	Description	Price
U906100XX	Multifunction cushion, foam, 240 x 150 x 50 mm	
U90952061	Push-to-Open valve without overflow function (Outlet cover White & Chrome), chrome	
U909520RW	Push-to-Open valve without overflow function (Outlet cover White & Chrome), Stone White (NEW)	
U90952033	Push-to-Open valve without overflow function (Outlet cover White & Chrome), Black Matt (NEW)	
U90953061	ViFlow, Outlet and overflow fittings without an overflow, chrome	
U90953068	ViFlow, Outlet and overflow fittings without an overflow, White	
U909530RW	ViFlow, Outlet and overflow fittings without an overflow, Stone White (NEW)	
U90953033	ViFlow, Outlet and overflow fittings without an overflow, Black Matt (NEW)	

XX = Colour code to be indicated

For further information on colours, please see the page at the beginning of this section.

Further information on whirlpool systems please see page 585.

ANTHEUS Duo (Free-standing 1750 x 800) Quarryl®, Colour on Demand

€ excl. VAT

Included in scope of delivery:

The stainless steel frame is supplied (pre-installed, high gloss polished).

Not included in scope of delivery:

Push-to-Open valve without overflow function and ViFlow.

Technical information:

Please note: In accordance with DIN 1986-100, a floor drain is required to protect the building against flooding, if a bath is installed without an overflow. No floor drain is required if ViFlow is used.

Matching sanitary ceramics:

Antheus

Matching furniture programme:

Antheus

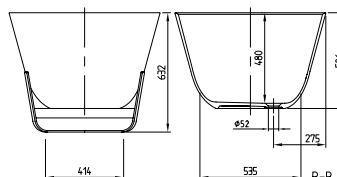
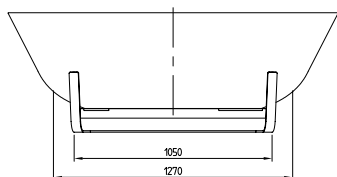
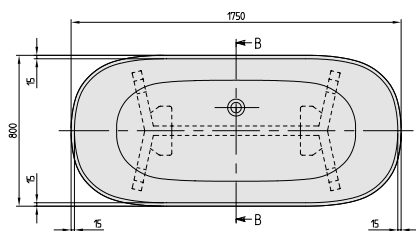

Quarryl®

Article number	Description	Size l x w	Bottom l x w	Depth	Litres incl. 1 pers	Weight (kg)	01	RW	pcs/pal.
UBQ 175 ANH 7F4BCV-XX	Antheus, freestanding, Colour on Demand (Quarryl®)	1750 x 800	1270 x 535	480	315	75,9			1

Accessories for baths:

Article number	Description	Price
U906100XX	Multifunction cushion, foam, 240 x 150 x 50 mm	
U90952061	Push-to-Open valve without overflow function (Outlet cover White & Chrome), chrome	
U909520RW	Push-to-Open valve without overflow function (Outlet cover White & Chrome), Stone White (NEW)	
U90952033	Push-to-Open valve without overflow function (Outlet cover White & Chrome), Black Matt (NEW)	
U90953061	ViFlow, Outlet and overflow fittings without an overflow, chrome	
U90953068	ViFlow, Outlet and overflow fittings without an overflow, White	
U909530RW	ViFlow, Outlet and overflow fittings without an overflow, Stone White (NEW)	
U90953033	ViFlow, Outlet and overflow fittings without an overflow, Black Matt (NEW)	

Made-to-order production - Colour on Demand: 3 week delivery period. Please make sure to use the **order form** that you will find immediately after the chapter on baths on page 578-579, so that we can complete the order for you.

XX = Colour code to be indicated

For further information on colours, please see the page at the beginning of this section.
Further information on whirlpool systems please see page 585.

ARCHITECTURA Solo (Rectangle 1400 x 700) Acrylic

€ excl. VAT

Not included in scope of delivery: Set of bath feet is not supplied as standard.
Matching sanitary ceramics: Architectura

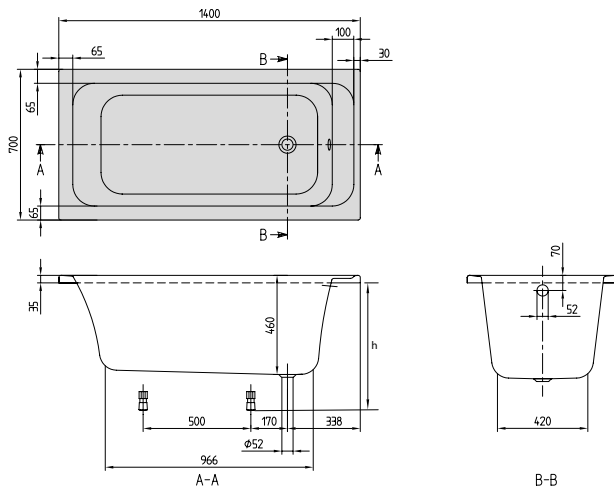

h = Installation height (min - max)	
Bath	565 - 615

Article number	Description	Size l x w	Bottom l x w	Depth	Litres incl. 1 pers	Weight (kg)	01	pcs/pal.
UBA 147 ARA 2V-XX	Architectura	1400 x 700	970 x 420	460	110	17		10

Accessories for baths:

Article number	Description	Price
U99740000	Bath feet, plastic, for baths with even bottom, adjustable from 130 à 180 mm	
U90950461	Multiplex waste/overflow combination, chrome	
UCCON0475	Pipe interruptor, incl. connections	
U90600361	Multiplex Trio Outlet/overflow fitting with water inlet, chrome	
U90600461	Multiplex Trio Outlet/overflow fitting with water inlet and pipe interruptor, chrome	
U90170061	Handgrips, 1 pair = 2 grips, chrome	
U906100XX	Multifunction cushion, foam, 240 x 150 x 50 mm	

Preassembled bath options in combination with:

For order form, see fold-out page on the right-hand side

TouchLight	Price

XX = Colour code to be indicated
 For further information on colours, please see the page at the beginning of this section.
 Further information on whirlpool systems please see page 585.

BATHS

ARCHITECTURA Solo (Rectangle 1500 x 700) Acrylic

€ excl. VAT

Not included in scope of delivery: Set of bath feet is not supplied as standard.
Technical information: Whirlpool systems available on request.
Matching sanitary ceramics: Architectura

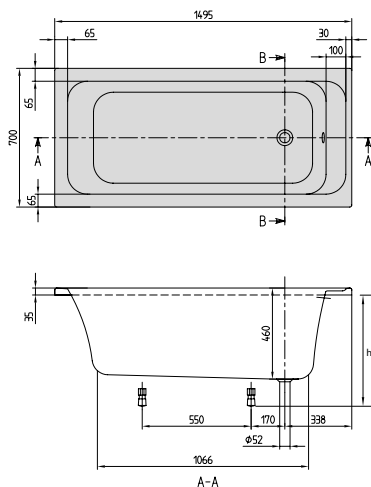

h = Installation height (min - max)	
Bath	565 - 615

Article number	Description	Size l x w	Bottom l x w	Depth	Litres incl. 1 pers	Weight (kg)	01	pcs/pal.
UBA 157 ARA 2V-XX	Architectura	1500 x 700	1070 x 420	460	125	19		10

Accessories for baths:

Article number	Description	Price
U99740000	Bath feet, plastic, for baths with even bottom, adjustable from 130 à 180 mm	
U90950461	Multiplex waste/overflow combination, chrome	
UCCON0475	Pipe interruptor, incl. connections	
U90600361	Multiplex Trio Outlet/overflow fitting with water inlet, chrome	
U90600461	Multiplex Trio Outlet/overflow fitting with water inlet and pipe interrupter, chrome	
U90170061	Handgrips, 1 pair = 2 grips, chrome	
U906100XX	Multifunction cushion, foam, 240 x 150 x 50 mm	

Preassembled bath options in combination with:

For order form, see fold-out page on the right-hand side

TouchLight	Price

XX = Colour code to be indicated
 For further information on colours, please see the page at the beginning of this section.
 Further information on whirlpool systems please see page 585.

ARCHITECTURA Solo (Rectangle 1600 x 700) Acrylic

€ excl. VAT

Not included in scope of delivery: Set of bath feet is not supplied as standard.
Matching sanitary ceramics: Architectura

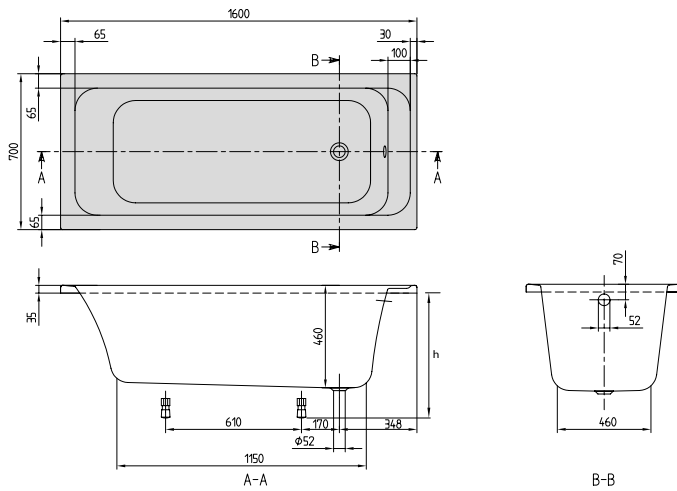

h = Installation height (min - max)	
Bath	565 - 615
Whirlpool system	605 - 645
Profibox 2.0 without system	585 - 585
Profibox 2.0 incl. System	625 - 625

Article number	Description	Size l x w	Bottom l x w	Depth	Litres incl. 1 pers	Weight (kg)	01	pcs/pal.
UBA 167 ARA 2V-XX	Architectura	1600 x 700	1150 x 460	460	165	21		10

Accessories for baths:

Article number	Description	Price
U99740000	Bath feet, plastic, for baths with even bottom, adjustable from 130 à 180 mm	
U90950461	Multiplex waste/overflow combination, chrome	
UCCON0475	Pipe interruptor, incl. connections	
U90600361	Multiplex Trio Outlet/overflow fitting with water inlet, chrome	
U90600461	Multiplex Trio Outlet/overflow fitting with water inlet and pipe interruptor, chrome	
U90170061	Handgrips, 1 pair = 2 grips, chrome	
U906100XX	Multifunction cushion, foam, 240 x 150 x 50 mm	

Preassembled bath options in combination with:			Airpools		Hydropools		Combipools		Special Combipools	
For order form, see fold-out page on the right-hand side			AE	AC	HE	HC	CE	CC	IP	AP
Profibox 2.0 alcove		○	○	○	-	-	-	-	-	-
Profibox 2.0 corner		○	○	○	-	-	-	-	-	-
TouchLight		○	-	-	-	-	-	-	-	-

Whirlpool Systems		Airpools		Hydropools		Combipools		Special Combipools	
Article number	Description	AE	AC	HE	HC	CE	CC	IP	AP
U__ 167 ARA 2A ½ V XX	Price of whirlpool system incl. bath								
U__ 167 ARA 2B ½ V XX	Price of whirlpool system incl. bath incl. Multiplex Trio								

For the following whirlpool systems the technology protrudes:

Technical parts	Side 1-2	Side 1-3	Side 2-4	Side 1-2	Side 1-3	Side 2-4	Side 1-2	Side 1-3	Side 2-4	Side 1-2	Side 1-3	Side 2-4
Technical parts 1	-	-	-	+5	+5	+5	+5	+5	-	+60	+20	+20
Technical parts 2	-	-	-	+5	+5	+5	+5	-	-	+60	+20	+20

Please replace __ in article number with whirlpool code.

Please replace ½ in article number with desired position of technical equipment (1 = Layout 1, 2 = Layout 2). The back jets are located at the end at which the technical equipment is installed.

For further options use the order form (see right-hand fold-out page)

Technical parts 1

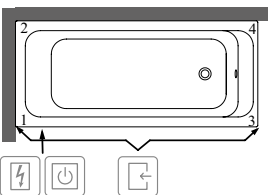

Technical parts 2

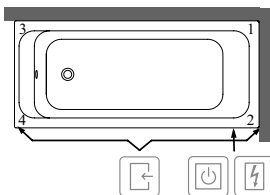

- Accessible via
- Control box
- Rim control

This symbol "O" means this option is possible

XX = Colour code to be indicated

For further information on colours, please see the page at the beginning of this section.

Further information on whirlpool systems please see page 585.

BATHS

ARCHITECTURA Solo (Rectangle 1700 x 700) Acrylic

€ excl. VAT

Not included in scope of delivery: Set of bath feet is not supplied as standard.
Matching sanitary ceramics: Architectura

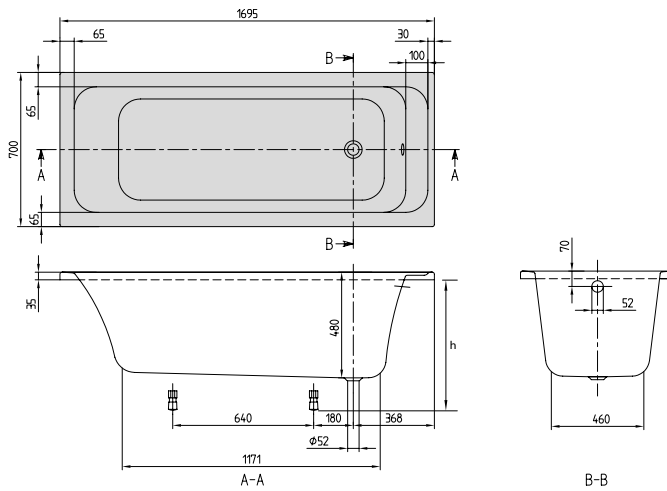

h = Installation height (min - max)	
Bath	585 - 635
Whirlpool system	625 - 665
Profibox 2.0 without system	585 - 585
Profibox 2.0 incl. System	625 - 625

Article number	Description	Size l x w	Bottom l x w	Depth	Litres incl. 1 pers	Weight (kg)	01	pcs/pal.
UBA 177 ARA 2V-XX	Architectura	1700 x 700	1200 x 460	480	195	23		10

Accessories for baths:

Article number	Description	Price
U99740000	Bath feet, plastic, for baths with even bottom, adjustable from 130 à 180 mm	
U90950461	Multiplex waste/overflow combination, chrome	
UCCON0475	Pipe interruptor, incl. connections	
U90600361	Multiplex Trio Outlet/overflow fitting with water inlet, chrome	
U90600461	Multiplex Trio Outlet/overflow fitting with water inlet and pipe interruptor, chrome	
U90170061	Handgrips, 1 pair = 2 grips, chrome	
U906100XX	Multifunction cushion, foam, 240 x 150 x 50 mm	

Preassembled bath options in combination with: For order form, see fold-out page on the right-hand side	only bath	Airpools		Hydropools		Combipools		Special Combipools	
		AE	AC	HE	HC	CE	CC	IP	AP
Profibox 2.0 alcove	<input type="radio"/>	<input type="radio"/>	<input type="radio"/>	<input type="radio"/>	<input type="radio"/>	<input type="radio"/>	<input type="radio"/>	<input type="radio"/>	-
Profibox 2.0 corner	<input type="radio"/>	<input type="radio"/>	<input type="radio"/>	<input type="radio"/>	<input type="radio"/>	<input type="radio"/>	<input type="radio"/>	<input type="radio"/>	-
TouchLight	<input type="radio"/>	-	-	-	-	-	-	-	-

Whirlpool Systems		Airpools		Hydropools		Combipools		Special Combipools	
Article number	Description	AE	AC	HE	HC	CE	CC	IP	AP
U__ 177 ARA 2A ½ V XX	Price of whirlpool system incl. bath								
U__ 177 ARA 2B ½ V XX	Price of whirlpool system incl. bath incl. Multiplex Trio								

For the following whirlpool systems the technology protrudes:

Technical parts 1	Side 1-2	Side 1-3	Side 2-4	Technical parts 2	Side 1-2	Side 1-3	Side 2-4
	-	-	-		-	-	-
	-	-	-		-	-	-
	-	-	-		-	-	-
	-	-	-		-	-	-
	-	-	-		-	-	-

Please replace __ in article number with whirlpool code.

Please replace ½ in article number with desired position of technical equipment (1 = Layout 1, 2 = Layout 2). The back jets are located at the end at which the technical equipment is installed.

For further options use the order form (see right-hand fold-out page)

Technical parts 1

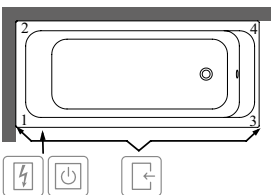

Technical parts 2

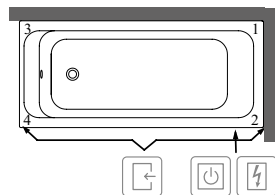

-  Accessible via
-  Control box
-  Rim control

This symbol "O" means this option is possible

XX = Colour code to be indicated

For further information on colours, please see the page at the beginning of this section.

Further information on whirlpool systems please see page 585.

ARCHITECTURA Solo (Rectangle 1700 x 750) Acrylic

€ excl. VAT

Not included in scope of delivery: Set of bath feet is not supplied as standard.
Matching sanitary ceramics: Architectura

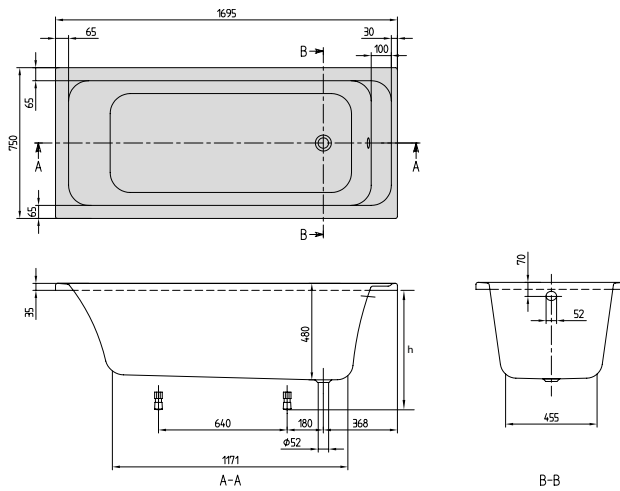

h = Installation height (min - max)	
Bath	585 - 635
Whirlpool system	625 - 665
Profibox 2.0 without system	585 - 585
Profibox 2.0 incl. System	625 - 625

Article number	Description	Size l x w	Bottom l x w	Depth	Litres incl. 1 pers	Weight (kg)	01	pcs/pal.
UBA 170 ARA 2V-XX	Architectura	1700 x 750	1200 x 460	480	210	23		10

Accessories for baths:

Article number	Description	Price
U99740000	Bath feet, plastic, for baths with even bottom, adjustable from 130 à 180 mm	
U90950461	Multiplex waste/overflow combination, chrome	
UCCON0475	Pipe interruptor, incl. connections	
U90600361	Multiplex Trio Outlet/overflow fitting with water inlet, chrome	
U90600461	Multiplex Trio Outlet/overflow fitting with water inlet and pipe interruptor, chrome	
U90170061	Handgrips, 1 pair = 2 grips, chrome	
U906100XX	Multifunction cushion, foam, 240 x 150 x 50 mm	

Preassembled bath options in combination with: For order form, see fold-out page on the right-hand side	only bath	Airpools		Hydropools		Combipools		Special Combipools	
		AE	AC	HE	HC	CE	CC	IP	AP
Profibox 2.0 alcove	<input type="radio"/>	<input type="radio"/>	<input type="radio"/>	<input type="radio"/>	<input type="radio"/>	<input type="radio"/>	<input type="radio"/>	<input type="radio"/>	-
Profibox 2.0 corner	<input type="radio"/>	<input type="radio"/>	<input type="radio"/>	<input type="radio"/>	<input type="radio"/>	<input type="radio"/>	<input type="radio"/>	<input type="radio"/>	-
TouchLight	<input type="radio"/>	-	-	-	-	-	-	-	-

Whirlpool Systems	Article number	Description	Airpools		Hydropools		Combipools		Special Combipools	
			AE	AC	HE	HC	CE	CC	IP	AP
	U__ 170 ARA 2A ½ V XX	Price of whirlpool system incl. bath								
	U__ 170 ARA 2B ½ V XX	Price of whirlpool system incl. bath incl. Multiplex Trio								

For the following whirlpool systems the technology protrudes:

Technical parts 1	Side 1-2	Side 1-3	Side 2-4	Technical parts 2	Side 1-2	Side 1-3	Side 2-4
	-	-	-		-	-	-
	-	-	-		-	-	-
	-	-	-		-	-	-
	-	-	-		-	-	-
	-	-	-		-	-	-

Please replace __ in article number with whirlpool code.

Please replace ½ in article number with desired position of technical equipment (1 = Layout 1, 2 = Layout 2). The back jets are located at the end at which the technical equipment is installed.

For further options use the order form (see right-hand fold-out page)

Technical parts 1

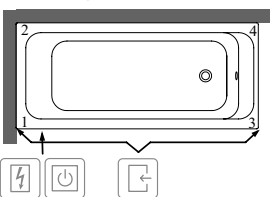

Technical parts 2

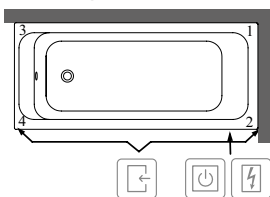

-  Accessible via
-  Control box
-  Rim control

This symbol "O" means this option is possible

XX = Colour code to be indicated

For further information on colours, please see the page at the beginning of this section.

Further information on whirlpool systems please see page 585.

ARCHITECTURA Duo (Rectangle 1700 x 800) Acrylic

€ excl. VAT

Not included in scope of delivery: Set of bath feet is not supplied as standard.
Matching sanitary ceramics: Architectura

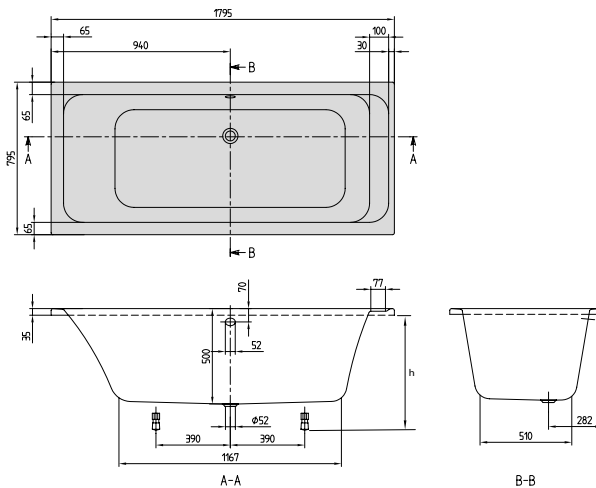

h = Installation height (min - max)	
Bath	585 - 635
Whirlpool system	625 - 665
Profibox 2.0 without system	585 - 585
Profibox 2.0 incl. System	625 - 625

Article number	Description	Size l x w	Bottom l x w	Depth	Litres incl. 1 pers	Weight (kg)	01	pcs/pal.
UBA 178 ARA 2V-XX	Architectura	1700 x 800	1200 x 430	480	215	23		10

Accessories for baths:

Article number	Description	Price
U99740000	Bath feet, plastic, for baths with even bottom, adjustable from 130 à 180 mm	
U90950461	Multiplex waste/overflow combination, chrome	
UCCON0475	Pipe interruptor, incl. connections	
U90600361	Multiplex Trio Outlet/overflow fitting with water inlet, chrome	
U90600461	Multiplex Trio Outlet/overflow fitting with water inlet and pipe interrupter, chrome	
U90170061	Handgrips, 1 pair = 2 grips, chrome	
U906100XX	Multifunction cushion, foam, 240 x 150 x 50 mm	

Preassembled bath options in combination with: For order form, see fold-out page on the right-hand side	only bath	Airpools		Hydropools		Combipools		Special Combipools	
		AE	AC	HE	HC	CE	CC	IP	AP
Profibox 2.0 alcove	<input type="radio"/>	<input type="radio"/>	<input type="radio"/>	<input type="radio"/>	<input type="radio"/>	<input type="radio"/>	<input type="radio"/>	<input type="radio"/>	-
Profibox 2.0 corner	<input type="radio"/>	<input type="radio"/>	<input type="radio"/>	<input type="radio"/>	<input type="radio"/>	<input type="radio"/>	<input type="radio"/>	<input type="radio"/>	-
TouchLight	<input type="radio"/>	-	-	-	-	-	-	-	-

Whirlpool Systems	Article number	Description	Airpools		Hydropools		Combipools		Special Combipools	
			AE	AC	HE	HC	CE	CC	IP	AP
	U__ 178 ARA 2A ½ V XX	Price of whirlpool system incl. bath								
	U__ 178 ARA 2B ½ V XX	Price of whirlpool system incl. bath incl. Multiplex Trio								

For the following whirlpool systems the technology protrudes:

Technical parts 1	Side 1-2	Side 1-3	Side 2-4	Airpools		Hydropools		Combipools		Special Combipools	
				AE	AC	HE	HC	CE	CC	IP	AP
Technical parts 2	Side 1-2	-	-	-	-	-	-	-	-	-	+5
	Side 1-3	-	-	-	-	-	-	-	-	-	+10
	Side 2-4	-	-	-	-	-	-	-	-	-	+10

Please replace __ in article number with whirlpool code.

Please replace ½ in article number with desired position of technical equipment (1 = Layout 1, 2 = Layout 2). The back jets are located at the end at which the technical equipment is installed.

For further options use the order form (see right-hand fold-out page)

Technical parts 1

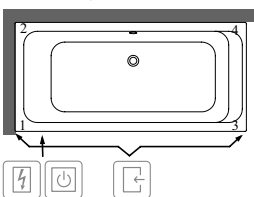

Technical parts 2

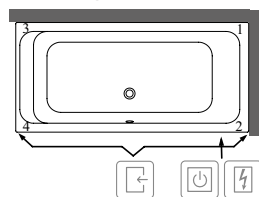

- Accessible via
- Control box
- Rim control

This symbol "O" means this option is possible

XX = Colour code to be indicated

For further information on colours, please see the page at the beginning of this section.

Further information on whirlpool systems please see page 585.

ARCHITECTURA Duo (Rectangle 1800 x 800) Acrylic

€ excl. VAT

Not included in scope of delivery: Set of bath feet is not supplied as standard.
Matching sanitary ceramics: Architectura

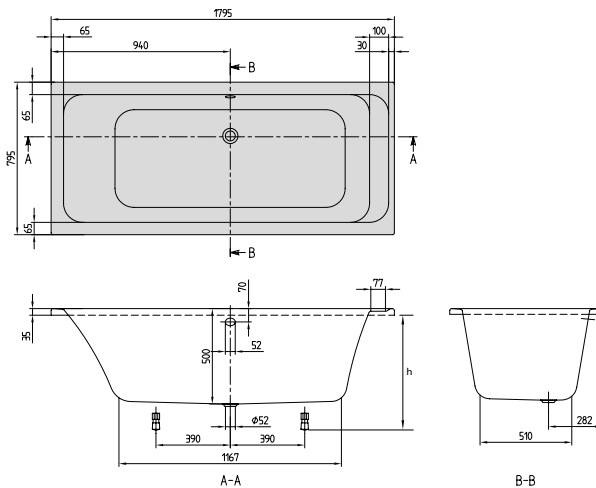

h = Installation height (min - max)	
Bath	605 - 655
Whirlpool system	645 - 685
Profibox 2.0 without system	625 - 625
Profibox 2.0 incl. System	625 - 625

Article number	Description	Size l x w	Bottom l x w	Depth	Litres incl. 1 pers	Weight (kg)	01	pcs/pal.
UBA 180 ARA 2V-XX	Architectura	1800 x 800	1200 x 430	500	235	25		10

Accessories for baths:

Article number	Description	Price
U99740000	Bath feet, plastic, for baths with even bottom, adjustable from 130 à 180 mm	
U90950461	Multiplex waste/overflow combination, chrome	
UCCON0475	Pipe interruptor, incl. connections	
U90600361	Multiplex Trio Outlet/overflow fitting with water inlet, chrome	
U90600461	Multiplex Trio Outlet/overflow fitting with water inlet and pipe interruptor, chrome	
U90170061	Handgrips, 1 pair = 2 grips, chrome	
U906100XX	Multifunction cushion, foam, 240 x 150 x 50 mm	

Preassembled bath options in combination with: For order form, see fold-out page on the right-hand side	only bath	Airpools		Hydropools		Combipools		Special Combipools	
		AE	AC	HE	HC	CE	CC	IP	AP
Profibox 2.0 alcove	○	○	○	○	○	○	○	○	-
Profibox 2.0 corner	○	○	○	○	○	○	○	○	-
TouchLight	○	-	-	-	-	-	-	-	-

Whirlpool Systems	Article number	Description	Airpools		Hydropools		Combipools		Special Combipools	
			AE	AC	HE	HC	CE	CC	IP	AP
	U__ 180 ARA 2A ½ V XX	Price of whirlpool system incl. bath								
	U__ 180 ARA 2B ½ V XX	Price of whirlpool system incl. bath incl. Multiplex Trio								

For the following whirlpool systems the technology protrudes:

Technical parts	Side	AE	AC	HE	HC	CE	CC	IP	AP
Technical parts 1	Side 1-3	-	-	-	-	-	-	-	+5
	Side 2-4	-	-	-	-	-	-	-	+5
Technical parts 2	Side 1-3	-	-	-	-	-	-	-	+5
	Side 2-4	-	-	-	-	-	-	-	+5

Please replace __ in article number with whirlpool code.

Please replace ½ in article number with desired position of technical equipment (1 = Layout 1, 2 = Layout 2). The back jets are located at the end at which the technical equipment is installed.

For further options use the order form (see right-hand fold-out page)

Technical parts 1

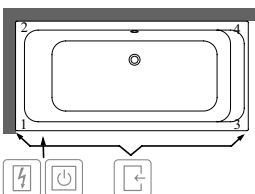

Technical parts 2

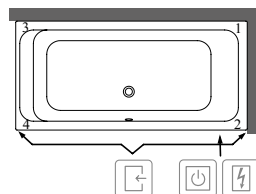

-  Accessible via
-  Control box
-  Rim control

This symbol "○" means this option is possible

XX = Colour code to be indicated

For further information on colours, please see the page at the beginning of this section.

Further information on whirlpool systems please see page 585.

ARCHITECTURA Duo (Rectangle 1900 x 900) Acrylic

€ excl. VAT

Not included in scope of delivery: Set of bath feet is not supplied as standard.
Matching sanitary ceramics: Architectura

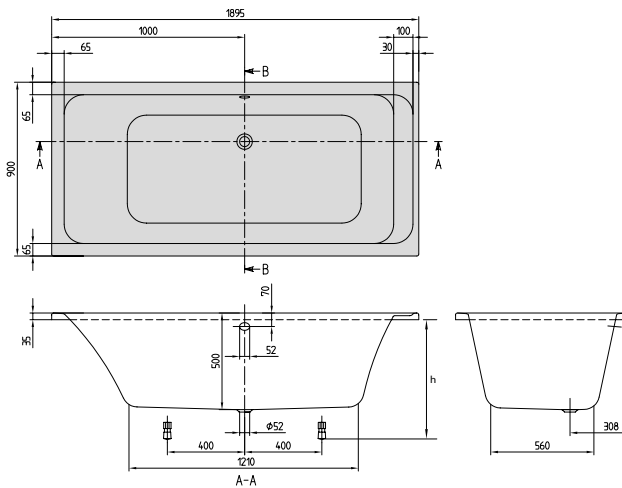

h = Installation height (min - max)	
Bath	605 - 655
Whirlpool system	645 - 685
Profibox 2.0 without system	625 - 625
Profibox 2.0 incl. System	625 - 625

Article number	Description	Size l x w	Bottom l x w	Depth	Litres incl. 1 pers	Weight (kg)	01	pcs/pal.
UBA 199 ARA 2V-XX	Architectura	1900 x 900	1210 x 560	500	285	27		10

Accessories for baths:

Article number	Description	Price
U99740000	Bath feet, plastic, for baths with even bottom, adjustable from 130 à 180 mm	
U90950461	Multiplex waste/overflow combination, chrome	
UCCON0475	Pipe interruptor, incl. connections	
U90600361	Multiplex Trio Outlet/overflow fitting with water inlet, chrome	
U90600461	Multiplex Trio Outlet/overflow fitting with water inlet and pipe interruptor, chrome	
U90170061	Handgrips, 1 pair = 2 grips, chrome	
U906100XX	Multifunction cushion, foam, 240 x 150 x 50 mm	

Preassembled bath options in combination with: For order form, see fold-out page on the right-hand side	only bath	Airpools		Hydropools		Combipools		Special Combipools	
		AE	AC	HE	HC	CE	CC	IP	AP
Profibox 2.0 alcove	<input type="radio"/>	<input type="radio"/>	<input type="radio"/>	<input type="radio"/>	<input type="radio"/>	<input type="radio"/>	<input type="radio"/>	<input type="radio"/>	<input type="radio"/>
Profibox 2.0 corner	<input type="radio"/>	<input type="radio"/>	<input type="radio"/>	<input type="radio"/>	<input type="radio"/>	<input type="radio"/>	<input type="radio"/>	<input type="radio"/>	<input type="radio"/>
TouchLight	<input type="radio"/>	-	-	-	-	-	-	-	-

Whirlpool Systems		Airpools		Hydropools		Combipools		Special Combipools	
Article number	Description	AE	AC	HE	HC	CE	CC	IP	AP
U__ 199 ARA 2A ½ V XX	Price of whirlpool system incl. bath								
U__ 199 ARA 2B ½ V XX	Price of whirlpool system incl. bath incl. Multiplex Trio								

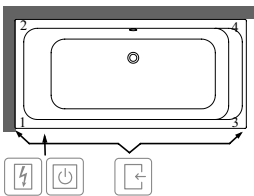

Please replace __ in article number with whirlpool code.
 Please replace ½ in article number with desired position of technical equipment (1 = Layout 1, 2 = Layout 2). The back jets are located at the end at which the technical equipment is installed.
For further options use the order form (see right-hand fold-out page)

Technical parts 1

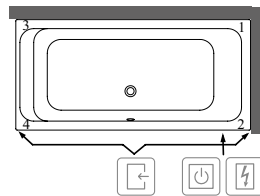

Technical parts 2



-  Accessible via
-  Control box
-  Rim control

This symbol "O" means this option is possible

XX = Colour code to be indicated

For further information on colours, please see the page at the beginning of this section.

Further information on whirlpool systems please see page 585.

AVEO (Oval 1900 x 950) Quarry[®]

€ excl. VAT

Included in scope of delivery:

Set of bath feet is supplied as standard (self-adhesive), adjustable from 130 à 180 mm.

Not included in scope of delivery:

Requires extended waste/overflow combination.

Technical information:

The whirlpool system IP (Special Combipool Invisible) for baths in color Stone White (RW) will be delivered with Stone White (RW) colored jets. For all other pools in the color RW, the jets remain in Chrome.

Price for whirlpool system in the colour Stone White (RW) on request.

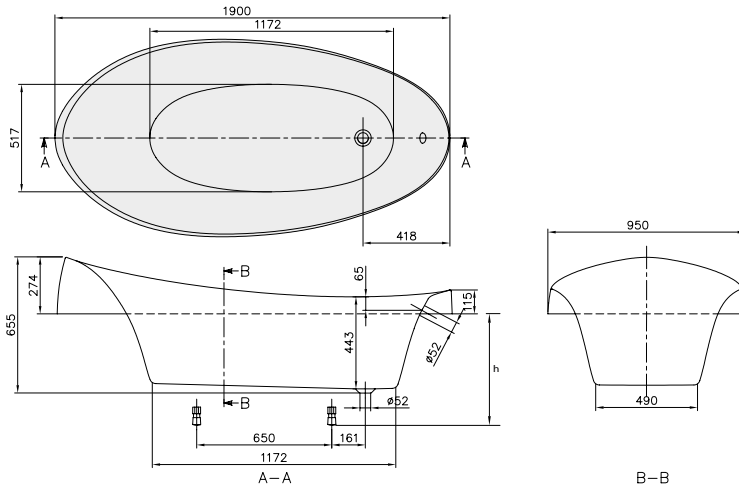

Quarry[®]

h = Installation height (min - max)	
Bath	490 - 540
Whirlpool system	520 - 570

Article number	Description	Size l x w	Bottom l x w	Depth	Litres incl. 1 pers	Weight (kg)	01	RW	pcs/pal.
UBQ 194 AVE 7V-XX	Aveo, built-in version	1900 x 950	1170 x 540	443	245	50,8			1

Accessories for baths:

Article number	Description	Price
U90950461	Multiplex waste/overflow combination, chrome	
UCCON0475	Pipe interruptor, incl. connections	
U90600361	Multiplex Trio Outlet/overflow fitting with water inlet, chrome	
U90600461	Multiplex Trio Outlet/overflow fitting with water inlet and pipe interruptor, chrome	
U906100XX	Multifunction cushion, foam, 240 x 150 x 50 mm	

Preassembled bath options in combination with: For order form, see fold-out page on the right-hand side		only bath	Airpools		Hydropools		Combipools		Special Combipools	
			AE	AC	HE	HC	CE	CC	IP	AP
TouchLight		○	-	-	-	-	-	-	-	-

Whirlpool Systems		Airpools		Hydropools		Combipools		Special Combipools	
Article number	Description	AE	AC	HE	HC	CE	CC	IP	AP
U__194 AVE 7A ½ V XX	Price of whirlpool system incl. bath								
U__194 AVE 7B ½ V XX	Price of whirlpool system incl. bath incl. Multiplex Trio								

For the following whirlpool systems the technology protrudes:

Technical parts 1	Side 1-2	Side 1-3	Side 2-4	Technical parts 2	Side 1-2	Side 1-3	Side 2-4
	-	-	-		-	-	-
	-	-	-		-	-	-
	-	-	-		-	-	-
	-	-	-		-	-	-
	-	-	-		-	-	-
	-	-	-		-	-	-

Please replace __ in article number with whirlpool code.

Please replace ½ in article number with desired position of technical equipment (1 = Layout 1, 2 = Layout 2). The back jets are located at the end at which the technical equipment is installed.

For further options use the order form (see right-hand fold-out page)

Technical parts 1

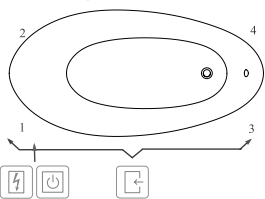

Technical parts 2

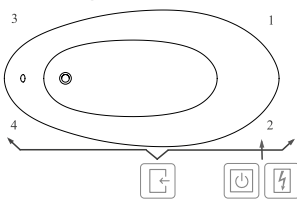

- Accessible via
- Control box
- Rim control

This symbol "○" means this option is possible

XX = Colour code to be indicated

For further information on colours, please see the page at the beginning of this section.

Further information on whirlpool systems please see page 585.

AVEO (Free-standing 1900 x 950) Quarryl®

€ excl. VAT

Included in scope of delivery:

Matching outlet and overflow (Chrome) is supplied as standard.

Technical information:

Bath and panel are of the material Quarryl® (2 parts). Panel is also the frame (Height of the panel: 555 mm).

Whirlpool systems available on request.

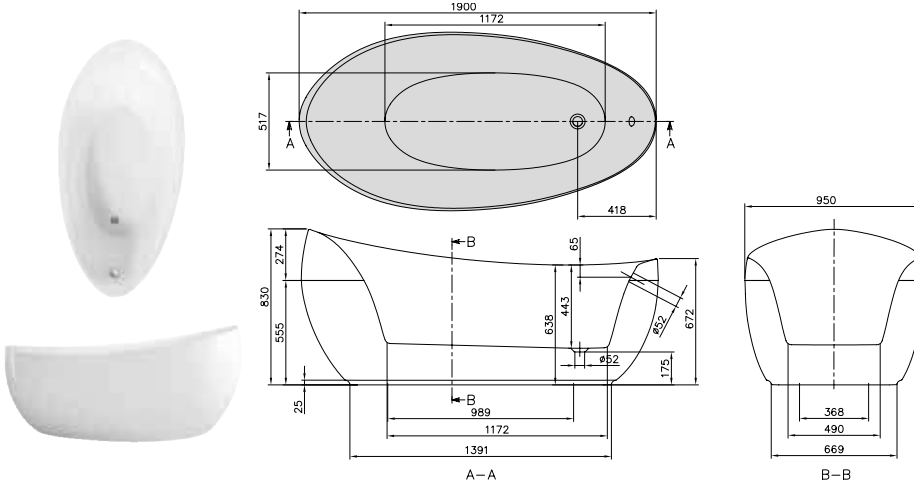

Article number	Description	Size l x w	Bottom l x w	Depth	Litres incl. 1 pers	Weight (kg)	01	RW	pcs/pal.
UBQ 194 AVE 9PDV-XX	Aveo, freestanding, incl. Quarryl® panel in the same colour as the bath, incl. waste/overflow chrome-plated	1900 x 950	1170 x 540	443	245	98,4			1

Accessories for baths:

Article number	Description	Price
UCCON0475	Pipe interruptor, incl. connections	
U90600361	Multiplex Trio Outlet/overflow fitting with water inlet, chrome	
U90600461	Multiplex Trio Outlet/overflow fitting with water inlet and pipe interruptor, chrome	
U906100XX	Multifunction cushion, foam, 240 x 150 x 50 mm	

Preassembled bath options in combination with:

For order form, see fold-out page on the right-hand side

TouchLight	Price

XX = Colour code to be indicated
 For further information on colours, please see the page at the beginning of this section.
 Further information on whirlpool systems please see page 585.

AVEO NEW GENERATION (Free-standing 1900 x 950) Quarryl®

€ excl. VAT

Included in scope of delivery: Matching outlet and overflow (Chrome) is supplied as standard.

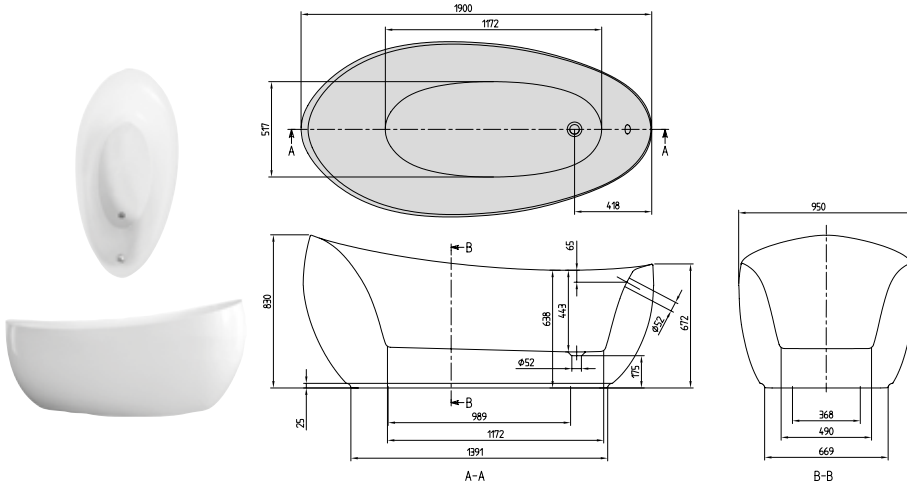

Quarryl®

Article number	Description	Size l x w	Bottom l x w	Depth	Litres incl. 1 pers	Weight (kg)	01	RW	pcs/pal.
UBQ 194 AVE 9W1V-XX	Aveo New Generation, freestanding, seamless, incl. pre-fitted outlet and overflow (chrome plated)	1900 x 950	1170 x 540	443	245	97,9			1
UBQ 194 AVE 9T1V-XX	Aveo New Generation, freestanding, seamless, incl. pre-fitted Multiplex Trio (chrome plated)								1

Accessories for baths:

Article number	Description	Price
UCCON0475	Pipe interruptor, incl. connections	
U906100XX	Multifunction cushion, foam, 240 x 150 x 50 mm	

XX = Colour code to be indicated
 For further information on colours, please see the page at the beginning of this section.
 Further information on whirlpool systems please see page 585.

BATHS

AVEO NEW GENERATION (Free-standing 1900 x 950) Quarry[®], Colour on Demand

€ excl. VAT

Included in scope of delivery: Matching outlet and overflow (Chrome) is supplied as standard.

Quarry[®]

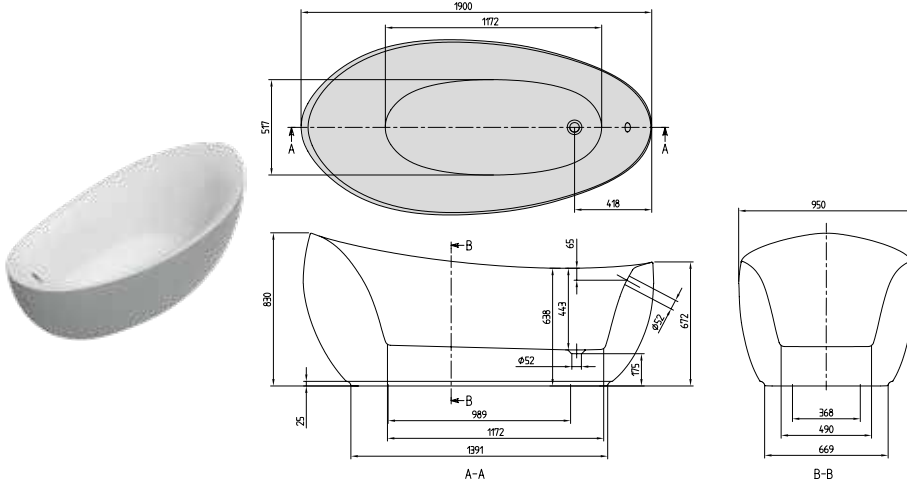

Article number	Description	Size l x w	Bottom l x w	Depth	Litres incl. 1 pers	Weight (kg)	01	RW	pcs/pal.
UBQ 194 AVE 9W1BCV-XX	Aveo New Generation, freestanding, seamless, Colour on Demand (Quarry [®]), incl. pre-fitted outlet and overflow (chrome plated)	1900 x 950	1170 x 540	443	245	97,9			1
UBQ 194 AVE 9T1BCV-XX	Aveo New Generation, freestanding, seamless, Colour on Demand (Quarry [®]), incl. pre-fitted Multiplex Trio (chrome plated)								1

Accessories for baths:

Article number	Description	Price
UCCON0475	Pipe interruptor, incl. connections	
U906100XX	Multifunction cushion, foam, 240 x 150 x 50 mm	

Made-to-order production - Colour on Demand: 3 week delivery period. Please make sure to use the **order form** that you will find immediately after the chapter on baths on page 578-579, so that we can complete the order for you.

XX = Colour code to be indicated
 For further information on colours, please see the page at the beginning of this section.
 Further information on whirlpool systems please see page 585.

CETUS Duo (Rectangle 1800 x 800) Quarry[®]

€ excl. VAT

Included in scope of delivery:

Set of bath feet is supplied as standard (self-adhesive), adjustable from 130 à 180 mm.

Not included in scope of delivery:

Requires extended waste/overflow combination.

Technical information:

Whirlpool systems available on request.

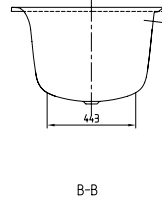
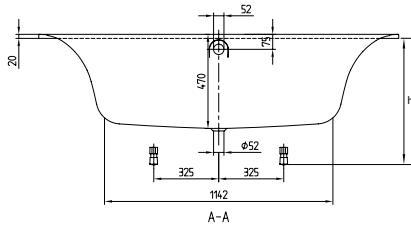
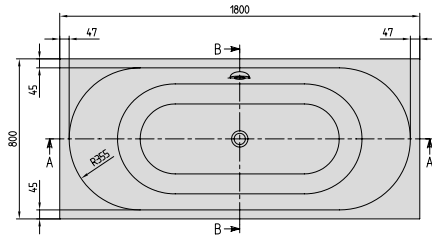

h = Installation height (min - max)	
Bath	605 - 655
UNITED without system	575 - 660

Article number	Description	Size l x w	Bottom l x w	Depth	Litres incl. 1 pers	Weight (kg)	01	pcs/pal.
UBQ 180 CEU 2V-XX	Cetus	1800 x 800	1140 x 480	471	170	44,6		8

Accessories for baths:

Article number	Description	Price
U90950461	Multiplex waste/overflow combination, chrome	
UCCON0475	Pipe interruptor, incl. connections	
U90600361	Multiplex Trio Outlet/overflow fitting with water inlet, chrome	
U90600461	Multiplex Trio Outlet/overflow fitting with water inlet and pipe interrupter, chrome	
U90170061	Handgrips, 1 pair = 2 grips, chrome	
U906100XX	Multifunction cushion, foam, 240 x 150 x 50 mm	

Preassembled bath options in combination with:

For order form, see fold-out page on the right-hand side

	Price
UNITED Free-standing	
UNITED Corner	
TouchLight	

XX = Colour code to be indicated
 For further information on colours, please see the page at the beginning of this section.
 Further information on whirlpool systems please see page 585.

BATHS

CETUS Duo (Oval 1750 x 750) Quarryl®

€ excl. VAT

Included in scope of delivery:

Set of bath feet is supplied as standard (self-adhesive), adjustable from 130 à 180 mm.

Not included in scope of delivery:

Requires extended waste/overflow combination.

Technical information:

Whirlpool systems available on request.

BATHS

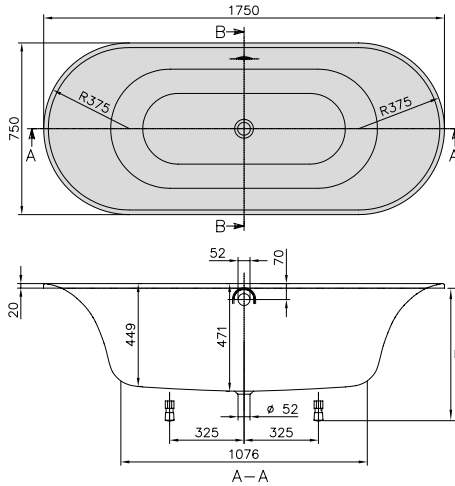

Quarryl®

h = Installation height (min - max)	
Bath	605 - 655

Article number	Description	Size l x w	Bottom l x w	Depth	Litres incl. 1 pers	Weight (kg)	01	pcs/pal.
UBQ 175 CEU 7V-XX	Cetus	1750 x 750	1080 x 460	471	140	31,8		8

Accessories for baths:

Article number	Description	Price
U90950461	Multiplex waste/overflow combination, chrome	
UCCON0475	Pipe interruptor, incl. connections	
U90600361	Multiplex Trio Outlet/overflow fitting with water inlet, chrome	
U90600461	Multiplex Trio Outlet/overflow fitting with water inlet and pipe interrupter, chrome	
U906100XX	Multifunction cushion, foam, 240 x 150 x 50 mm	

Preassembled bath options in combination with:

For order form, see fold-out page on the right-hand side

TouchLight

Price

XX = Colour code to be indicated
 For further information on colours, please see the page at the beginning of this section.
 Further information on whirlpool systems please see page 585.

COLLARO BATH

€ excl. VAT

Acrylic baths with colour-coordinated outlet and overflow fittings



- Suitable for bathrooms of all sizes thanks to the varied installation options:
- Built-in baths in 160x75 cm, 170x75 cm, 180x80 cm and 190x90 cm
- Back-to-wall and corner baths in 180x80 cm
- Premium design with the first Villeroy&Boch monolithic baths in acrylic
- Perfect in combination with the Collaro washbasins thanks to the cross-collection design

BATHS

Individual combination possibilities



Push-to-Open valve and integrated overflow supplied as standard in the colour Chrome



Outlet and overflow fittings to match Villeroy & Boch tap fittings are available in Chrome, Black Matt, Gold or Champagne



Water inlet, integrated in the overflow as an option

Bath colours



White Alpin RW Stone White

Metal colours

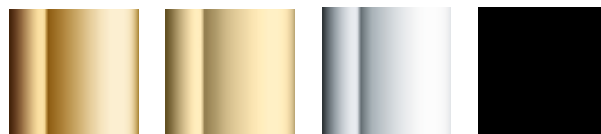

Gold Champagne Chrome Black Matt

Colour on Demand option



Order form p. 578-579

COLLARO BATH (WALL-FACING)

€ excl. VAT

This is how to order the right wall-facing Collaro bath

The article number for the wall-facing Collaro bath consists of the following:

UBA 180 COR 9 __ ZZ V Y XX

Please note that for reasons of space, the hyphen before the colour number "XX" is replaced by a different number "Y". Insert D, E, J or N directly after the "V" for corner and back-to-wall baths.
 Note: Built-in baths can be ordered as usual.

Step 1: Please replace __ in the article number with the relevant built-in variant code:

- CS = Wall-facing bath 180 x 80 cm
- CL = Wall-facing bath, left-hand model 180 x 80 cm
- CR = Wall-facing bath, right-hand model 180 x 80 cm

Step 2: Please replace ZZ in the article number with the colour option:

- BC = With Bicolour option (see order form with Colour on Demand on page 578-579)
- 00 = Without Bicolour option

Step 3: Please replace Y in the article number with the colour option for the outlet and overflow fittings:

- D = Chrome outlet and overflow fittings
- E = Champagne outlet and overflow fittings
- J = Gold outlet and overflow fittings
- N = Black Matt outlet and overflow fittings

Step 4: Please replace XX in the article number with the colour of the bath:

- 01 = White Alpin
- RW = Stone White

Example:

Article number	Description
UBA 180 COR 9CSBCVJ XX	Collaro, wall-facing, Colour on Demand, Gold

COLLARO Duo (Rectangle 1600 x 750) Acrylic

€ excl. VAT

Included in scope of delivery: Matching outlet and overflow is supplied as standard.
Not included in scope of delivery: Set of bath feet is not supplied as standard.
Technical information: The whirlpool system IP (Special Combipool Invisible) for baths in color Stone White (RW) will be delivered with Stone White (RW) colored jets. For all other pools in the color RW, the jets remain in Chrome.
 Note: central positioning of the tap fitting is not possible.
Matching sanitary ceramics: Collaro
Matching furniture programme: Collaro

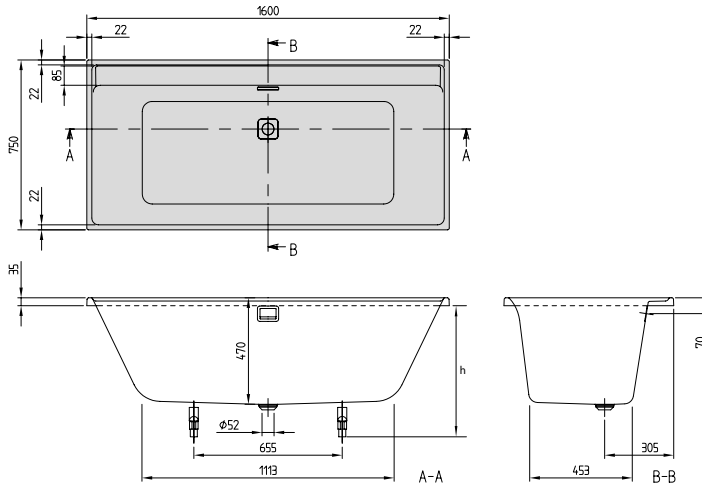

h = Installation height (min - max)	
Bath	580 - 622
Whirlpool system	620 - 650
Profibox 2.0 without system	585
Profibox 2.0 incl. System	625

Article number	Description	Size l x w	Bottom l x w	Depth	Litres incl. 1 pers	Weight (kg)	01	RW	pcs/pat.
UBA 160 COR 2DV-XX	Collaro, built-in version, Chrome	1600 x 750	1113 x 453	470	181	21			10
UBA 160 COR 2EV-XX	Collaro, built-in version, Champagne								10
UBA 160 COR 2JV-XX	Collaro, built-in version, Gold								10
UBA 160 COR 2NV-XX	Collaro, built-in version, Black Matt								10

Accessories for baths:

Article number	Description	Price
U99740000	Bath feet, plastic, for baths with even bottom, adjustable from 130 à 180 mm	
UCCON0475	Pipe interruptor, incl. connections	
UPCON0137	Water inlet, plastic, integrated in the overflow, maximum water flow rate: 20 l/min	
U90170061	Handgrips, 1 pair = 2 grips, chrome	
U906100XX	Multifunction cushion, foam, 240 x 150 x 50 mm	

Preassembled bath options in combination with:

For order form, see fold-out page on the right-hand side	only bath	Airpools		Hydropools		Combipools		Special Combipools	
		AE	AC	HE	HC	CE	CC	IP	AP
Profibox 2.0 alcove	<input type="radio"/>	<input type="radio"/>	<input type="radio"/>	<input type="radio"/>	<input type="radio"/>	<input type="radio"/>	<input type="radio"/>	<input type="radio"/>	<input type="radio"/>
Profibox 2.0 corner	<input type="radio"/>	<input type="radio"/>	<input type="radio"/>	<input type="radio"/>	<input type="radio"/>	<input type="radio"/>	<input type="radio"/>	<input type="radio"/>	<input type="radio"/>
TouchLight	<input type="radio"/>	-	-	-	-	-	-	-	-

Whirlpool Systems

Article number	Description	Airpools		Hydropools		Combipools		Special Combipools	
		AE	AC	HE	HC	CE	CC	IP	AP
U__ 160 COR 2A ½ V 01	Price of whirlpool system incl. bath								
U__ 160 COR 2A ½ V RW	Price of whirlpool system incl. bath								
U__ 160 COR 2B ½ V 01	Price of whirlpool system incl. bath incl. water inlet								
U__ 160 COR 2B ½ V RW	Price of whirlpool system incl. bath incl. water inlet								

For the following whirlpool systems the technology protrudes:

Technical parts 1	Side 2-4	-	-	-	+10	-	+10	+15	35
Technical parts 2	Side 2-4	-	-	-	+10	-	+10	+15	35

Please replace __ in article number with whirlpool code.

Please replace ½ in article number with desired position of technical equipment (1 = Layout 1, 2 = Layout 2). The back jets are located at the end at which the technical equipment is installed.

For further options use the order form (see right-hand fold-out page)

Technical parts 1

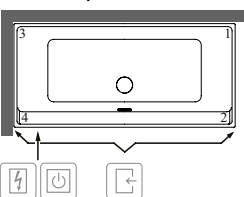

Technical parts 2

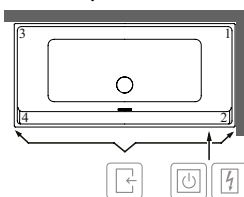

- Accessible via
- Control box
- Rim control

This symbol "O" means this option is possible

XX = Colour code to be indicated

For further information on colours, please see the page at the beginning of this section.

Further information on whirlpool systems please see page 585.

COLLARO Duo (Rectangle 1700 x 750) Acrylic

€ excl. VAT

Included in scope of delivery: Matching outlet and overflow is supplied as standard.
Not included in scope of delivery: Set of bath feet is not supplied as standard.
Technical information: The whirlpool system IP (Special Combipool Invisible) for baths in color Stone White (RW) will be delivered with Stone White (RW) colored jets. For all other pools in the color RW, the jets remain in Chrome.
 Note: central positioning of the tap fitting is not possible.
Matching sanitary ceramics: Collaro
Matching furniture programme: Collaro

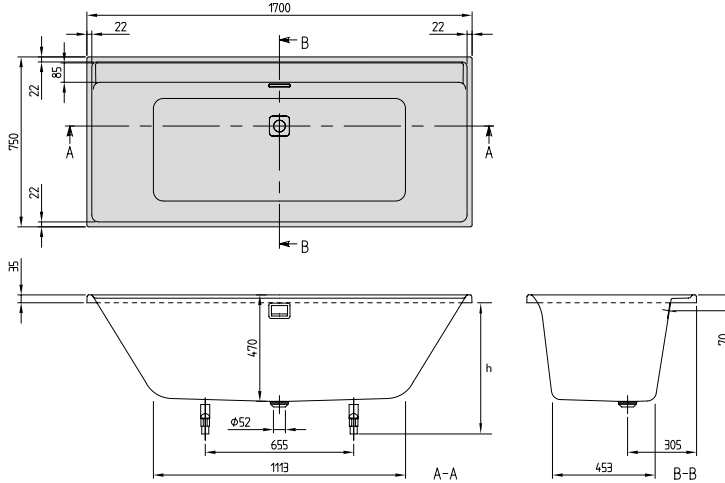

h = Installation height (min - max)	
Bath	580 - 622
Whirlpool system	620 - 650
Profibox 2.0 without system	585
Profibox 2.0 incl. System	625

Article number	Description	Size l x w	Bottom l x w	Depth	Litres incl. 1 pers	Weight (kg)	01	RW	pcs/pat.
UBA 170 COR 2DV-XX	Collaro, built-in version, Chrome	1700 x 750	1114 x 453	470	190	22			10
UBA 170 COR 2EV-XX	Collaro, built-in version, Champagne								10
UBA 170 COR 2JV-XX	Collaro, built-in version, Gold								10
UBA 170 COR 2NV-XX	Collaro, built-in version, Black Matt								10

Accessories for baths:

Article number	Description	Price
U99740000	Bath feet, plastic, for baths with even bottom, adjustable from 130 à 180 mm	
UCCON0475	Pipe interruptor, incl. connections	
UPCON0137	Water inlet, plastic, integrated in the overflow, maximum water flow rate: 20 l/min	
U90170061	Handgrips, 1 pair = 2 grips, chrome	
U906100XX	Multifunction cushion, foam, 240 x 150 x 50 mm	

Preassembled bath options in combination with:

For order form, see fold-out page on the right-hand side	only bath	Airpools		Hydropools		Combipools		Special Combipools	
		AE	AC	HE	HC	CE	CC	IP	AP
Profibox 2.0 alcove	○	-	-	-	-	-	-	-	-
Profibox 2.0 corner	○	-	-	-	-	-	-	-	-
TouchLight	○	-	-	-	-	-	-	-	-

Whirlpool Systems

Article number	Description	Airpools		Hydropools		Combipools		Special Combipools	
		AE	AC	HE	HC	CE	CC	IP	AP
U__ 170 COR 2A ½ V 01	Price of whirlpool system incl. bath								
U__ 170 COR 2A ½ V RW	Price of whirlpool system incl. bath								
U__ 170 COR 2B ½ V 01	Price of whirlpool system incl. bath incl. water inlet								
U__ 170 COR 2B ½ V RW	Price of whirlpool system incl. bath incl. water inlet								

For the following whirlpool systems the technology protrudes:

Technical parts 1	Side 2-4	-	-	-	+10	-	+10	+15	+30
Technical parts 2	Side 2-4	-	-	-	+10	-	+10	+15	+30

Please replace __ in article number with whirlpool code.

Please replace ½ in article number with desired position of technical equipment (1 = Layout 1, 2 = Layout 2). The back jets are located at the end at which the technical equipment is installed.

For further options use the order form (see right-hand fold-out page)

Technical parts 1

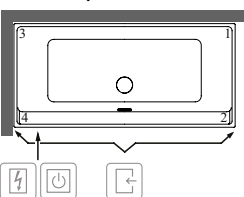

Technical parts 2

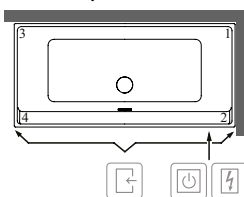

- Accessible via
- Control box
- Rim control

This symbol "O" means this option is possible

XX = Colour code to be indicated

For further information on colours, please see the page at the beginning of this section.

Further information on whirlpool systems please see page 585.

COLLARO Duo (Rectangle 1800 x 800) Acrylic

€ excl. VAT

Included in scope of delivery:

Matching outlet and overflow is supplied as standard.

Not included in scope of delivery:

Set of bath feet is not supplied as standard.

Technical information:

The whirlpool system IP (Special Combipool Invisible) for baths in color Stone White (RW) will be delivered with Stone White (RW) colored jets. For all other pools in the color RW, the jets remain in Chrome.

Note: central positioning of the tap fitting is not possible.

Matching sanitary ceramics:

Collaro

Matching furniture programme:

Collaro

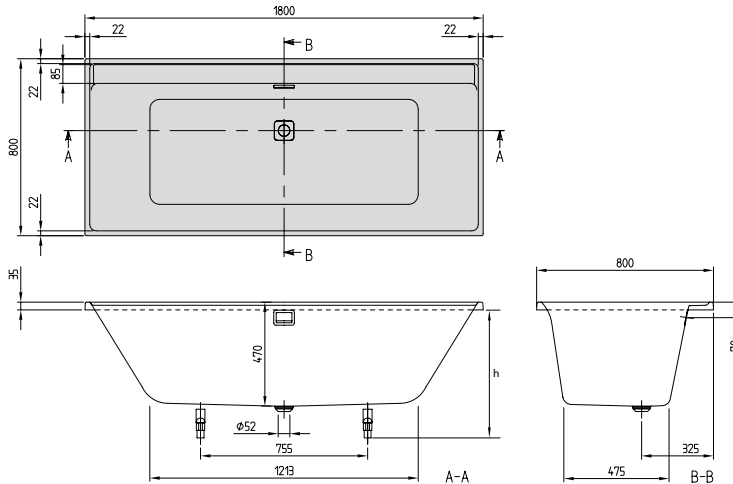

h = Installation height (min - max)	
Bath	580 - 622
Whirlpool system	620 - 650
Profibox 2.0 without system	585
Profibox 2.0 incl. System	625

Article number	Description	Size l x w	Bottom l x w	Depth	Litres incl. 1 pers	Weight (kg)	01	RW	pcs/pat.
UBA 180 COR 2DV-XX	Collaro, built-in version, Chrome	1800 x 800	1213 x 475	470	190	24			10
UBA 180 COR 2EV-XX	Collaro, built-in version, Champagne								10
UBA 180 COR 2JV-XX	Collaro, built-in version, Gold								10
UBA 180 COR 2NV-XX	Collaro, built-in version, Black Matt								10

Accessories for baths:

Article number	Description	Price
U99740000	Bath feet, plastic, for baths with even bottom, adjustable from 130 à 180 mm	
UCCON0475	Pipe interruptor, incl. connections	
UPCON0137	Water inlet, plastic, integrated in the overflow, maximum water flow rate: 20 l/min	
U90170061	Handgrips, 1 pair = 2 grips, chrome	
U906100XX	Multifunction cushion, foam, 240 x 150 x 50 mm	

Preassembled bath options in combination with: For order form, see fold-out page on the right-hand side	only bath	Airpools		Hydropools		Combipools		Special Combipools	
		AE	AC	HE	HC	CE	CC	IP	AP
Profibox 2.0 alcove	<input type="radio"/>	-	-	-	-	-	-	-	-
Profibox 2.0 corner	<input type="radio"/>	-	-	-	-	-	-	-	-
TouchLight	<input type="radio"/>	-	-	-	-	-	-	-	-

Whirlpool Systems	Article number	Description	Airpools		Hydropools		Combipools		Special Combipools	
			AE	AC	HE	HC	CE	CC	IP	AP
	U__ 180 COR 2A ½ V 01	Price of whirlpool system incl. bath								
	U__ 180 COR 2A ½ V RW	Price of whirlpool system incl. bath								
	U__ 180 COR 2B ½ V 01	Price of whirlpool system incl. bath incl. water inlet								
	U__ 180 COR 2B ½ V RW	Price of whirlpool system incl. bath incl. water inlet								

For the following whirlpool systems the technology protrudes:

Technical parts 1	Side 2-4	-	-	-	+5	-	+5	+10	+25
Technical parts 2	Side 2-4	-	-	-	+5	-	+5	+10	+25

Please replace __ in article number with whirlpool code.

Please replace ½ in article number with desired position of technical equipment (1 = Layout 1, 2 = Layout 2). The back jets are located at the end at which the technical equipment is installed.

For further options use the order form (see right-hand fold-out page)

Technical parts 1

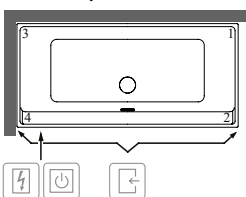

Technical parts 2

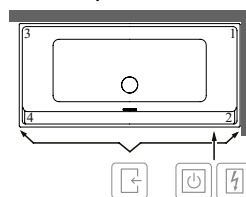

- Accessible via
- Control box
- Rim control

This symbol "O" means this option is possible

XX = Colour code to be indicated

For further information on colours, please see the page at the beginning of this section.

Further information on whirlpool systems please see page 585.

COLLARO Duo (Rectangle 1900 x 900) Acrylic

€ excl. VAT

Included in scope of delivery: Matching outlet and overflow is supplied as standard.
Not included in scope of delivery: Set of bath feet is not supplied as standard.
Technical information: The whirlpool system IP (Special Combipool Invisible) for baths in color Stone White (RW) will be delivered with Stone White (RW) colored jets. For all other pools in the color RW, the jets remain in Chrome.
 Note: central positioning of the tap fitting is not possible.
Matching sanitary ceramics: Collaro
Matching furniture programme: Collaro

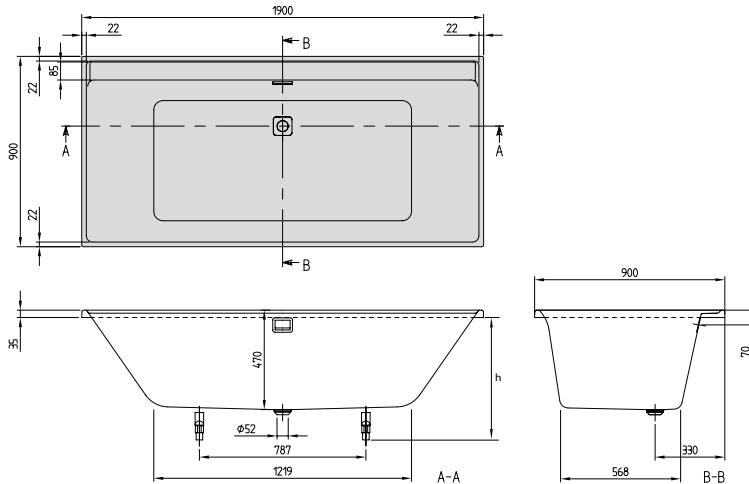

h = Installation height (min - max)	
Bath	580 - 622
Whirlpool system	620 - 650
Profibox 2.0 without system	585
Profibox 2.0 incl. System	625

Article number	Description	Size l x w	Bottom l x w	Depth	Litres incl. 1 pers	Weight (kg)	01	RW	pcs/pat.
UBA 199 COR 2DV-XX	Collaro, built-in version, Chrome	1900 x 900	1219 x 568	470	287	26			10
UBA 199 COR 2EV-XX	Collaro, built-in version, Champagne								10
UBA 199 COR 2JV-XX	Collaro, built-in version, Gold								10
UBA 199 COR 2NV-XX	Collaro, built-in version, Black Matt								10

Accessories for baths:

Article number	Description	Price
U99740000	Bath feet, plastic, for baths with even bottom, adjustable from 130 à 180 mm	
UCCON0475	Pipe interruptor, incl. connections	
UPCON0137	Water inlet, plastic, integrated in the overflow, maximum water flow rate: 20 l/min	
U90170061	Handgrips, 1 pair = 2 grips, chrome	
U906100XX	Multifunction cushion, foam, 240 x 150 x 50 mm	

Preassembled bath options in combination with: For order form, see fold-out page on the right-hand side	only bath	Airpools		Hydropools		Combipools		Special Combipools	
		AE	AC	HE	HC	CE	CC	IP	AP
Profibox 2.0 alcove	○	-	-	-	-	-	-	-	-
Profibox 2.0 corner	○	-	-	-	-	-	-	-	-
TouchLight	○	-	-	-	-	-	-	-	-

Whirlpool Systems	Description	Airpools		Hydropools		Combipools		Special Combipools	
		AE	AC	HE	HC	CE	CC	IP	AP
U__ 199 COR 2A ½ V 01	Price of whirlpool system incl. bath								
U__ 199 COR 2A ½ V RW	Price of whirlpool system incl. bath								
U__ 199 COR 2B ½ V 01	Price of whirlpool system incl. bath incl. water inlet								
U__ 199 COR 2B ½ V RW	Price of whirlpool system incl. bath incl. water inlet								

For the following whirlpool systems the technology protrudes:

Technical parts 1	Side 2-4	-	-	-	+5	-	+5	+10	+30
Technical parts 2	Side 2-4	-	-	-	+5	-	+5	+10	+30

Please replace __ in article number with whirlpool code.

Please replace ½ in article number with desired position of technical equipment (1 = Layout 1, 2 = Layout 2). The back jets are located at the end at which the technical equipment is installed.

For further options use the order form (see right-hand fold-out page)

Technical parts 1

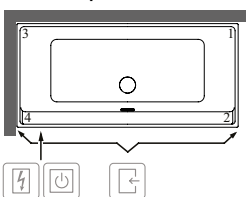

Technical parts 2

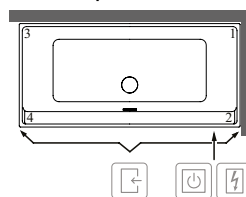

- Accessible via
- Control box
- Rim control

This symbol "O" means this option is possible

XX = Colour code to be indicated

For further information on colours, please see the page at the beginning of this section.

Further information on whirlpool systems please see page 585.

COLLARO Duo (Wall-facing, left-hand model 1800 x 800) Acrylic

€ excl. VAT

Included in scope of delivery: Matching outlet and overflow plus an installation set are supplied as standard.
Set of bath feet is supplied as standard (self-adhesive).

Technical information: Panel in the same colour as the bath
Whirlpool systems available on request.
Note: central positioning of the tap fitting is not possible.

Matching sanitary ceramics: Collaro
Matching furniture programme: Collaro

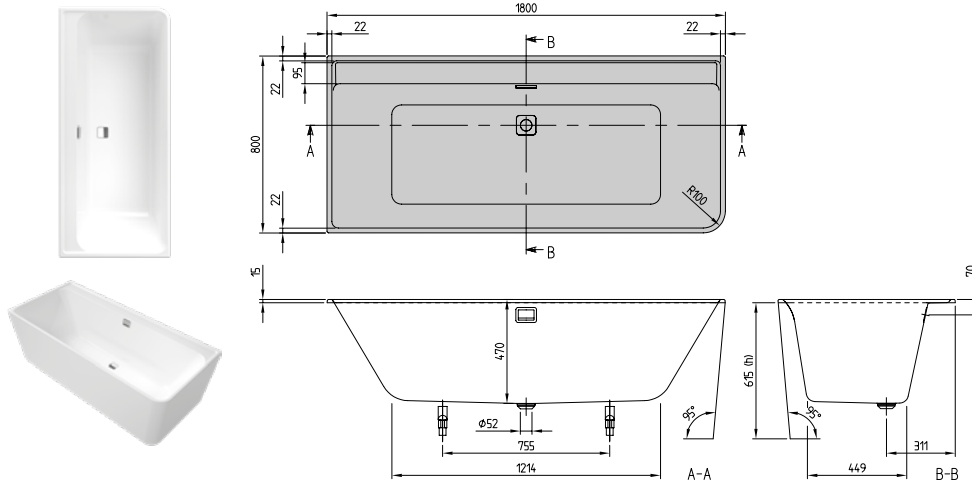

h = Installation height (min - max)	
Bath	615
Bath with panel	615

Article number	Description	Size l x w	Bottom l x w	Depth	Litres incl. 1 pers	Weight (kg)	01	pcs/pal.
UBA 180 COR 9CL00VD XX	Collaro, wall-facing, corner version left, Chrome	1800 x 800	1214 x 449	470	218	43		1
UBA 180 COR 9CL00VE XX	Collaro, wall-facing, corner version left, Champagne							1
UBA 180 COR 9CL00VJ XX	Collaro, wall-facing, corner version left, Gold							1
UBA 180 COR 9CL00VN XX	Collaro, wall-facing, corner version left, Black Matt							1

Accessories for baths:

Article number	Description	Price
UCCON0475	Pipe interruptor, incl. connections	
UPCON0137	Water inlet, plastic, integrated in the overflow, maximum water flow rate: 20 l/min	
U906100XX	Multifunction cushion, foam, 240 x 150 x 50 mm	

XX = Colour code to be indicated
For further information on colours, please see the page at the beginning of this section.
Further information on whirlpool systems please see page 585.

COLLARO Duo (Wall-facing, left-hand model 1800 x 800) Acrylic, Colour on Demand

€ excl. VAT

Included in scope of delivery: Matching outlet and overflow plus an installation set are supplied as standard.
Set of bath feet is supplied as standard (self-adhesive).

Technical information: **Whirlpool systems available on request.**
Note: central positioning of the tap fitting is not possible.

Matching sanitary ceramics: Collaro

Matching furniture programme: Collaro

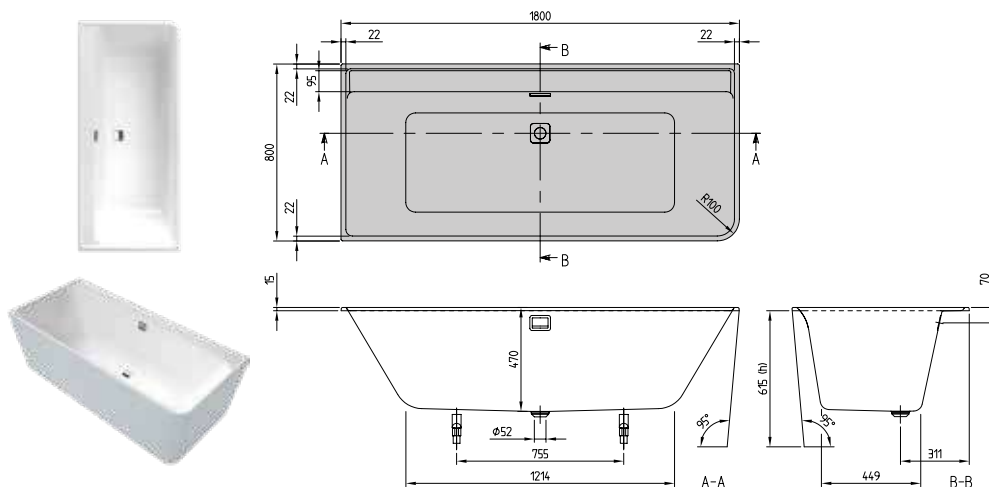

h = Installation height (min - max)	
Bath	615
Bath with panel	615

Article number	Description	Size l x w	Bottom l x w	Depth	Litres incl. 1 pers	Weight (kg)	01	pcs/pal.
UBA 180 COR 9CLBCVD XX	Collaro, wall-facing, corner version left, Chrome	1800 x 800	1214 x 449	470	218	43		1
UBA 180 COR 9CLBCVE XX	Collaro, wall-facing, corner version left, Champagne							1
UBA 180 COR 9CLBCVJ XX	Collaro, wall-facing, corner version left, Gold							1
UBA 180 COR 9CLBCVN XX	Collaro, wall-facing, corner version left, Black Matt							1

Accessories for baths:

Article number	Description	Price
UCCON0475	Pipe interruptor, incl. connections	
UPCON0137	Water inlet, plastic, integrated in the overflow, maximum water flow rate: 20 l/min	
U906100XX	Multifunction cushion, foam, 240 x 150 x 50 mm	

Made-to-order production - Colour on Demand: 3 week delivery period. Please make sure to use the **order form** that you will find immediately after the chapter on baths on page 578-579, so that we can complete the order for you.

XX = Colour code to be indicated
For further information on colours, please see the page at the beginning of this section.
Further information on whirlpool systems please see page 585.

COLLARO Duo (Wall-facing, right-hand model 1800 x 800) Acrylic

€ excl. VAT

Included in scope of delivery: Matching outlet and overflow plus an installation set are supplied as standard.
Set of bath feet is supplied as standard (self-adhesive).

Technical information: Panel in the same colour as the bath
Note: central positioning of the tap fitting is not possible.
Whirlpool systems available on request.

Matching sanitary ceramics: Collaro
Matching furniture programme: Collaro

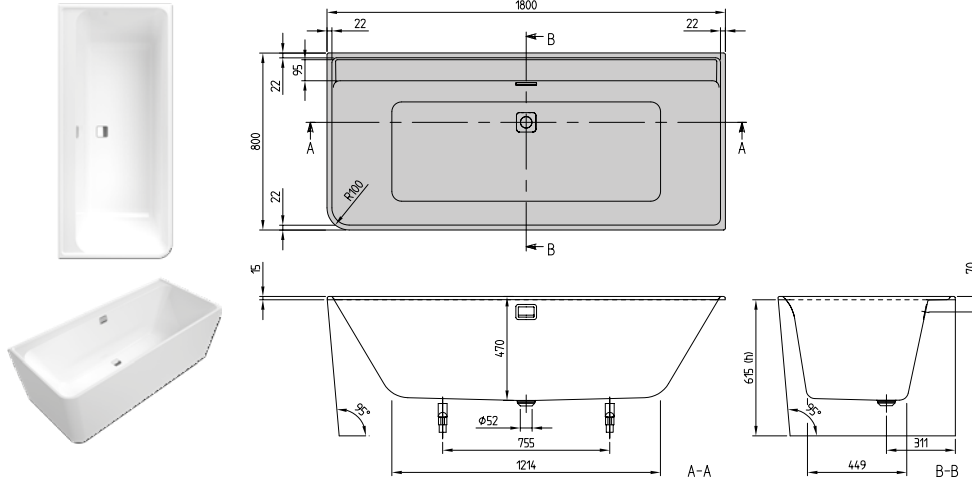

h = Installation height (min - max)	
Bath	615
Bath with panel	615

Article number	Description	Size l x w	Bottom l x w	Depth	Litres incl. 1 pers	Weight (kg)	01	pcs/pal.
UBA 180 COR 9CR00VD XX	Collaro, wall-facing, corner version right, Chrome	1800 x 800	1214 x 449	470	218	43		1
UBA 180 COR 9CR00VE XX	Collaro, wall-facing, corner version right, Champagne							1
UBA 180 COR 9CR00VJ XX	Collaro, wall-facing, corner version right, Gold							1
UBA 180 COR 9CR00VN XX	Collaro, wall-facing, corner version right, Black Matt							1

Accessories for baths:

Article number	Description	Price
UCCON0475	Pipe interruptor, incl. connections	
UPCON0137	Water inlet, plastic, integrated in the overflow, maximum water flow rate: 20 l/min	
U906100XX	Multifunction cushion, foam, 240 x 150 x 50 mm	

XX = Colour code to be indicated
For further information on colours, please see the page at the beginning of this section.
Further information on whirlpool systems please see page 585.

COLLARO Duo (Wall-facing, right-hand model 1800 x 800) Acrylic, Colour on Demand

€ excl. VAT

Included in scope of delivery: Matching outlet and overflow plus an installation set are supplied as standard.
Set of bath feet is supplied as standard (self-adhesive).

Technical information: **Whirlpool systems available on request.**
Note: central positioning of the tap fitting is not possible.

Matching sanitary ceramics: Collaro

Matching furniture programme: Collaro

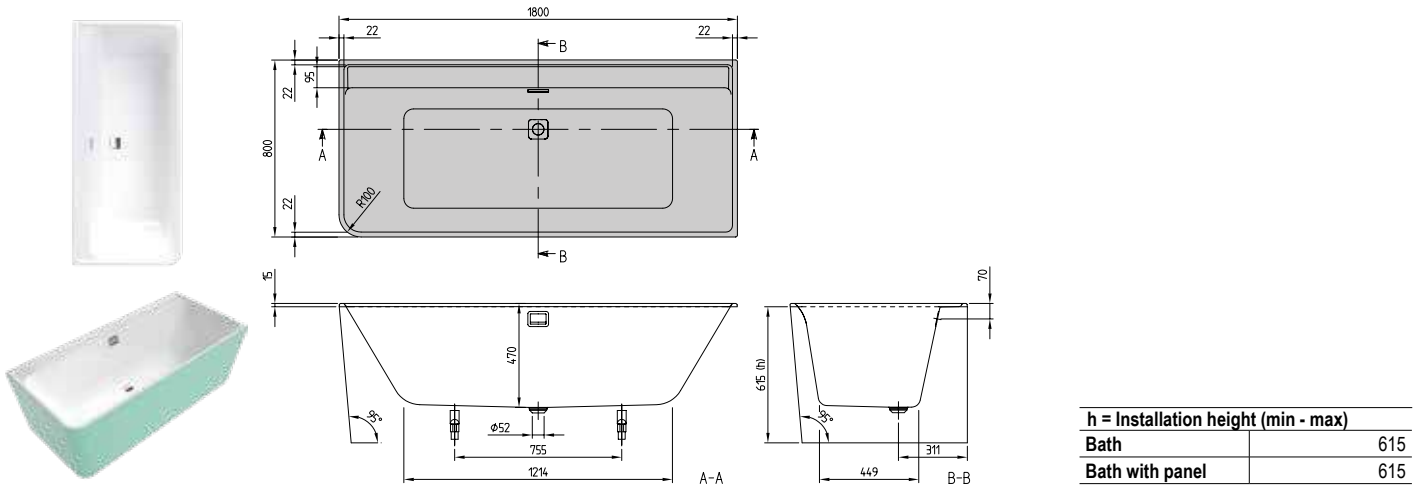

h = Installation height (min - max)	
Bath	615
Bath with panel	615

Article number	Description	Size l x w	Bottom l x w	Depth	Litres incl. 1 pers	Weight (kg)	01	pcs/pal.
UBA 180 COR 9CRBCVD XX	Collaro, wall-facing, corner version right, Colour on Demand, Chrome	1800 x 800	1214 x 449	470	218	43		1
UBA 180 COR 9CRBCVE XX	Collaro, wall-facing, corner version right, Colour on Demand, Champagne							1
UBA 180 COR 9CRBCVJ XX	Collaro, wall-facing, corner version right, Colour on Demand, Gold							1
UBA 180 COR 9CRBCVN XX	Collaro, wall-facing, corner version right, Colour on Demand, Black Matt							1

Accessories for baths:

Article number	Description	Price
UCCON0475	Pipe interruptor, incl. connections	
UPCON0137	Water inlet, plastic, integrated in the overflow, maximum water flow rate: 20 l/min	
U906100XX	Multifunction cushion, foam, 240 x 150 x 50 mm	

Made-to-order production - Colour on Demand: 3 week delivery period. Please make sure to use the **order form** that you will find immediately after the chapter on baths on page 578-579, so that we can complete the order for you.

XX = Colour code to be indicated
For further information on colours, please see the page at the beginning of this section.
Further information on whirlpool systems please see page 585.

COLLARO Duo (Wall-facing 1800 x 800) Acrylic

€ excl. VAT

Included in scope of delivery: Matching outlet and overflow plus an installation set are supplied as standard.
Set of bath feet is supplied as standard (self-adhesive).

Technical information: **Whirlpool systems available on request.**
Panel in the same colour as the bath
Note: central positioning of the tap fitting is not possible.

Matching sanitary ceramics: Collaro
Matching furniture programme: Collaro

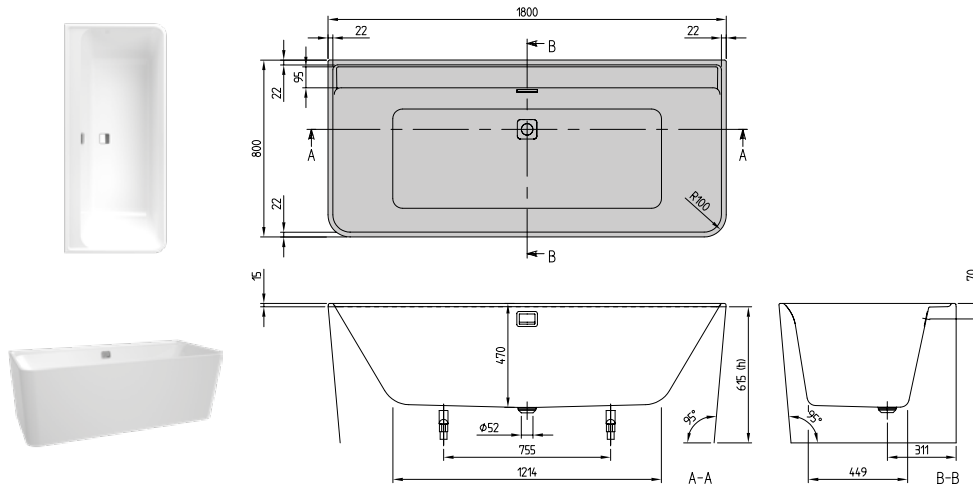

h = Installation height (min - max)	
Bath	615
Bath with panel	615

Article number	Description	Size l x w	Bottom l x w	Depth	Litres incl. 1 pers	Weight (kg)	01	pcs/pal.
UBA 180 COR 9CS00VD XX	Collaro, wall-facing, seamless, Chrome	1800 x 800	1214 x 449	470	218	43		1
UBA 180 COR 9CS00VE XX	Collaro, wall-facing, seamless, Champagne							1
UBA 180 COR 9CS00VJ XX	Collaro, wall-facing, seamless, Gold							1
UBA 180 COR 9CS00VN XX	Collaro, wall-facing, seamless, Black Matt							1

Accessories for baths:

Article number	Description	Price
UCCON0475	Pipe interruptor, incl. connections	
UPCON0137	Water inlet, plastic, integrated in the overflow, maximum water flow rate: 20 l/min	
U906100XX	Multifunction cushion, foam, 240 x 150 x 50 mm	

XX = Colour code to be indicated
For further information on colours, please see the page at the beginning of this section.
Further information on whirlpool systems please see page 585.

BATHS

COLLARO Duo (Wall-facing 1800 x 800) Acrylic, Colour on Demand

€ excl. VAT

Included in scope of delivery: Matching outlet and overflow plus an installation set are supplied as standard.
Set of bath feet is supplied as standard (self-adhesive).

Technical information: **Whirlpool systems available on request.**
Note: central positioning of the tap fitting is not possible.

Matching sanitary ceramics: Collaro

Matching furniture programme: Collaro

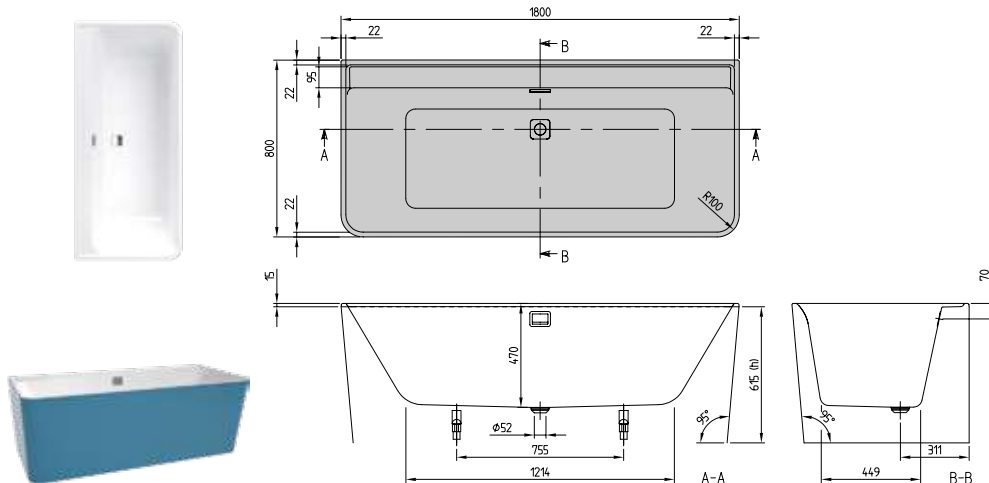

h = Installation height (min - max)	
Bath	615
Bath with panel	615

Article number	Description	Size l x w	Bottom l x w	Depth	Litres incl. 1 pers	Weight (kg)	01	pcs/pal.
UBA 180 COR 9CSBCVD XX	Collaro, wall-facing, Colour on Demand, seamless, Chrome	1800 x 800	1214 x 449	470	218	43		1
UBA 180 COR 9CSBCVE XX	Collaro, wall-facing, Colour on Demand, seamless, Champagne							1
UBA 180 COR 9CSBCVJ XX	Collaro, wall-facing, Colour on Demand, seamless, Gold							1
UBA 180 COR 9CSBCVN XX	Collaro, wall-facing, Colour on Demand, seamless, Black Matt							1

Accessories for baths:

Article number	Description	Price
UCCON0475	Pipe interruptor, incl. connections	
UPCON0137	Water inlet, plastic, integrated in the overflow, maximum water flow rate: 20 l/min	
U906100XX	Multifunction cushion, foam, 240 x 150 x 50 mm	

Made-to-order production - Colour on Demand: 3 week delivery period. Please make sure to use the **order form** that you will find immediately after the chapter on baths on page 578-579, so that we can complete the order for you.

XX = Colour code to be indicated
For further information on colours, please see the page at the beginning of this section.
Further information on whirlpool systems please see page 585.

FINION BATH



€ excl. VAT

Free-standing Quaryl® bath with optional design ring and Emotion feature (LED lighting)



- Dimensions: 170 x 70 cm
- A compact bath that is uniquely spacious (comparable with a conventional bath measuring 180 x 80 cm)
- Also ideal for smaller bathrooms
- Delicate design thanks to innovative monolith technology
- Extremely thin and precise edges with a thickness of just 15 mm
- Colour on Demand option

BATHS

Individual combination possibilities



Push-to-Open valve and flush-fit, integrated overflow (included as standard in the scope of delivery in the selected colour Chrome, Gold or Champagne)



Flush-fit, integrated water inlet in the colour of the Push-to-Open valve and overflow optionally available (Position opposite overflow)



Optional **design ring** & optional **Emotion feature** (LED lighting) are already preassembled – both are also available separately

Metal colours



Gold



Champagne



Chrome

Colour on Demand option



Order form p. 578-579

FINION BATH



€ excl. VAT

Details about LED lighting

Lighting	LED / 12 Volt, max. 30 W, IPX5
Energy efficiency class	A - A++
Light colour in Kelvin	2700 K (warm white) to 6500 K (cold white)
Power supply unit	230 volt, 50 Hz, 30 W, IPX5, protection rating II

This is how to order a Finion bath

The article number for a Finion bath consists of the following:

UBQ 177 FIN 7 _ _ ZZ V Y XX

Please note that for reasons of space, the hyphen before the colour number "XX" is replaced by a different number "Y". Depending on the option, this means that the "V" is followed directly by 101, 201, 301 or 401.

Step 1: Please replace _ _ in the article number with the colour of the Push-to-Open valve, the overflow and (if desired) the factory-fitted water inlet:

- A1 = Push-to-Open valve and overflow in Chrome
- A2 = Push-to-Open valve and overflow in Champagne
- A3 = Push-to-Open valve and overflow in Gold
- N1 = Push-to-Open valve, overflow and factory-fitted water inlet in Chrome
- N2 = Push-to-Open valve, overflow and factory-fitted water inlet in Champagne
- N3 = Push-to-Open valve, overflow and factory-fitted water inlet in Gold

Step 2: Please replace ZZ in the article number with the colour option:

- BC = With Bicolour option (see order form with Colour on Demand on page 578-579)
- 00 = Without Bicolour option

Step 3: Please replace Y in the article number with the option for design ring* and Emotion feature:**

- 1 = With design ring, with Emotion feature
- 2 = With design ring, without Emotion feature
- 3 = Without Design ring, with Emotion feature
- 4 = Without design ring, without Emotion feature

* The design ring is always supplied in the same colour as the Push-to-Open valve and the overflow

** An additional remote control (article number G9990200 – not included in scope of delivery) is required to operate the bath's Emotion feature. The remote control can be used for the bath lighting and furniture lighting. Please note: Be careful not to order this twice!

Step 4: Please replace XX in the article number with the colour of the inside of the bath:

- 01 = White Alpin
- RW = Stone White

Example:

Article number	Description
UBQ 177 FIN 7A1BCV1 XX	Finion, free-standing, seamless, Colour on Demand (Quaryl®), including factory-fitted push-to-open valve and overflow, Design ring and Emotion feature, chrome

FINION Duo (Free-standing 1700 x 700) Quarryl®, Furnishings Chrome

€ excl. VAT

Included in scope of delivery:
Not included in scope of delivery:
Technical information:

The push-to-Open valve and overflow are supplied as standard (pre-mounted).
 Remote control for the Emotion feature
 Furnishings in Chrome. The remote control can be used for the bath lighting, furniture lighting and mirror lighting. **Please note: Be careful not to order this twice!**
 Additional technical drawings with LED lighting and design ring are available at any time from our professional portal at pro.villeroy-boch.com.
Matching sanitary ceramics: Finion
Matching furniture programme: Finion

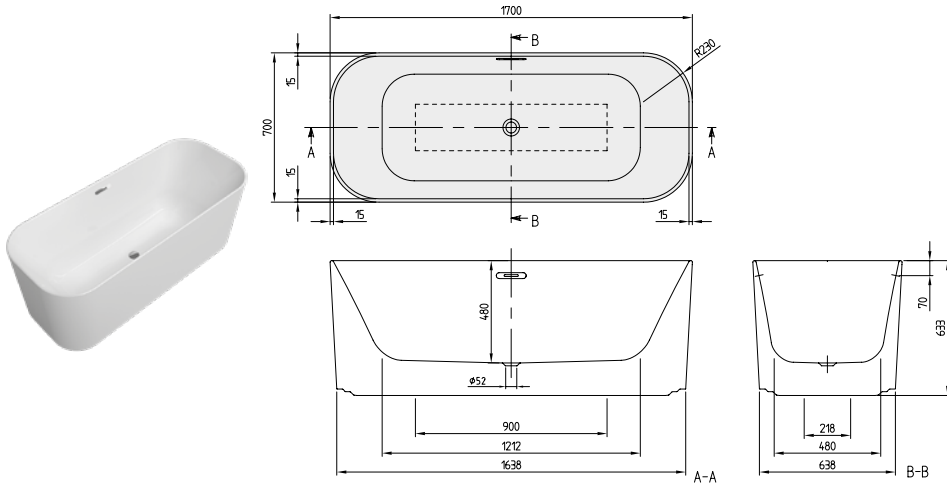

h = Installation height (min - max)	
Bath	633 - 633

Article number	Description	Size l x w	Bottom l x w	Depth	Litres incl. 1 pers	Weight (kg)	01	RW	pcs/pat.
UBQ 177 FIN 7A100V4 XX	Finion, freestanding, seamless, incl. factory-fitted Push-to-Open valve and overflow, Chrome	1700 x 700	1212 x 480	480	221	104,4			1
UBQ 177 FIN 7N100V4 XX	Finion, freestanding, seamless, incl. factory-fitted Push-to-Open valve, overflow and water inlet, Chrome								1
UBQ 177 FIN 7A100V2 XX	Finion, freestanding, seamless, incl. factory-fitted Push-to-Open valve and overflow, design ring, Chrome					104,9			1
UBQ 177 FIN 7N100V2 XX	Finion, freestanding, seamless, incl. factory-fitted Push-to-Open valve, overflow and water inlet, design ring, Chrome								1
UBQ 177 FIN 7A100V3 XX	Finion, freestanding, seamless, incl. factory-fitted Push-to-Open valve and overflow, Emotion feature, Chrome					105,9			1
UBQ 177 FIN 7N100V3 XX	Finion, freestanding, seamless, incl. factory-fitted Push-to-Open valve, overflow and water inlet, Emotion feature, Chrome								1
UBQ 177 FIN 7A100V1 XX	Finion, freestanding, seamless, incl. factory-fitted Push-to-Open valve and overflow, design ring and Emotion feature, Chrome					106,4			1
UBQ 177 FIN 7N100V1 XX	Finion, freestanding, seamless, incl. factory-fitted Push-to-Open valve, overflow and water inlet, design ring and Emotion feature, Chrome								1

Accessories for baths:

Article number	Description	Price
UCCON0475	Pipe interruptor, incl. connections	
G999 02 00	Remote control, including mount	

XX = Colour code to be indicated
 For further information on colours, please see the page at the beginning of this section.
 Further information on whirlpool systems please see page 585.

FINION Duo (Free-standing 1700 x 700) Quarry[®], Furnishings Champagne

€ excl. VAT

Included in scope of delivery:
Not included in scope of delivery:
Technical information:

The push-to-Open valve and overflow are supplied as standard (pre-mounted).
 Remote control for the Emotion feature
 Furnishings in Champagne. The remote control can be used for the bath lighting, furniture lighting and mirror lighting. **Please note: Be careful not to order this twice!**
 Additional technical drawings with LED lighting and design ring are available at any time from our professional portal at pro.villeroy-boch.com.
Matching sanitary ceramics: Finion
Matching furniture programme: Finion

BATHS

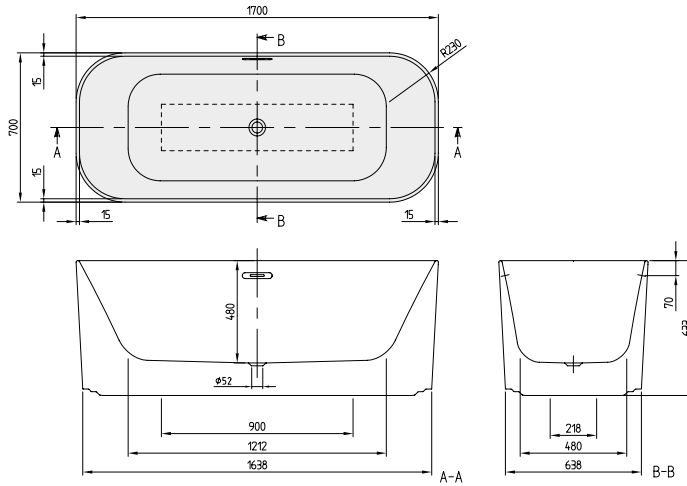

h = Installation height (min - max)	
Bath	633 - 633

Article number	Description	Size l x w	Bottom l x w	Depth	Litres incl. 1 pers	Weight (kg)	01	RW	pcs/pat.
UBQ 177 FIN 7A200V4 XX	Finion, freestanding, seamless, incl. factory-fitted Push-to-Open valve and overflow, Champagne	1700 x 700	1212 x 480	480	221	104,4			1
UBQ 177 FIN 7N200V4 XX	Finion, freestanding, seamless, incl. factory-fitted Push-to-Open valve, overflow and water inlet, Champagne								1
UBQ 177 FIN 7A200V2 XX	Finion, freestanding, seamless, incl. factory-fitted Push-to-Open valve and overflow, design ring, Champagne					104,9			1
UBQ 177 FIN 7N200V2 XX	Finion, freestanding, seamless, incl. factory-fitted Push-to-Open valve, overflow and water inlet, design ring, Champagne								1
UBQ 177 FIN 7A200V3 XX	Finion, freestanding, seamless, incl. factory-fitted Push-to-Open valve and overflow, Emotion feature, Champagne					105,9			1
UBQ 177 FIN 7N200V3 XX	Finion, freestanding, seamless, incl. factory-fitted Push-to-Open valve, overflow and water inlet, Emotion feature, Champagne								1
UBQ 177 FIN 7A200V1 XX	Finion, freestanding, seamless, incl. factory-fitted Push-to-Open valve and overflow, design ring and Emotion feature, Champagne					106,4			1
UBQ 177 FIN 7N200V1 XX	Finion, freestanding, seamless, incl. factory-fitted Push-to-Open valve, overflow and water inlet, design ring and Emotion feature, Champagne								1

Accessories for baths:

Article number	Description	Price
UCCON0475	Pipe interruptor, incl. connections	
G999 02 00	Remote control, including mount	

XX = Colour code to be indicated
 For further information on colours, please see the page at the beginning of this section.
 Further information on whirlpool systems please see page 585.

FINION Duo (Free-standing 1700 x 700) Quarry^l, Furnishings Gold

€ excl. VAT

Included in scope of delivery:
Not included in scope of delivery:
Technical information:

The push-to-Open valve and overflow are supplied as standard (pre-mounted).
 Remote control for the Emotion feature
 Furnishings in Gold. The remote control can be used for the bath lighting, furniture lighting and mirror lighting. **Please note: Be careful not to order this twice!**
 Additional technical drawings with LED lighting and design ring are available at any time from our professional portal at pro.villeroy-boch.com.
Matching sanitary ceramics: Finion
Matching furniture programme: Finion

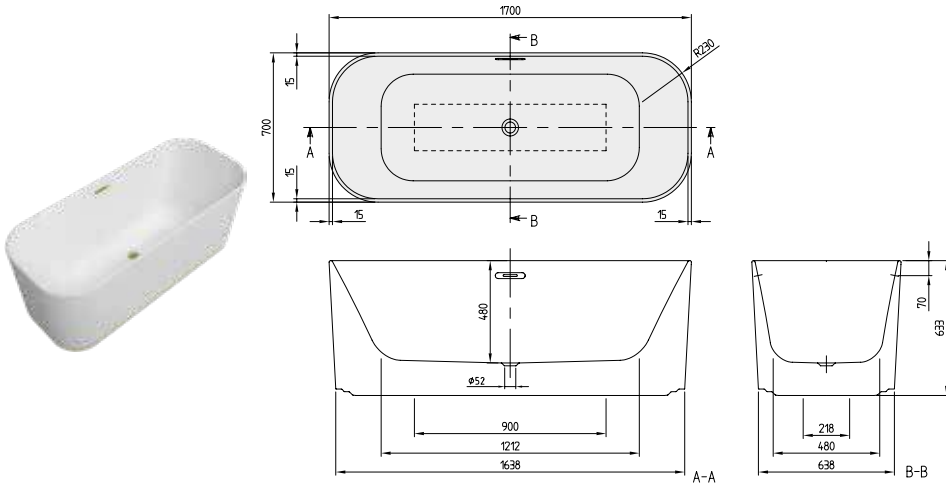

Quarry^l

BATHS

h = Installation height (min - max)	
Bath	633 - 633

Article number	Description	Size l x w	Bottom l x w	Depth	Litres incl. 1 pers	Weight (kg)	01	RW	pcs/pat.
UBQ 177 FIN 7A300V4 XX	Finion, freestanding, seamless, incl. factory-fitted Push-to-Open valve and overflow, Gold	1700 x 700	1212 x 480	480	221	104,4			1
UBQ 177 FIN 7N300V4 XX	Finion, freestanding, seamless, incl. factory-fitted Push-to-Open valve, overflow and water inlet, Gold							1	
UBQ 177 FIN 7A300V2 XX	Finion, freestanding, seamless, incl. factory-fitted Push-to-Open valve and overflow, design ring, Gold					104,9		1	
UBQ 177 FIN 7N300V2 XX	Finion, freestanding, seamless, incl. factory-fitted Push-to-Open valve, overflow and water inlet, design ring, Gold							1	
UBQ 177 FIN 7A300V3 XX	Finion, freestanding, seamless, incl. factory-fitted Push-to-Open valve and overflow, Emotion feature, Gold					105,9		1	
UBQ 177 FIN 7N300V3 XX	Finion, freestanding, seamless, incl. factory-fitted Push-to-Open valve, overflow and water inlet, Emotion feature, Gold							1	
UBQ 177 FIN 7A300V1 XX	Finion, freestanding, seamless, incl. factory-fitted Push-to-Open valve and overflow, design ring and Emotion feature, Gold					106,4		1	
UBQ 177 FIN 7N300V1 XX	Finion, freestanding, seamless, incl. factory-fitted Push-to-Open valve, overflow and water inlet, design ring and Emotion feature, Gold							1	

Accessories for baths:

Article number	Description	Price
UCCON0475	Pipe interruptor, incl. connections	
G999 02 00	Remote control, including mount	

XX = Colour code to be indicated
 For further information on colours, please see the page at the beginning of this section.
 Further information on whirlpool systems please see page 585.

FINION Duo (Free-standing 1700 x 700) Quarry[®], Furnishings Chrome, Colour on Demand

€ excl. VAT

Included in scope of delivery:
Not included in scope of delivery:
Technical information:

The push-to-Open valve and overflow are supplied as standard (pre-mounted).
 Remote control for the Emotion feature
 Furnishings in Chrome. The remote control can be used for the bath lighting, furniture lighting and mirror lighting. **Please note: Be careful not to order this twice!**
 Additional technical drawings with LED lighting and design ring are available at any time from our professional portal at pro.villeroy-boch.com.
Matching sanitary ceramics: Finion
Matching furniture programme: Finion

BATHS

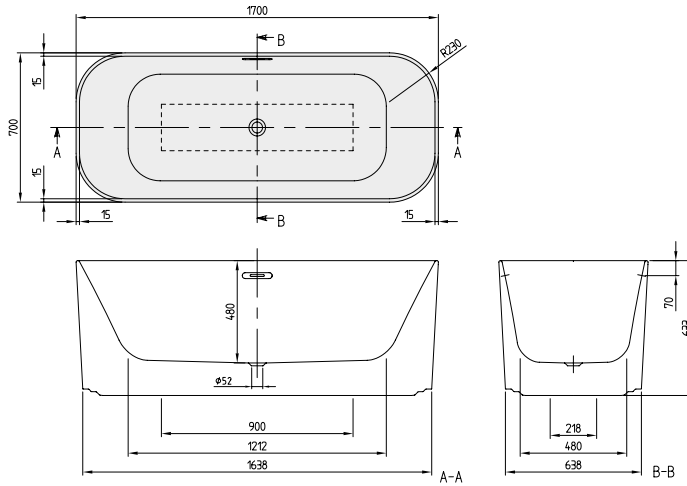

Quarry[®]

Article number	Description	Size l x w	Bottom l x w	Depth	Litres incl. 1 pers	Weight (kg)	01	RW	pcs/pal.
UBQ 177 FIN 7A1BCV4 XX	Finion, freestanding, seamless, Colour on Demand (Quarry [®]), incl. factory-fitted Push-to-Open valve and overflow, Chrome	1700 x 700	1212 x 480	480	221	104,4			1
UBQ 177 FIN 7N1BCV4 XX	Finion, freestanding, seamless, Colour on Demand (Quarry [®]), incl. factory-fitted Push-to-Open valve, overflow and water inlet, Chrome								1
UBQ 177 FIN 7A1BCV2 XX	Finion, freestanding, seamless, Colour on Demand (Quarry [®]), incl. factory-fitted Push-to-Open valve and overflow, design ring, Chrome					104,9			1
UBQ 177 FIN 7N1BCV2 XX	Finion, freestanding, seamless, Colour on Demand (Quarry [®]), incl. factory-fitted Push-to-Open valve, overflow and water inlet, design ring, Chrome								1
UBQ 177 FIN 7A1BCV3 XX	Finion, freestanding, seamless, Colour on Demand (Quarry [®]), incl. factory-fitted Push-to-Open valve and overflow, Emotion feature, Chrome					105,9			1
UBQ 177 FIN 7N1BCV3 XX	Finion, freestanding, seamless, Colour on Demand (Quarry [®]), incl. factory-fitted Push-to-Open valve, overflow and water inlet, Emotion feature, Chrome								1
UBQ 177 FIN 7A1BCV1 XX	Finion, freestanding, seamless, Colour on Demand (Quarry [®]), incl. factory-fitted Push-to-Open valve and overflow, design ring and Emotion feature, Chrome					106,4			1
UBQ 177 FIN 7N1BCV1 XX	Finion, freestanding, seamless, Colour on Demand (Quarry [®]), incl. factory-fitted Push-to-Open valve, overflow and water inlet, design ring and Emotion feature, Chrome								1

Accessories for baths:

Article number	Description	Price
UCCON0475	Pipe interruptor, incl. connections	
G999 02 00	Remote control, including mount	

Made-to-order production - Colour on Demand: 3 week delivery period. Please make sure to use the **order form** that you will find immediately after the chapter on baths on page 578-579, so that we can complete the order for you.

XX = Colour code to be indicated
 For further information on colours, please see the page at the beginning of this section.
 Further information on whirlpool systems please see page 585.

FINION Duo (Free-standing 1700 x 700) Quarry[®], Furnishings Champagne, Colour on Demand

€ excl. VAT

Included in scope of delivery:
Not included in scope of delivery:
Technical information:

The push-to-Open valve and overflow are supplied as standard (pre-mounted).
 Remote control for the Emotion feature
 Furnishings in Champagne. The remote control can be used for the bath lighting, furniture lighting and mirror lighting. **Please note: Be careful not to order this twice!**
 Additional technical drawings with LED lighting and design ring are available at any time from our professional portal at pro.villeroy-boch.com.
Matching sanitary ceramics: Finion
Matching furniture programme: Finion

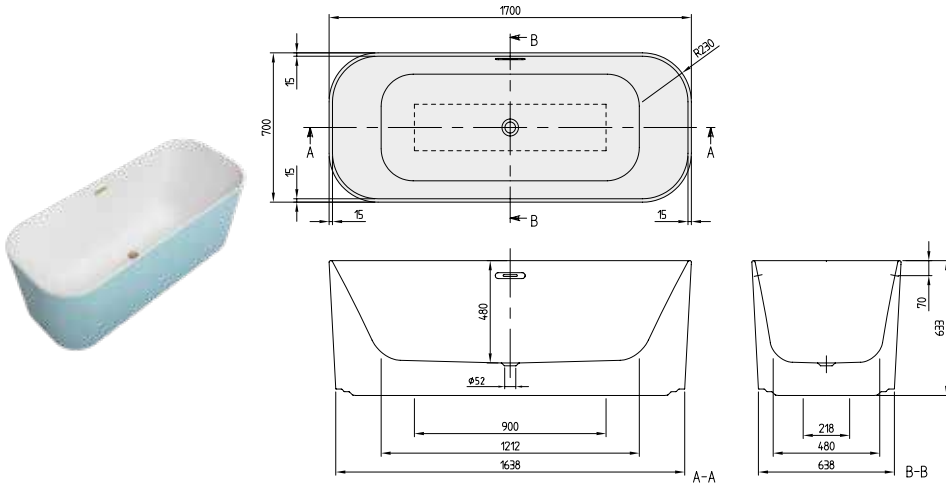

BATHS

Article number	Description	Size l x w	Bottom l x w	Depth	Litres incl. 1 pers	Weight (kg)	01	RW	pcs/pal.
UBQ 177 FIN 7A2BCV4 XX	Finion, freestanding, seamless, Colour on Demand (Quarry [®]), incl. factory-fitted Push-to-Open valve and overflow, Champagne	1700 x 700	1212 x 480	480	221	104,4			1
UBQ 177 FIN 7N2BCV4 XX	Finion, freestanding, seamless, Colour on Demand (Quarry [®]), incl. factory-fitted Push-to-Open valve, overflow and water inlet, Champagne								1
UBQ 177 FIN 7A2BCV2 XX	Finion, freestanding, seamless, Colour on Demand (Quarry [®]), incl. factory-fitted Push-to-Open valve and overflow, design ring, Champagne					104,9			1
UBQ 177 FIN 7N2BCV2 XX	Finion, freestanding, seamless, Colour on Demand (Quarry [®]), incl. factory-fitted Push-to-Open valve, overflow and water inlet, design ring, Champagne								1
UBQ 177 FIN 7A2BCV3 XX	Finion, freestanding, seamless, Colour on Demand (Quarry [®]), incl. factory-fitted Push-to-Open valve and overflow, Emotion feature, Champagne					105,9			1
UBQ 177 FIN 7N2BCV3 XX	Finion, freestanding, seamless, Colour on Demand (Quarry [®]), incl. factory-fitted Push-to-Open valve, overflow and water inlet, Emotion feature, Champagne								1
UBQ 177 FIN 7A2BCV1 XX	Finion, freestanding, seamless, Colour on Demand (Quarry [®]), incl. factory-fitted Push-to-Open valve and overflow, design ring and Emotion feature, Champagne					106,4			1
UBQ 177 FIN 7N2BCV1 XX	Finion, freestanding, seamless, Colour on Demand (Quarry [®]), incl. factory-fitted Push-to-Open valve, overflow and water inlet, design ring and Emotion feature, Champagne								1

Accessories for baths:

Article number	Description	Price
UCCON0475	Pipe interruptor, incl. connections	
G999 02 00	Remote control, including mount	

Made-to-order production - Colour on Demand: 3 week delivery period. Please make sure to use the **order form** that you will find immediately after the chapter on baths on page 578-579, so that we can complete the order for you.

XX = Colour code to be indicated
 For further information on colours, please see the page at the beginning of this section.
 Further information on whirlpool systems please see page 585.

FINION Duo (Free-standing 1700 x 700) Quarry[®], Furnishings Gold, Colour on Demand

€ excl. VAT

Included in scope of delivery:

The push-to-Open valve and overflow are supplied as standard (pre-mounted).

Not included in scope of delivery:

Remote control for the Emotion feature

Technical information:

Furnishings in Gold. The remote control can be used for the bath lighting, furniture lighting and mirror lighting. **Please note: Be careful not to order this twice!**

Additional technical drawings with LED lighting and design ring are available at any time from our professional portal at pro.villeroy-boch.com.

Matching sanitary ceramics:

Finion

Matching furniture programme:

Finion

BATHS

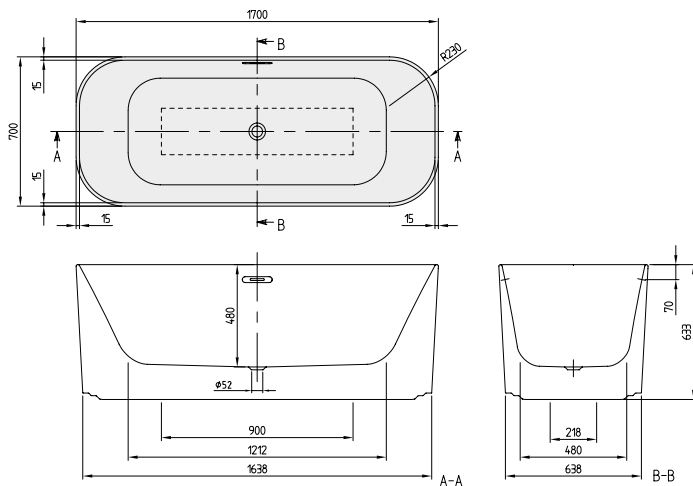

Quarry[®]

Article number	Description	Size l x w	Bottom l x w	Depth	Litres incl. 1 pers	Weight (kg)	01	RW	pcs/pal.
UBQ 177 FIN 7A3BCV4 XX	Finion, freestanding, seamless, Colour on Demand (Quarry [®]), incl. factory-fitted Push-to-Open valve and overflow, Gold	1700 x 700	1212 x 480	480	221	104,4			1
UBQ 177 FIN 7N3BCV4 XX	Finion, freestanding, seamless, Colour on Demand (Quarry [®]), incl. factory-fitted Push-to-Open valve, overflow and water inlet, Gold								1
UBQ 177 FIN 7A3BCV2 XX	Finion, freestanding, seamless, Colour on Demand (Quarry [®]), incl. factory-fitted Push-to-Open valve and overflow, design ring, Gold					104,9			1
UBQ 177 FIN 7N3BCV2 XX	Finion, freestanding, seamless, Colour on Demand (Quarry [®]), incl. factory-fitted Push-to-Open valve, overflow and water inlet, design ring, Gold								1
UBQ 177 FIN 7A3BCV3 XX	Finion, freestanding, seamless, Colour on Demand (Quarry [®]), incl. factory-fitted Push-to-Open valve and overflow, Emotion feature, Gold					105,9			1
UBQ 177 FIN 7N3BCV3 XX	Finion, freestanding, seamless, Colour on Demand (Quarry [®]), incl. factory-fitted Push-to-Open valve, overflow and water inlet, Emotion feature, Gold								1
UBQ 177 FIN 7A3BCV1 XX	Finion, freestanding, seamless, Colour on Demand (Quarry [®]), incl. factory-fitted Push-to-Open valve and overflow, design ring and Emotion feature, Gold					106,4			1
UBQ 177 FIN 7N3BCV1 XX	Finion, freestanding, seamless, Colour on Demand (Quarry [®]), incl. factory-fitted Push-to-Open valve, overflow and water inlet, design ring and Emotion feature, Gold								1

Accessories for baths:

Article number	Description	Price
UCCON0475	Pipe interruptor, incl. connections	
G999 02 00	Remote control, including mount	

Made-to-order production - Colour on Demand: 3 week delivery period. Please make sure to use the **order form** that you will find immediately after the chapter on baths on page 578-579, so that we can complete the order for you.

XX = Colour code to be indicated

For further information on colours, please see the page at the beginning of this section.

Further information on whirlpool systems please see page 585.

HOMMAGE Duo (Free-standing 1771 x 771) Quarry®

€ excl. VAT

Technical information: Outside surface in satin finish.
Matching sanitary ceramics: Hommage
Matching furniture programme: Hommage

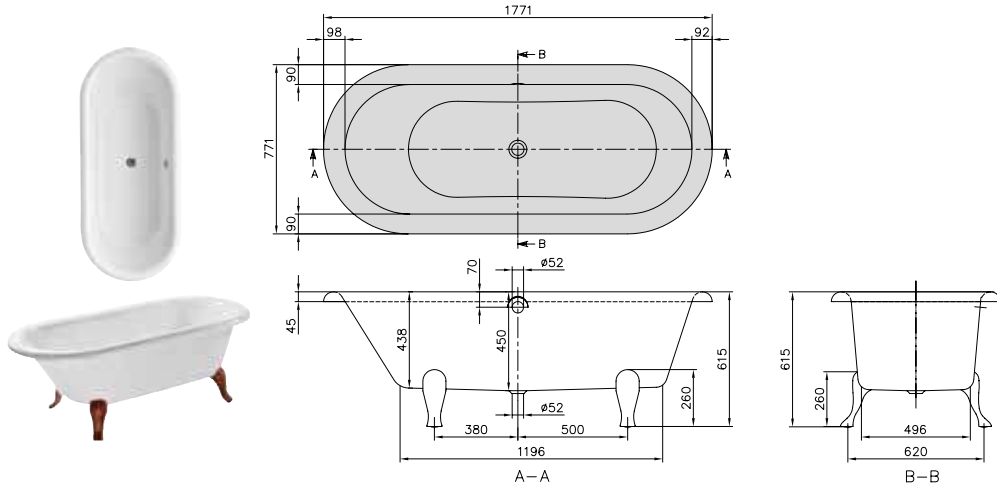

Article number	Description	Size l x w	Bottom l x w	Depth	Litres incl. 1 pers	Weight (kg)	01	pcs/pal.
UBQ 180 HOM 700V-XX	Hommage, incl. wooden feet	1771 x 771	1200 x 500	450	160	49,4		1
UBQ 180 HOM 7W0V-XX	Hommage, incl. feet (white)							1

Accessories for baths:

Article number	Description	Price
U99880061	Waste and overflow combination, with chain and plug type, chrome	
U99880062	Waste and overflow combination, with chain and plug type, Gold Plated	
U99880066	Waste and overflow combination, with chain and plug type, Noble Brass	
U906100XX	Multifunction cushion, foam, 240 x 150 x 50 mm	

XX = Colour code to be indicated
 For further information on colours, please see the page at the beginning of this section.
 Further information on whirlpool systems please see page 585.

LA BELLE Duo (Rectangle 1800 x 800) Quarryl®

€ excl. VAT

Included in scope of delivery:

Set of bath feet is supplied as standard (self-adhesive), adjustable from 130 à 180 mm.

Technical information:

Whirlpool systems available on request.

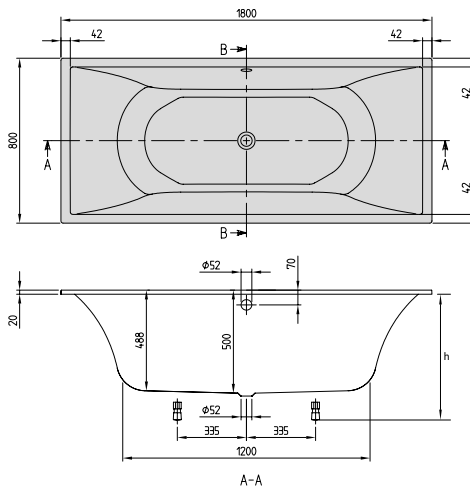

h = Installation height (min - max)	
Bath	640 - 690

Article number	Description	Size l x w	Bottom l x w	Depth	Litres incl. 1 pers	Weight (kg)	01	pcs/pal.
UBQ 180 LAB 2V-XX	La Belle, built-in version	1800 x 800	1200 x 483	500	200	48		8

Accessories for baths:

Article number	Description	Price
U90950461	Multiplex waste/overflow combination, chrome	
UCCON0475	Pipe interruptor, incl. connections	
U90600361	Multiplex Trio Outlet/overflow fitting with water inlet, chrome	
U90600461	Multiplex Trio Outlet/overflow fitting with water inlet and pipe interruptor, chrome	
U90170061	Handgrips, 1 pair = 2 grips, chrome	
U906100XX	Multifunction cushion, foam, 240 x 150 x 50 mm	

Preassembled bath options in combination with:

For order form, see fold-out page on the right-hand side

TouchLight

Price

XX = Colour code to be indicated
 For further information on colours, please see the page at the beginning of this section.
 Further information on whirlpool systems please see page 585.

LA BELLE Duo (Free-standing 1800 x 800) Quarryl®

€ excl. VAT

Included in scope of delivery:

Matching outlet and overflow (Chrome) is supplied as standard.

Technical information:

Bath and panel are of the material Quarryl® (2 parts). Panel is also the frame (Height of the panel: 620 mm).

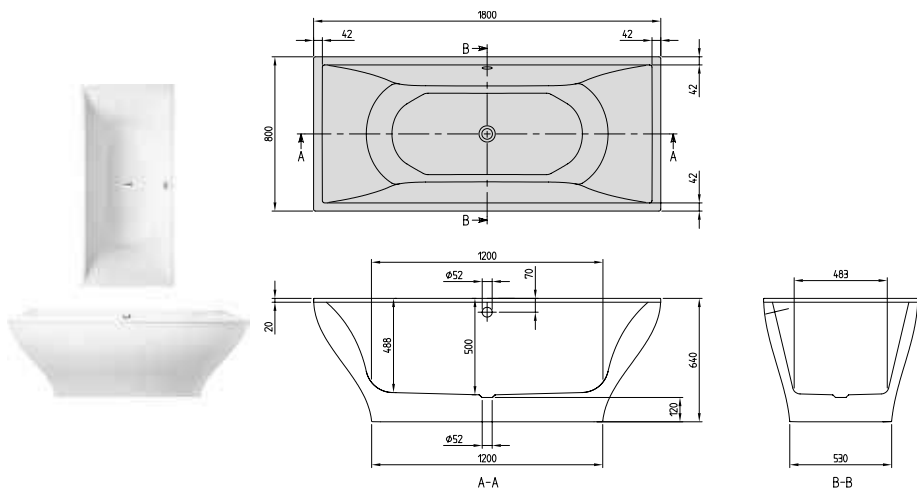

BATHS

Article number	Description	Size l x w	Bottom l x w	Depth	Litres incl. 1 pers	Weight (kg)	01	RW	pcs/pal.
UBQ 180 LAB 2PDV-XX	La Belle, freestanding, incl. Quarryl® panel in the same colour as the bath, incl. waste/overflow chrome-plated	1800 x 800	1200 x 483	500	200	103			1

Accessories for baths:

Article number	Description	Price
UCCON0475	Pipe interruptor, incl. connections	
U90600361	Multiplex Trio Outlet/overflow fitting with water inlet, chrome	
U90600461	Multiplex Trio Outlet/overflow fitting with water inlet and pipe interrupter, chrome	
U906100XX	Multifunction cushion, foam, 240 x 150 x 50 mm	

XX = Colour code to be indicated
 For further information on colours, please see the page at the beginning of this section.
 Further information on whirlpool systems please see page 585.

LA BELLE Duo (Free-standing 1800 x 800) Quarryl®, Colour on Demand

€ excl. VAT

Included in scope of delivery:

Matching outlet and overflow (Chrome) is supplied as standard.

Technical information:

Bath and panel are of the material Quarryl® (2 parts). Panel is also the frame (Height of the panel: 620 mm).

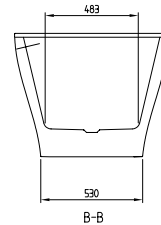
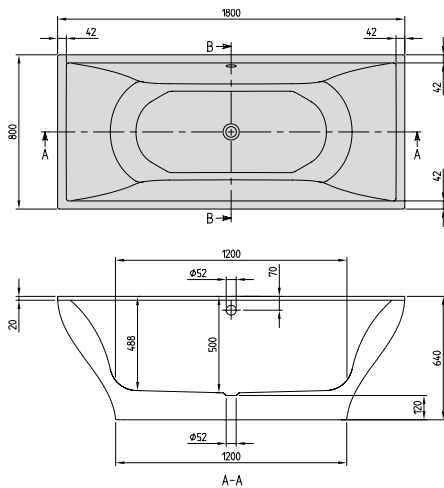

Article number	Description	Size l x w	Bottom l x w	Depth	Litres incl. 1 pers	Weight (kg)	01	RW	pcs/pal.
UBQ 180 LAB 2PDBCX-XX	La Belle, freestanding, incl. panel in Colour on Demand (Quarryl®), incl. waste/overflow chrome-plated	1800 x 800	1200 x 483	500	200	98,9			1

Accessories for baths:

Article number	Description	Price
U90600361	Multiplex Trio Outlet/overflow fitting with water inlet, chrome	
U90600461	Multiplex Trio Outlet/overflow fitting with water inlet and pipe interrupter, chrome	
U906100XX	Multifunction cushion, foam, 240 x 150 x 50 mm	

Made-to-order production - Colour on Demand: 3 week delivery period. Please make sure to use the **order form** that you will find immediately after the chapter on baths on page 578-579, so that we can complete the order for you.

XX = Colour code to be indicated
 For further information on colours, please see the page at the beginning of this section.
 Further information on whirlpool systems please see page 585.

LA BELLE Excellence Duo (Free-standing 1800 x 800) Quarryl®

€ excl. VAT

Included in scope of delivery: Matching outlet and overflow (Chrome) is supplied as standard.

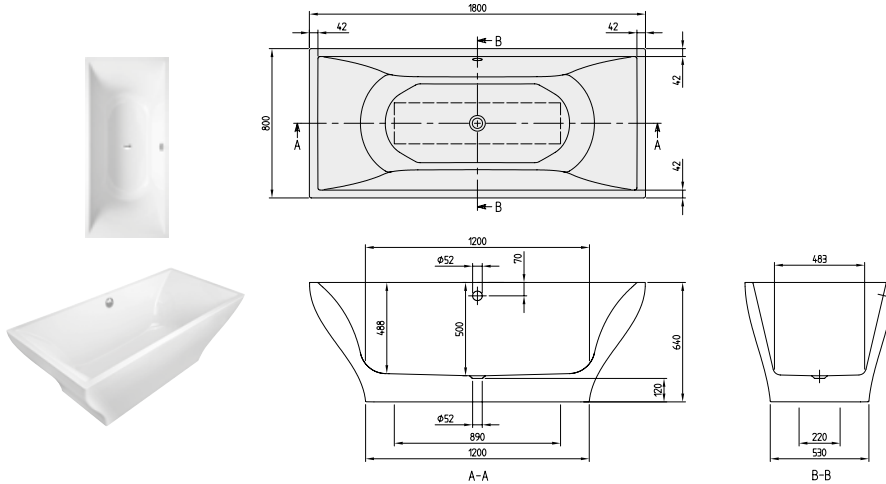

Article number	Description	Size l x w	Bottom l x w	Depth	Litres incl. 1 pers	Weight (kg)	01	RW	pcs/pal.
UBQ 180 LAB 9W1V-XX	La Belle, freestanding, seamless, incl. waste/overflow chrome-plated, Excellence	1800 x 800	1200 x 483	500	200	98,9			1
UBQ 180 LAB 9T1V-XX	La Belle, freestanding, seamless, incl. pre-fitted Multiplex Trio (chrome plated), Excellence								1

Accessories for baths:

Article number	Description	Price
UCCON0475	Pipe interruptor, incl. connections	
U906100XX	Multifunction cushion, foam, 240 x 150 x 50 mm	

XX = Colour code to be indicated
 For further information on colours, please see the page at the beginning of this section.
 Further information on whirlpool systems please see page 585.

BATHS

LA BELLE Excellence Duo (Free-standing 1800 x 800) Quarry[®], Colour on Demand

€ excl. VAT

Included in scope of delivery: Matching outlet and overflow (Chrome) is supplied as standard.

Quarry[®]

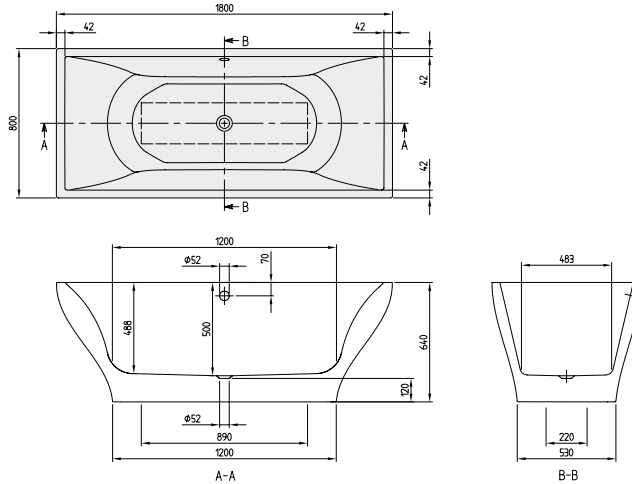

Article number	Description	Size l x w	Bottom l x w	Depth	Litres incl. 1 pers	Weight (kg)	01	RW	pcs/pal.
UBQ 180 LAB 9T1BCV-XX	La Belle, freestanding, seamless, Colour on Demand (Quarry [®]), incl. pre-fitted Multiplex Trio (chrome plated), Excellence	1800 x 800	1200 x 483	500	200	98,9			1
UBQ 180 LAB 9W1BCV-XX	La Belle, freestanding, seamless, Colour on Demand (Quarry [®]), incl. waste/overflow chrome-plated, Excellence								1

Accessories for baths:

Article number	Description	Price
UCCON0475	Pipe interruptor, incl. connections	
U906100XX	Multifunction cushion, foam, 240 x 150 x 50 mm	

Made-to-order production - Colour on Demand: 3 week delivery period. Please make sure to use the **order form** that you will find immediately after the chapter on baths on page 578-579, so that we can complete the order for you.

XX = Colour code to be indicated
 For further information on colours, please see the page at the beginning of this section.
 Further information on whirlpool systems please see page 585.

LEGATO Duo (Rectangle 1700 x 700) Acrylic

€ excl. VAT

Not included in scope of delivery: Set of bath feet is not supplied as standard. Requires extended waste/overflow combination.

Technical information: The whirlpool system IP (Special Combipool Invisible) for baths in color Stone White (RW) will be delivered with Stone White (RW) colored jets. For all other pools in the color RW, the jets remain in Chrome.

Matching furniture programme: Legato

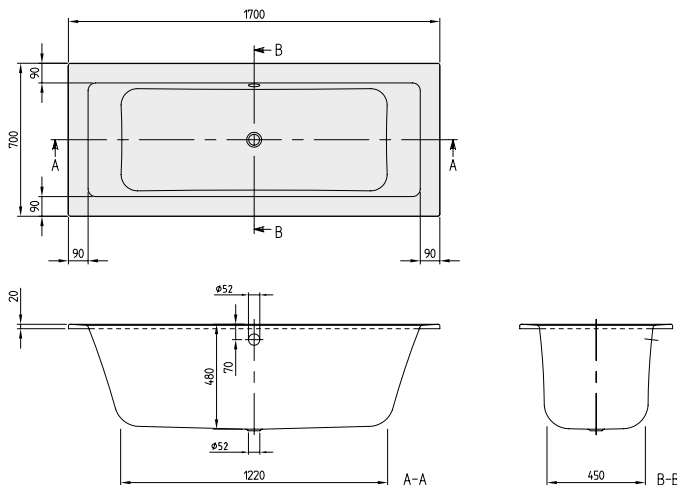

h = Installation height (min - max)	
Bath	605 - 655
Profibox 2.0 without system	585 - 585
Profibox 2.0 incl. System	625 - 665

Article number	Description	Size l x w	Bottom l x w	Depth	Litres incl. 1 pers	Weight (kg)	01	RW	pcs/pal.
UBA 177 LEG 2V-XX	Legato	1700 x 700	1220 x 450	480	165	22			8

Accessories for baths:

Article number	Description	Price
U99740000	Bath feet, plastic, for baths with even bottom, adjustable from 130 à 180 mm	
U90950461	Multiplex waste/overflow combination, chrome	
UCCON0475	Pipe interruptor, incl. connections	
U90600361	Multiplex Trio Outlet/overflow fitting with water inlet, chrome	
U90600461	Multiplex Trio Outlet/overflow fitting with water inlet and pipe interrupter, chrome	
U90170061	Handgrips, 1 pair = 2 grips, chrome	
U906100XX	Multifunction cushion, foam, 240 x 150 x 50 mm	

Preassembled bath options in combination with:

For order form, see fold-out page on the right-hand side	only bath	Airpools		Hydropools		Combipools		Special Combipools	
		AE	AC	HE	HC	CE	CC	IP	AP
Profibox 2.0 alcove	○	○	○	○	○	○	○	-	-
Profibox 2.0 corner	○	○	○	○	○	○	○	-	-
TouchLight	○	-	-	-	-	-	-	-	-

Whirlpool Systems		Airpools		Hydropools		Combipools		Special Combipools	
Article number	Description	AE	AC	HE	HC	CE	CC	IP	AP
U__ 177 LEG 2A ½ V 01	Price of whirlpool system incl. bath								
U__ 177 LEG 2A ½ V RW	Price of whirlpool system incl. bath								
U__ 177 LEG 2B ½ V 01	Price of whirlpool system incl. bath incl. Multiplex Trio								
U__ 177 LEG 2B ½ V RW	Price of whirlpool system incl. bath incl. Multiplex Trio								

For the following whirlpool systems the technology protrudes:

Technical parts 1	Side 1-3	Side 2-4	Side 3-4	Technical parts 2	Side 1-2	Side 1-3	Side 2-4
	-	-	-		-	-	-
	-	-	-		-	-	-
	-	-	-		-	-	-
	-	-	-		-	-	-
	-	-	-		-	-	-
	-	-	-		-	-	-
	-	-	-		-	-	-

Please replace __ in article number with whirlpool code.
 Please replace ½ in article number with desired position of technical equipment (1 = Layout 1, 2 = Layout 2). The back jets are located at the end at which the technical equipment is installed.
For further options use the order form (see right-hand fold-out page)

Technical parts 1

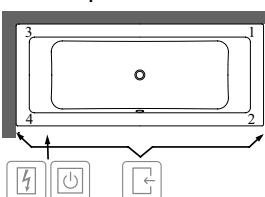

Technical parts 2

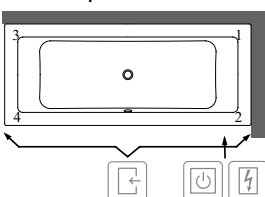

- Accessible via
- Control box
- Rim control

This symbol "O" means this option is possible

XX = Colour code to be indicated
 For further information on colours, please see the page at the beginning of this section.
 Further information on whirlpool systems please see page 585.

BATHS

LEGATO Duo (Rectangle 1700 x 750) Acrylic

€ excl. VAT

Not included in scope of delivery: Set of bath feet is not supplied as standard. Requires extended waste/overflow combination.

Technical information: The whirlpool system IP (Special Combipool Invisible) for baths in color Stone White (RW) will be delivered with Stone White (RW) colored jets. For all other pools in the color RW, the jets remain in Chrome.

Matching furniture programme: Legato

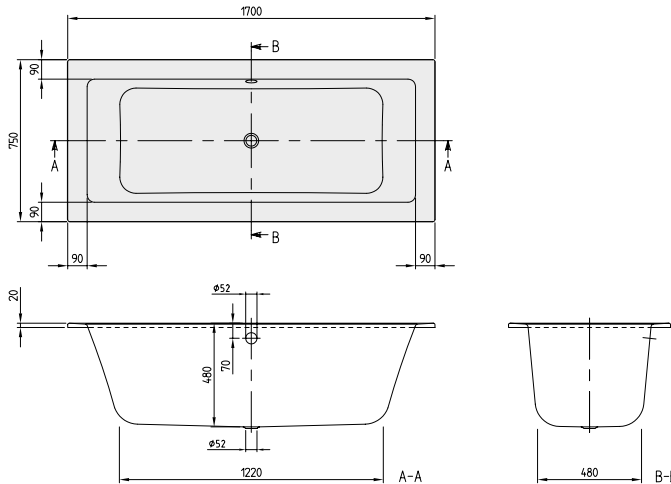

h = Installation height (min - max)	
Bath	605 - 655
Profibox 2.0 without system	585 - 585
Profibox 2.0 incl. System	625 - 665

Article number	Description	Size l x w	Bottom l x w	Depth	Litres incl. 1 pers	Weight (kg)	01	RW	pcs/pal.
UBA 170 LEG 2V-XX	Legato	1700 x 750	1220 x 480	480	170	22			15

Accessories for baths:

Article number	Description	Price
U99740000	Bath feet, plastic, for baths with even bottom, adjustable from 130 à 180 mm	
U90950461	Multiplex waste/overflow combination, chrome	
UCCON0475	Pipe interruptor, incl. connections	
U90600361	Multiplex Trio Outlet/overflow fitting with water inlet, chrome	
U90600461	Multiplex Trio Outlet/overflow fitting with water inlet and pipe interrupter, chrome	
U90170061	Handgrips, 1 pair = 2 grips, chrome	
U906100XX	Multifunction cushion, foam, 240 x 150 x 50 mm	

Preassembled bath options in combination with: For order form, see fold-out page on the right-hand side	only bath	Airpools		Hydropools		Combipools		Special Combipools	
		AE	AC	HE	HC	CE	CC	IP	AP
Profibox 2.0 alcove	○	○	○	○	○	○	○	○	-
Profibox 2.0 corner	○	○	○	○	○	○	○	○	-
TouchLight	○	-	-	-	-	-	-	-	-

Whirlpool Systems		Airpools		Hydropools		Combipools		Special Combipools	
Article number	Description	AE	AC	HE	HC	CE	CC	IP	AP
U__ 170 LEG 2A ½ V 01	Price of whirlpool system incl. bath								
U__ 170 LEG 2A ½ V RW	Price of whirlpool system incl. bath								
U__ 170 LEG 2B ½ V 01	Price of whirlpool system incl. bath incl. Multiplex Trio								
U__ 170 LEG 2B ½ V RW	Price of whirlpool system incl. bath incl. Multiplex Trio								

For the following whirlpool systems the technology protrudes:

Technical parts 1	Side 3-4	-	-	-	-	-	-	-	+40
Technical parts 2	Side 1-2	-	-	-	-	-	-	-	+40

Please replace __ in article number with whirlpool code.

Please replace ½ in article number with desired position of technical equipment (1 = Layout 1, 2 = Layout 2). The back jets are located at the end at which the technical equipment is installed.

For further options use the order form (see right-hand fold-out page)

Technical parts 1

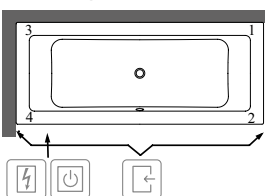

Technical parts 2

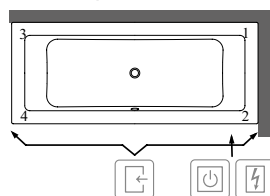

- Accessible via
- Control box
- Rim control

This symbol "○" means this option is possible

XX = Colour code to be indicated

For further information on colours, please see the page at the beginning of this section.

Further information on whirlpool systems please see page 585.

LEGATO Duo (Rectangle 1800 x 800) Acrylic

€ excl. VAT

Not included in scope of delivery:

Set of bath feet is not supplied as standard.
Requires extended waste/overflow combination.

Technical information:

The whirlpool system IP (Special Combipool Invisible) for baths in color Stone White (RW) will be delivered with Stone White (RW) colored jets. For all other pools in the color RW, the jets remain in Chrome.

Matching furniture programme:

Legato

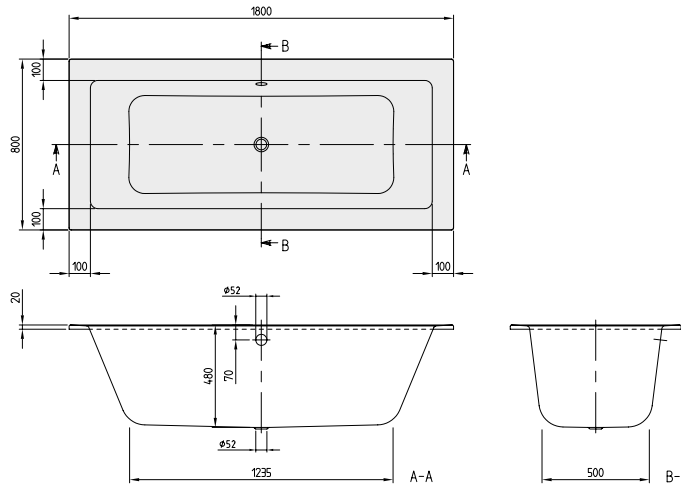

h = Installation height (min - max)	
Bath	605 - 655
Profibox 2.0 without system	585 - 585
Profibox 2.0 incl. System	625 - 665

Article number	Description	Size l x w	Bottom l x w	Depth	Litres incl. 1 pers	Weight (kg)	01	RW	pcs/pal.
UBA 180 LEG 2V-XX	Legato	1800 x 800	1235 x 500	480	198	24			15

Accessories for baths:

Article number	Description	Price
U99740000	Bath feet, plastic, for baths with even bottom, adjustable from 130 à 180 mm	
U90950461	Multiplex waste/overflow combination, chrome	
UCCON0475	Pipe interrupter, incl. connections	
U90600361	Multiplex Trio Outlet/overflow fitting with water inlet, chrome	
U90600461	Multiplex Trio Outlet/overflow fitting with water inlet and pipe interrupter, chrome	
U90170061	Handgrips, 1 pair = 2 grips, chrome	
U906100XX	Multifunction cushion, foam, 240 x 150 x 50 mm	

Preassembled bath options in combination with: For order form, see fold-out page on the right-hand side	only bath	Airpools		Hydropools		Combipools		Special Combipools	
		AE	AC	HE	HC	CE	CC	IP	AP
Profibox 2.0 alcove	○	○	○	○	○	○	○	○	○
Profibox 2.0 corner	○	○	○	○	○	○	○	○	○
TouchLight	○	-	-	-	-	-	-	-	-

Whirlpool Systems		Airpools		Hydropools		Combipools		Special Combipools	
Article number	Description	AE	AC	HE	HC	CE	CC	IP	AP
U__ 180 LEG 2A ½ V 01	Price of whirlpool system incl. bath								
U__ 180 LEG 2A ½ V RW	Price of whirlpool system incl. bath								
U__ 180 LEG 2B ½ V 01	Price of whirlpool system incl. bath incl. Multiplex Trio								
U__ 180 LEG 2B ½ V RW	Price of whirlpool system incl. bath incl. Multiplex Trio								

Please replace __ in article number with whirlpool code.
Please replace ½ in article number with desired position of technical equipment (1 = Layout 1, 2 = Layout 2). The back jets are located at the end at which the technical equipment is installed.
For further options use the order form (see right-hand fold-out page)

Technical parts 1

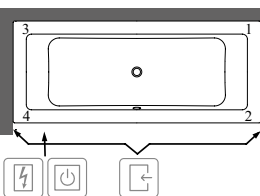

Technical parts 2

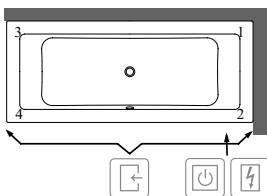

- Accessible via
- Control box
- Rim control

This symbol "O" means this option is possible

XX = Colour code to be indicated

For further information on colours, please see the page at the beginning of this section.

Further information on whirlpool systems please see page 585.

BATHS

LEGATO Duo (Rectangle 1900 x 900) Acrylic

€ excl. VAT

Not included in scope of delivery:

Set of bath feet is not supplied as standard.
Requires extended waste/overflow combination.

Technical information:

The whirlpool system IP (Special Combipool Invisible) for baths in color Stone White (RW) will be delivered with Stone White (RW) colored jets. For all other pools in the color RW, the jets remain in Chrome.

Matching furniture programme:

Legato

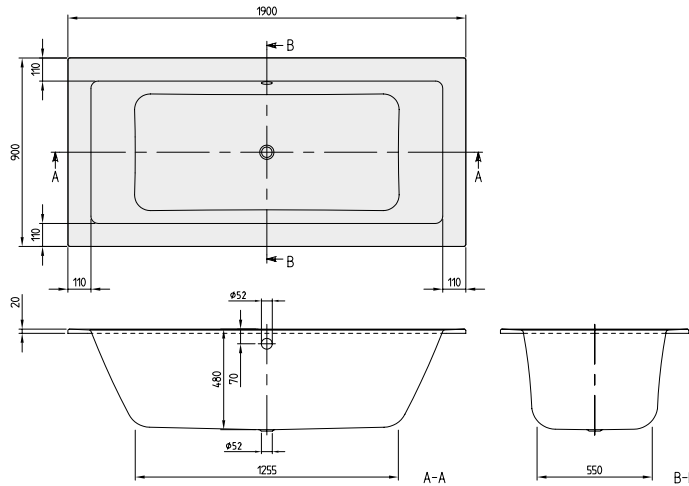

h = Installation height (min - max)	
Bath	605 - 655
Profibox 2.0 without system	585 - 585
Profibox 2.0 incl. System	625 - 665

Article number	Description	Size l x w	Bottom l x w	Depth	Litres incl. 1 pers	Weight (kg)	01	RW	pcs/pal.
UBA 199 LEG 2V-XX	Legato	1900 x 900	1255 x 550	480	236	27			15

Accessories for baths:

Article number	Description	Price
U99740000	Bath feet, plastic, for baths with even bottom, adjustable from 130 à 180 mm	
U90950461	Multiplex waste/overflow combination, chrome	
UCCON0475	Pipe interruptor, incl. connections	
U90600361	Multiplex Trio Outlet/overflow fitting with water inlet, chrome	
U90600461	Multiplex Trio Outlet/overflow fitting with water inlet and pipe interruptor, chrome	
U90170061	Handgrips, 1 pair = 2 grips, chrome	
U906100XX	Multifunction cushion, foam, 240 x 150 x 50 mm	

Preassembled bath options in combination with: For order form, see fold-out page on the right-hand side	only bath	Airpools		Hydropools		Combipools		Special Combipools	
		AE	AC	HE	HC	CE	CC	IP	AP
Profibox 2.0 alcove	○	○	○	○	○	○	○	○	○
Profibox 2.0 corner	○	○	○	○	○	○	○	○	○
TouchLight	○	-	-	-	-	-	-	-	-

Whirlpool Systems		Airpools		Hydropools		Combipools		Special Combipools	
Article number	Description	AE	AC	HE	HC	CE	CC	IP	AP
U__ 199 LEG 2A ½ V 01	Price of whirlpool system incl. bath								
U__ 199 LEG 2A ½ V RW	Price of whirlpool system incl. bath								
U__ 199 LEG 2B ½ V 01	Price of whirlpool system incl. bath incl. Multiplex Trio								
U__ 199 LEG 2B ½ V RW	Price of whirlpool system incl. bath incl. Multiplex Trio								

Please replace __ in article number with whirlpool code.

Please replace ½ in article number with desired position of technical equipment (1 = Layout 1, 2 = Layout 2). The back jets are located at the end at which the technical equipment is installed.

For further options use the order form (see right-hand fold-out page)

Technical parts 1

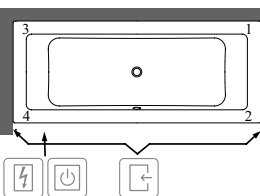

Technical parts 2

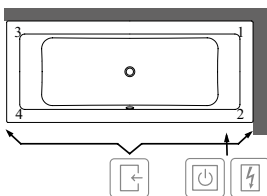

- Accessible via
- Control box
- Rim control

This symbol "○" means this option is possible

XX = Colour code to be indicated

For further information on colours, please see the page at the beginning of this section.

Further information on whirlpool systems please see page 585.

LIBRA Solo (Rectangle 1600 x 700) Quarryl®

€ excl. VAT

Included in scope of delivery:

Set of bath feet is supplied as standard (self-adhesive), adjustable from 130 à 180 mm.

Not included in scope of delivery:

Requires extended waste/overflow combination.

Technical information:

Overflow hole possible in one of 3 different positions. Holesaw (for drilling the overflow hole) included.

Whirlpool systems available on request.

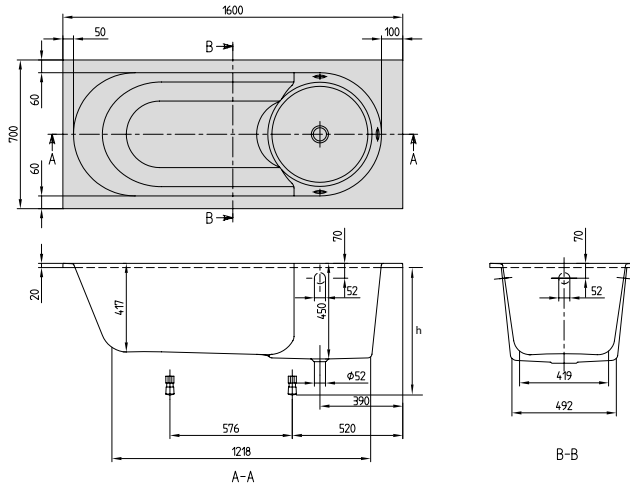

BATHS

h = Installation height (min - max)	
Bath	585 - 635

Article number	Description	Size l x w	Bottom l x w	Depth	Litres incl. 1 pers	Weight (kg)	01	pcs/pal.
UBQ 167 LIB 2V-XX	Libra	1600 x 700	1220 x 420	450	120	38,8		8

Accessories for baths:

Article number	Description	Price
U90950461	Multiplex waste/overflow combination, chrome	
UCCON0475	Pipe interruptor, incl. connections	
U90600361	Multiplex Trio Outlet/overflow fitting with water inlet, chrome	
U90600461	Multiplex Trio Outlet/overflow fitting with water inlet and pipe interrupter, chrome	
U90170061	Handgrips, 1 pair = 2 grips, chrome	
U906100XX	Multifunction cushion, foam, 240 x 150 x 50 mm	

Preassembled bath options in combination with:

For order form, see fold-out page on the right-hand side

TouchLight	Price

XX = Colour code to be indicated
 For further information on colours, please see the page at the beginning of this section.
 Further information on whirlpool systems please see page 585.

LIBRA Solo (Rectangle 1700 x 750) Quarryl®

€ excl. VAT

Included in scope of delivery:

Set of bath feet is supplied as standard (self-adhesive), adjustable from 130 à 180 mm.

Not included in scope of delivery:

Requires extended waste/overflow combination.

Technical information:

Overflow hole possible in one of 3 different positions. Holesaw (for drilling the overflow hole) included.

Whirlpool systems available on request.

United available for whirlpool systems on request

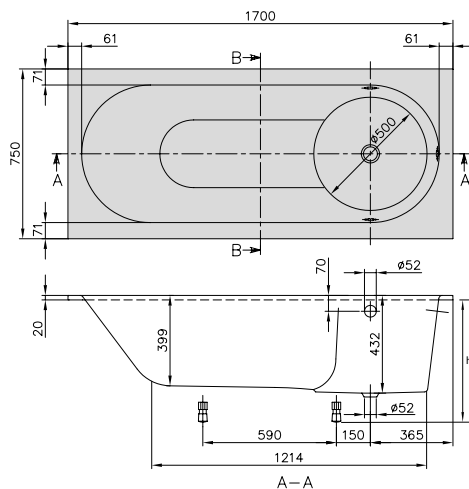

h = Installation height (min - max)	
Bath	570 - 620
UNITED without system	610 - 610
UNITED incl. System	610 - 610
Profibox 2.0 without system	585 - 585
Profibox 2.0 incl. System	625 - 665

Article number	Description	Size l x w	Bottom l x w	Depth	Litres incl. 1 pers	Weight (kg)	01	pcs/pal.
UBQ 170 LIB 2V-XX	Libra	1700 x 750	1210 x 420	432	125	37,2		8

Accessories for baths:

Article number	Description	Price
U90950461	Multiplex waste/overflow combination, chrome	
UCCON0475	Pipe interruptor, incl. connections	
U90600361	Multiplex Trio Outlet/overflow fitting with water inlet, chrome	
U90600461	Multiplex Trio Outlet/overflow fitting with water inlet and pipe interruptor, chrome	
U90170061	Handgrips, 1 pair = 2 grips, chrome	
U906100XX	Multifunction cushion, foam, 240 x 150 x 50 mm	

Preassembled bath options in combination with:

For order form, see fold-out page on the right-hand side

	Price
UNITED Free-standing	
UNITED Corner	
Profibox 2.0 alcove	
Profibox 2.0 corner	
TouchLight	

XX = Colour code to be indicated

For further information on colours, please see the page at the beginning of this section.

Further information on whirlpool systems please see page 585.

LIBRA Solo (Rectangle 1800 x 800) Quarryl®

€ excl. VAT

Included in scope of delivery:

Set of bath feet is supplied as standard (self-adhesive), adjustable from 130 à 180 mm.

Not included in scope of delivery:

Requires extended waste/overflow combination.

Technical information:

Overflow hole possible in one of 3 different positions. Holesaw (for drilling the overflow hole) included.

Whirlpool systems available on request.

United available for whirlpool systems on request

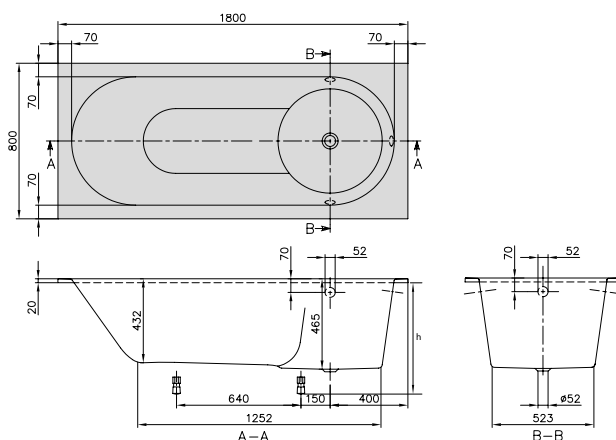

Quaryl®

h = Installation height (min - max)	
Bath	600 - 650
UNITED without system	610 - 610
UNITED incl. System	610 - 610
Profibox 2.0 without system	585 - 585
Profibox 2.0 incl. System	625 - 665

Article number	Description	Size l x w	Bottom l x w	Depth	Litres incl. 1 pers	Weight (kg)	01	pcs/pal.
UBQ 180 LIB 2V-XX	Libra	1800 x 800	1250 x 450	465	175	44,7		8

Accessories for baths:

Article number	Description	Price
U90950461	Multiplex waste/overflow combination, chrome	
UCCON0475	Pipe interruptor, incl. connections	
U90600361	Multiplex Trio Outlet/overflow fitting with water inlet, chrome	
U90600461	Multiplex Trio Outlet/overflow fitting with water inlet and pipe interruptor, chrome	
U90170061	Handgrips, 1 pair = 2 grips, chrome	
U906100XX	Multifunction cushion, foam, 240 x 150 x 50 mm	

Preassembled bath options in combination with:

For order form, see fold-out page on the right-hand side

	Price
UNITED Free-standing	
UNITED Corner	
Profibox 2.0 alcove	
Profibox 2.0 corner	
TouchLight	

XX = Colour code to be indicated

For further information on colours, please see the page at the beginning of this section.

Further information on whirlpool systems please see page 585.

LOOP & FRIENDS SQUARE Duo with square inner form (Rectangle 1700 x 700) Acrylic

€ excl. VAT

Not included in scope of delivery: Set of bath feet is not supplied as standard.
Requires extended waste/overflow combination.

Matching sanitary ceramics: Loop & Friends

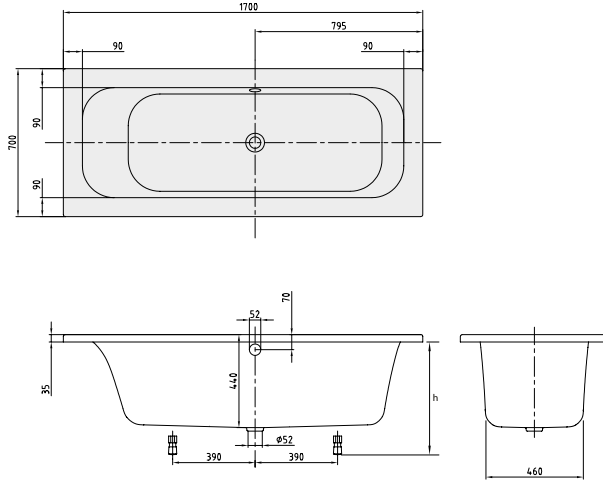

h = Installation height (min - max)	
Bath	545 - 595
Whirlpool system	585 - 625
Profibox 2.0 without system	585 - 585
Profibox 2.0 incl. System	625 - 625

Article number	Description	Size l x w	Bottom l x w	Depth	Litres incl. 1 pers	Weight (kg)	01	pcs/pal.
UBA 177 LFS 2V-XX	Loop & Friends, Duo, with square inner form	1700 x 700	1200 x 460	440	120	21		10

Accessories for baths:

Article number	Description	Price
U99740000	Bath feet, plastic, for baths with even bottom, adjustable from 130 à 180 mm	
U90950461	Multiplex waste/overflow combination, chrome	
UCCON0475	Pipe interruptor, incl. connections	
U90600361	Multiplex Trio Outlet/overflow fitting with water inlet, chrome	
U90600461	Multiplex Trio Outlet/overflow fitting with water inlet and pipe interrupter, chrome	
U90170061	Handgrips, 1 pair = 2 grips, chrome	
U906100XX	Multifunction cushion, foam, 240 x 150 x 50 mm	

Preassembled bath options in combination with: For order form, see fold-out page on the right-hand side	only bath	Airpools		Hydropools		Combipools		Special Combipools	
		AE	AC	HE	HC	CE	CC	IP	AP
Profibox 2.0 alcove	<input type="radio"/>	<input type="radio"/>	<input type="radio"/>	<input type="radio"/>	<input type="radio"/>	<input type="radio"/>	<input type="radio"/>	<input type="radio"/>	<input type="radio"/>
Profibox 2.0 corner	<input type="radio"/>	<input type="radio"/>	<input type="radio"/>	<input type="radio"/>	<input type="radio"/>	<input type="radio"/>	<input type="radio"/>	<input type="radio"/>	<input type="radio"/>
TouchLight	<input type="radio"/>	-	-	-	-	-	-	-	-

Whirlpool Systems	Article number	Description	Airpools		Hydropools		Combipools		Special Combipools	
			AE	AC	HE	HC	CE	CC	IP	AP
	U__ 177 LFS 2A ½ V XX	Price of whirlpool system incl. bath								
	U__ 177 LFS 2B ½ V XX	Price of whirlpool system incl. bath incl. Multiplex Trio								

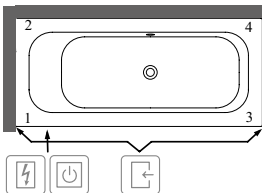

Please replace __ in article number with whirlpool code.
Please replace ½ in article number with desired position of technical equipment (1 = Layout 1, 2 = Layout 2). The back jets are located at the end at which the technical equipment is installed.
For further options use the order form (see right-hand fold-out page)

Technical parts 1

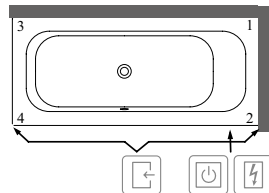

Technical parts 2



-  Accessible via
-  Control box
-  Rim control

This symbol "O" means this option is possible

XX = Colour code to be indicated

For further information on colours, please see the page at the beginning of this section.

Further information on whirlpool systems please see page 585.

LOOP & FRIENDS SQUARE Duo with square inner form (Rectangle 1700 x 750) Acrylic

€ excl. VAT

Not included in scope of delivery: Set of bath feet is not supplied as standard.
Requires extended waste/overflow combination.

Matching sanitary ceramics: Loop & Friends

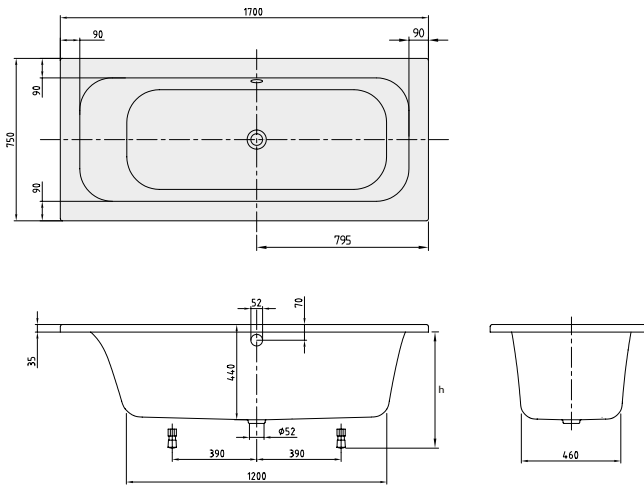

h = Installation height (min - max)	
Bath	545 - 595
Whirlpool system	585 - 625
Profibox 2.0 without system	585 - 585
Profibox 2.0 incl. System	625 - 625

Article number	Description	Size l x w	Bottom l x w	Depth	Litres incl. 1 pers	Weight (kg)	01	pcs/pal.
UBA 170 LFS 2V-XX	Loop & Friends, Duo, with square inner form	1700 x 750	1200 x 460	440	130	21		10

Accessories for baths:

Article number	Description	Price
U99740000	Bath feet, plastic, for baths with even bottom, adjustable from 130 à 180 mm	
U90950461	Multiplex waste/overflow combination, chrome	
UCCON0475	Pipe interruptor, incl. connections	
U90600361	Multiplex Trio Outlet/overflow fitting with water inlet, chrome	
U90600461	Multiplex Trio Outlet/overflow fitting with water inlet and pipe interrupter, chrome	
U90170061	Handgrips, 1 pair = 2 grips, chrome	
U906100XX	Multifunction cushion, foam, 240 x 150 x 50 mm	

Preassembled bath options in combination with: For order form, see fold-out page on the right-hand side	only bath	Airpools		Hydropools		Combipools		Special Combipools	
		AE	AC	HE	HC	CE	CC	IP	AP
Profibox 2.0 alcove	<input type="radio"/>	<input type="radio"/>	<input type="radio"/>	<input type="radio"/>	<input type="radio"/>	<input type="radio"/>	<input type="radio"/>	<input type="radio"/>	<input type="radio"/>
Profibox 2.0 corner	<input type="radio"/>	<input type="radio"/>	<input type="radio"/>	<input type="radio"/>	<input type="radio"/>	<input type="radio"/>	<input type="radio"/>	<input type="radio"/>	<input type="radio"/>
TouchLight	<input type="radio"/>	-	-	-	-	-	-	-	-

Whirlpool Systems	Article number	Description	Airpools		Hydropools		Combipools		Special Combipools	
			AE	AC	HE	HC	CE	CC	IP	AP
	U__ 170 LFS 2A ½ V XX	Price of whirlpool system incl. bath								
	U__ 170 LFS 2B ½ V XX	Price of whirlpool system incl. bath incl. Multiplex Trio								

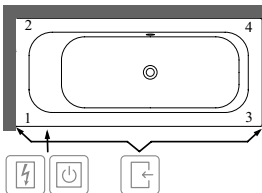

Please replace __ in article number with whirlpool code.
Please replace ½ in article number with desired position of technical equipment (1 = Layout 1, 2 = Layout 2). The back jets are located at the end at which the technical equipment is installed.
For further options use the order form (see right-hand fold-out page)

Technical parts 1

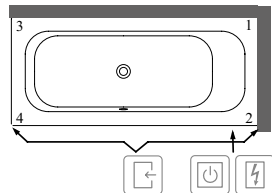

Technical parts 2



-  Accessible via
-  Control box
-  Rim control

This symbol "O" means this option is possible

XX = Colour code to be indicated

For further information on colours, please see the page at the beginning of this section.

Further information on whirlpool systems please see page 585.

LOOP & FRIENDS SQUARE Duo with square inner form (Rectangle 1800 x 800) Acrylic

€ excl. VAT

Not included in scope of delivery: Set of bath feet is not supplied as standard.
Requires extended waste/overflow combination.

Matching sanitary ceramics: Loop & Friends

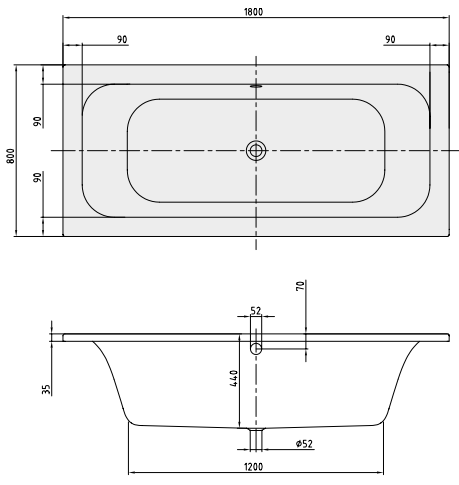

h = Installation height (min - max)	
Bath	545 - 595
Whirlpool system	585 - 625
Profibox 2.0 without system	585 - 585
Profibox 2.0 incl. System	625 - 625

Article number	Description	Size l x w	Bottom l x w	Depth	Litres incl. 1 pers	Weight (kg)	01	pcs/pal.
UBA 180 LFS 2V-XX	Loop & Friends, Duo, with square inner form	1800 x 800	1200 x 480	440	150	23		10

Accessories for baths:

Article number	Description	Price
U99740000	Bath feet, plastic, for baths with even bottom, adjustable from 130 à 180 mm	
U90950461	Multiplex waste/overflow combination, chrome	
UCCON0475	Pipe interruptor, incl. connections	
U90600361	Multiplex Trio Outlet/overflow fitting with water inlet, chrome	
U90600461	Multiplex Trio Outlet/overflow fitting with water inlet and pipe interrupter, chrome	
U90170061	Handgrips, 1 pair = 2 grips, chrome	
U906100XX	Multifunction cushion, foam, 240 x 150 x 50 mm	

Preassembled bath options in combination with: For order form, see fold-out page on the right-hand side	only bath	Airpools		Hydropools		Combipools		Special Combipools	
		AE	AC	HE	HC	CE	CC	IP	AP
Profibox 2.0 alcove	<input type="radio"/>	<input type="radio"/>	<input type="radio"/>	<input type="radio"/>	<input type="radio"/>	<input type="radio"/>	<input type="radio"/>	<input type="radio"/>	<input type="radio"/>
Profibox 2.0 corner	<input type="radio"/>	<input type="radio"/>	<input type="radio"/>	<input type="radio"/>	<input type="radio"/>	<input type="radio"/>	<input type="radio"/>	<input type="radio"/>	<input type="radio"/>
TouchLight	<input type="radio"/>	-	-	-	-	-	-	-	-

Whirlpool Systems	Article number	Description	Airpools		Hydropools		Combipools		Special Combipools	
			AE	AC	HE	HC	CE	CC	IP	AP
	U__ 180 LFS 2A ½ V XX	Price of whirlpool system incl. bath								
	U__ 180 LFS 2B ½ V XX	Price of whirlpool system incl. bath incl. Multiplex Trio								

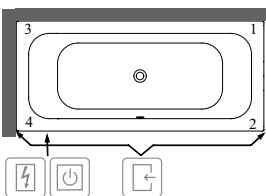

Please replace __ in article number with whirlpool code.
Please replace ½ in article number with desired position of technical equipment (1 = Layout 1, 2 = Layout 2). The back jets are located at the end at which the technical equipment is installed.
For further options use the order form (see right-hand fold-out page)

Technical parts 1

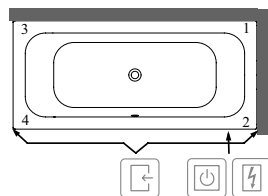

Technical parts 2



-  Accessible via
-  Control box
-  Rim control

This symbol "O" means this option is possible

XX = Colour code to be indicated

For further information on colours, please see the page at the beginning of this section.

Further information on whirlpool systems please see page 585.

LOOP & FRIENDS SQUARE Duo with square inner form (Rectangle 1900 x 900) Acrylic

€ excl. VAT

Not included in scope of delivery: Set of bath feet is not supplied as standard.
Requires extended waste/overflow combination.

Matching sanitary ceramics: Loop & Friends

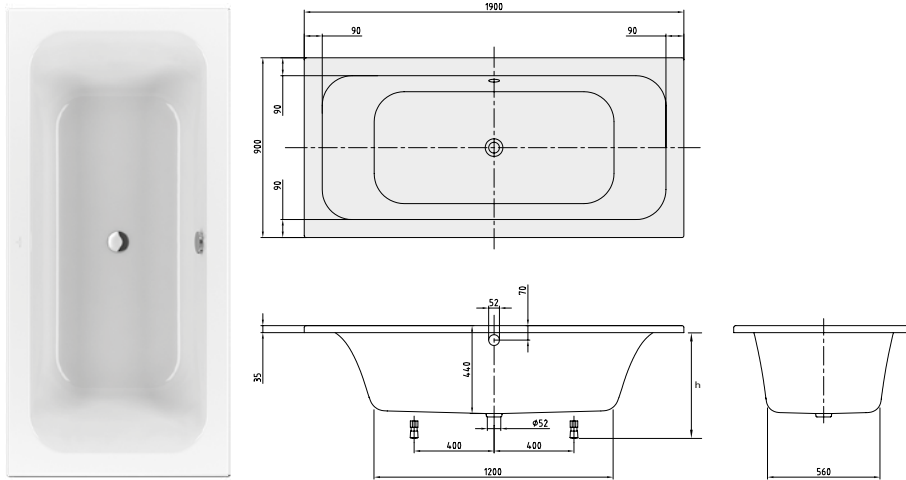

h = Installation height (min - max)	
Bath	545 - 595
Whirlpool system	585 - 625
Profibox 2.0 without system	585 - 585
Profibox 2.0 incl. System	625 - 625

Article number	Description	Size l x w	Bottom l x w	Depth	Litres incl. 1 pers	Weight (kg)	01	pcs/pal.
UBA 199 LFS 2V-XX	Loop & Friends, Duo, with square inner form	1900 x 900	1200 x 560	440	180	25		10

Accessories for baths:

Article number	Description	Price
U99740000	Bath feet, plastic, for baths with even bottom, adjustable from 130 à 180 mm	
U90950461	Multiplex waste/overflow combination, chrome	
UCCON0475	Pipe interruptor, incl. connections	
U90600361	Multiplex Trio Outlet/overflow fitting with water inlet, chrome	
U90600461	Multiplex Trio Outlet/overflow fitting with water inlet and pipe interrupter, chrome	
U90170061	Handgrips, 1 pair = 2 grips, chrome	
U906100XX	Multifunction cushion, foam, 240 x 150 x 50 mm	

Preassembled bath options in combination with: For order form, see fold-out page on the right-hand side	only bath	Airpools		Hydropools		Combipools		Special Combipools	
		AE	AC	HE	HC	CE	CC	IP	AP
Profibox 2.0 alcove	<input type="radio"/>	<input type="radio"/>	<input type="radio"/>	<input type="radio"/>	<input type="radio"/>	<input type="radio"/>	<input type="radio"/>	<input type="radio"/>	<input type="radio"/>
Profibox 2.0 corner	<input type="radio"/>	<input type="radio"/>	<input type="radio"/>	<input type="radio"/>	<input type="radio"/>	<input type="radio"/>	<input type="radio"/>	<input type="radio"/>	<input type="radio"/>
TouchLight	<input type="radio"/>	-	-	-	-	-	-	-	-

Whirlpool Systems	Article number	Description	Airpools		Hydropools		Combipools		Special Combipools	
			AE	AC	HE	HC	CE	CC	IP	AP
	U__ 199 LFS 2A ½ V XX	Price of whirlpool system incl. bath								
	U__ 199 LFS 2B ½ V XX	Price of whirlpool system incl. bath incl. Multiplex Trio								

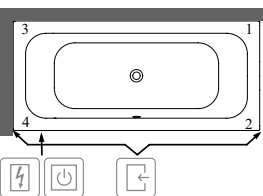

Please replace __ in article number with whirlpool code.
Please replace ½ in article number with desired position of technical equipment (1 = Layout 1, 2 = Layout 2). The back jets are located at the end at which the technical equipment is installed.
For further options use the order form (see right-hand fold-out page)

Technical parts 1

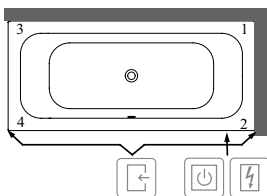

Technical parts 2



-  Accessible via
-  Control box
-  Rim control

This symbol "O" means this option is possible

XX = Colour code to be indicated

For further information on colours, please see the page at the beginning of this section.

Further information on whirlpool systems please see page 585.

BATHS

LOOP & FRIENDS SQUARE Duo with square inner form (Hexagonal 1900 x 900) Acrylic

€ excl. VAT

Not included in scope of delivery: Set of bath feet is not supplied as standard. Requires extended waste/overflow combination.

Technical information: In case of corner installation the diagonal dimension is 1344 mm.

Matching sanitary ceramics: Loop & Friends

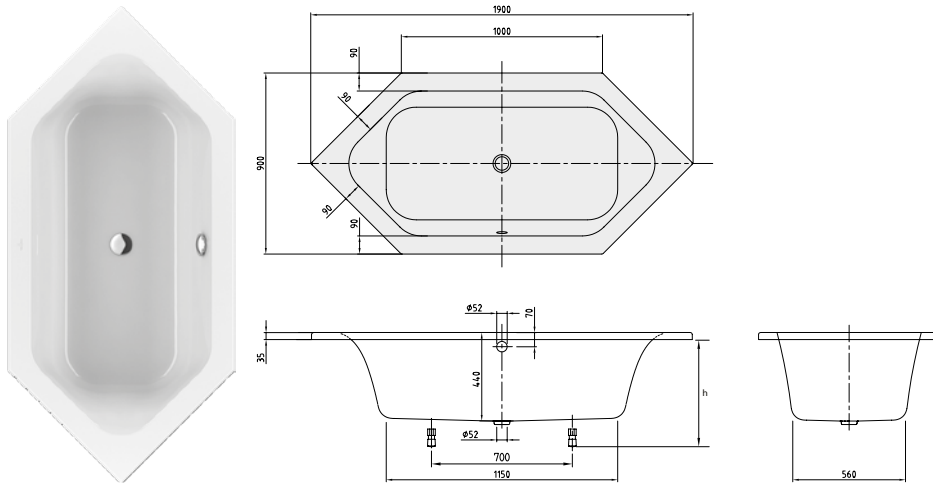

h = Installation height (min - max)	
Bath	545 - 595
Whirlpool system	585 - 625

Article number	Description	Size l x w	Bottom l x w	Depth	Litres incl. 1 pers	Weight (kg)	01	pcs/pal.
UBA 199 LFS 6V-XX	Loop & Friends, Duo, with square inner form	1900 x 900	1150 x 560	440	145	24		15

Accessories for baths:

Article number	Description	Price
U99740000	Bath feet, plastic, for baths with even bottom, adjustable from 130 à 180 mm	
U90950461	Multiplex waste/overflow combination, chrome	
UCCON0475	Pipe interruptor, incl. connections	
U90600361	Multiplex Trio Outlet/overflow fitting with water inlet, chrome	
U90600461	Multiplex Trio Outlet/overflow fitting with water inlet and pipe interruptor, chrome	
U90170061	Handgrips, 1 pair = 2 grips, chrome	
U906100XX	Multifunction cushion, foam, 240 x 150 x 50 mm	

Preassembled bath options in combination with:		only bath	Airpools		Hydropools		Combipools		Special Combipools	
For order form, see fold-out page on the right-hand side			AE	AC	HE	HC	CE	CC	IP	AP
TouchLight		○	-	-	-	-	-	-	-	-

Whirlpool Systems		Airpools		Hydropools		Combipools		Special Combipools	
Article number	Description	AE	AC	HE	HC	CE	CC	IP	AP
U__ 199 LFS 6A ½ V XX	Price of whirlpool system incl. bath								
U__ 199 LFS 6B ½ V XX	Price of whirlpool system incl. bath incl. Multiplex Trio								

For the following whirlpool systems the technology protrudes:

Technical parts	Side	AE	AC	HE	HC	CE	CC	IP	AP
Technical parts 1	Side 3-6	-	-	-	-	-	-	-	+40
	Side 4-6	-	-	-	-	-	-	-	+40
Technical parts 2	Side 1-5	-	-	-	-	-	-	-	+40
	Side 2-5	-	-	-	-	-	-	-	+40

Please replace __ in article number with whirlpool code.

Please replace ½ in article number with desired position of technical equipment (1 = Layout 1, 2 = Layout 2). The back jets are located at the end at which the technical equipment is installed.

For further options use the order form (see right-hand fold-out page)

Technical parts 1

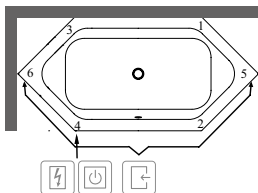

Technical parts 2

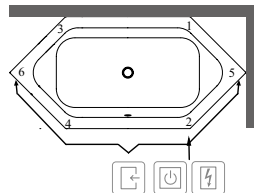

- Accessible via
- Control box
- Rim control

This symbol "○" means this option is possible

XX = Colour code to be indicated

For further information on colours, please see the page at the beginning of this section.

Further information on whirlpool systems please see page 585.

LOOP & FRIENDS SQUARE Duo with square inner form (Oval 1800 x 800) Acrylic

€ excl. VAT

Not included in scope of delivery: Set of bath feet is not supplied as standard.
Requires extended waste/overflow combination.

Matching sanitary ceramics: Loop & Friends

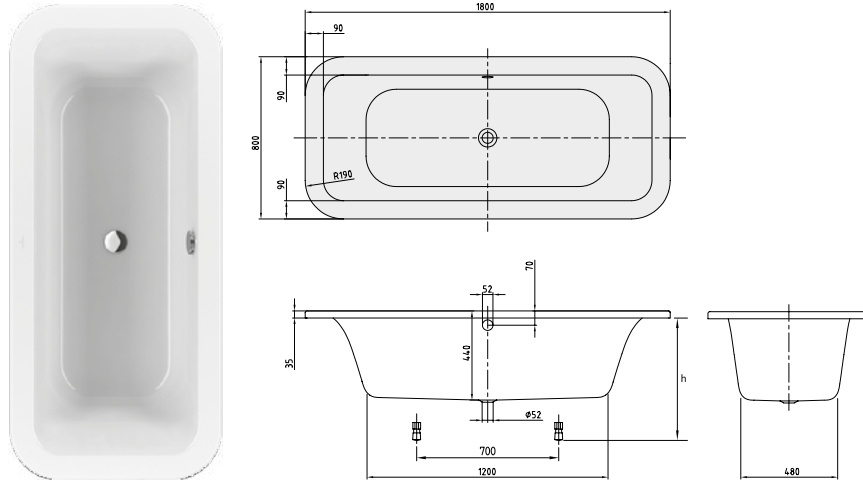

h = Installation height (min - max)	
Bath	545 - 595
Whirlpool system	585 - 625

Article number	Description	Size l x w	Bottom l x w	Depth	Litres incl. 1 pers	Weight (kg)	01	pcs/pal.
UBA 180 LFS 7V-XX	Loop & Friends, Duo, with square inner form	1800 x 800	1200 x 480	440	150	23		10

Accessories for baths:

Article number	Description	Price
U99740000	Bath feet, plastic, for baths with even bottom, adjustable from 130 à 180 mm	
U90950461	Multiplex waste/overflow combination, chrome	
UCCON0475	Pipe interruptor, incl. connections	
U90600361	Multiplex Trio Outlet/overflow fitting with water inlet, chrome	
U90600461	Multiplex Trio Outlet/overflow fitting with water inlet and pipe interrupter, chrome	
U90170061	Handgrips, 1 pair = 2 grips, chrome	
U906100XX	Multifunction cushion, foam, 240 x 150 x 50 mm	

Preassembled bath options in combination with: For order form, see fold-out page on the right-hand side	only bath	Airpools		Hydropools		Combipools		Special Combipools	
		AE	AC	HE	HC	CE	CC	IP	AP
TouchLight	○	-	-	-	-	-	-	-	-

Whirlpool Systems		Airpools		Hydropools		Combipools		Special Combipools	
Article number	Description	AE	AC	HE	HC	CE	CC	IP	AP
U__ 180 LFS 7A ½ V XX	Price of whirlpool system incl. bath								
U__ 180 LFS 7B ½ V XX	Price of whirlpool system incl. bath incl. Multiplex Trio								

Please replace __ in article number with whirlpool code.
Please replace ½ in article number with desired position of technical equipment (1 = Layout 1, 2 = Layout 2). The back jets are located at the end at which the technical equipment is installed.
For further options use the order form (see right-hand fold-out page)

Technical parts 1

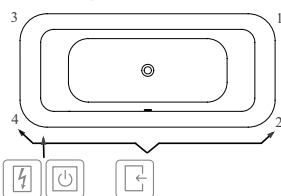

Technical parts 2

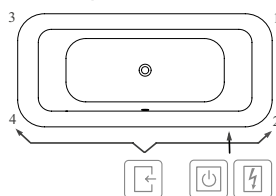

- Accessible via
- Control box
- Rim control

This symbol "○" means this option is possible

XX = Colour code to be indicated

For further information on colours, please see the page at the beginning of this section.

Further information on whirlpool systems please see page 585.

BATHS

LOOP & FRIENDS SQUARE Duo with square outer and inner form (Free-standing 1800 x 800) Acrylic

€ excl. VAT

Included in scope of delivery:

Matching outlet and overflow (Chrome) is supplied as standard.

Technical information:
Whirlpool systems available on request.
Matching sanitary ceramics:

Loop & Friends

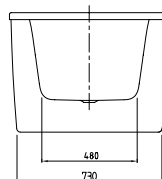
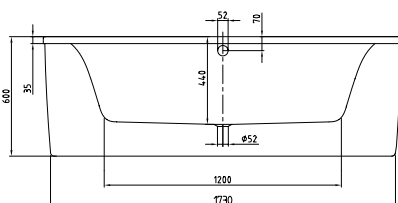
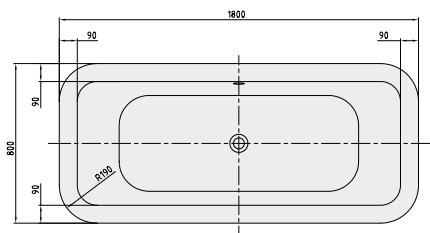

Article number	Description	Size l x w	Bottom l x w	Depth	Litres incl. 1 pers	Weight (kg)	01	pcs/pal.
UBA 180 LFS 7PDV-XX	Loop & Friends, Duo, freestanding, incl. panel in the same colour as the bath (Acrylic), incl. waste/overflow chrome-plated, with square outer and inner form	1800 x 800	1200 x 480	440	150	43		1

Accessories for baths:

Article number	Description	Price
UCCON0475	Pipe interrupter, incl. connections	
U90600361	Multiplex Trio Outlet/overflow fitting with water inlet, chrome	
U90600461	Multiplex Trio Outlet/overflow fitting with water inlet and pipe interrupter, chrome	
U90170061	Handgrips, 1 pair = 2 grips, chrome	
U906100XX	Multifunction cushion, foam, 240 x 150 x 50 mm	

Preassembled bath options in combination with:
For order form, see fold-out page on the right-hand side

TouchLight	Price

XX = Colour code to be indicated

For further information on colours, please see the page at the beginning of this section.

Further information on whirlpool systems please see page 585.

LOOP & FRIENDS SQUARE Duo with square outer and inner form (Free-standing 1800 x 800) Acrylic, Colour on Demand € excl. VAT

Included in scope of delivery: Including extended waste/overflow combination (chrome-plated).
Technical information: Whirlpool systems available on request.
Matching sanitary ceramics: Loop & Friends

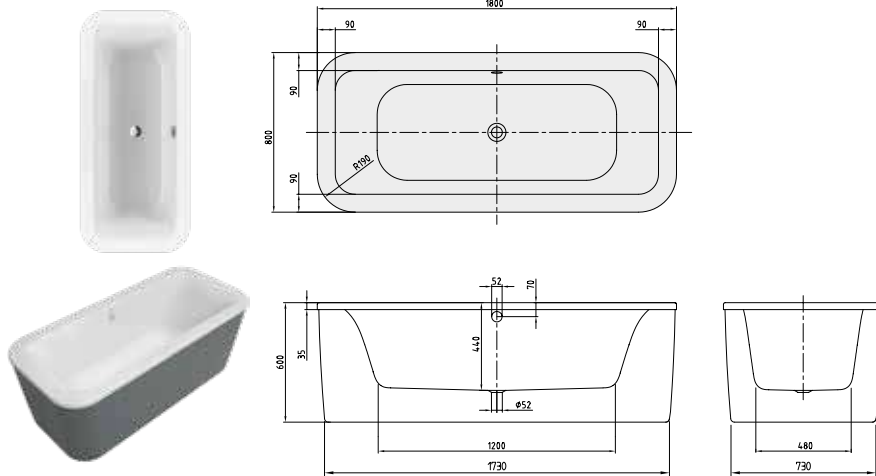

Article number	Description	Size l x w	Bottom l x w	Depth	Litres incl. 1 pers	Weight (kg)	01	pcs/pal.
UBA 180 LFS 7PDBCX-XX	Loop & Friends, Duo, freestanding, incl. panel in Colour on Demand (Acrylic), incl. waste/overflow chrome-plated, with square outer and inner form	1800 x 800	1200 x 480	440	150	43		1

Accessories for baths:

Article number	Description	Price
UCCON0475	Pipe interrupter, incl. connections	
U90600361	Multiplex Trio Outlet/overflow fitting with water inlet, chrome	
U90600461	Multiplex Trio Outlet/overflow fitting with water inlet and pipe interrupter, chrome	
U90170061	Handgrips, 1 pair = 2 grips, chrome	
U906100XX	Multifunction cushion, foam, 240 x 150 x 50 mm	

Preassembled bath options in combination with:

For order form, see fold-out page on the right-hand side	Price
TouchLight	

Made-to-order production - Colour on Demand: 3 week delivery period. Please make sure to use the **order form** that you will find immediately after the chapter on baths on page 578-579, so that we can complete the order for you.

XX = Colour code to be indicated
 For further information on colours, please see the page at the beginning of this section.
 Further information on whirlpool systems please see page 585.

LOOP & FRIENDS SQUARE with square inner form (Special shape 1750 x 1350) Acrylic

€ excl. VAT

Not included in scope of delivery: Set of bath feet is not supplied as standard.
Requires extended waste/overflow combination.

Matching sanitary ceramics: Loop & Friends

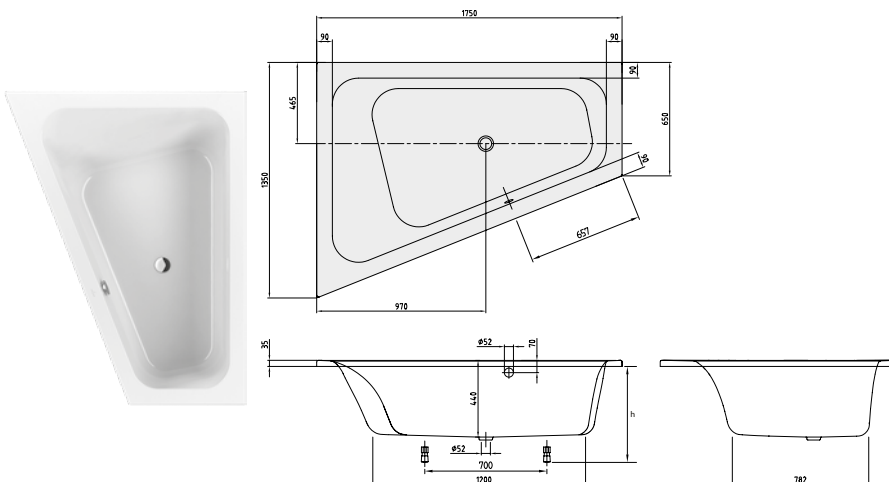

h = Installation height (min - max)	
Bath	545 - 595
Whirlpool system	585 - 625

Article number	Description	Size l x w	Bottom l x w	Depth	Litres incl. 1 pers	Weight (kg)	01	pcs/pal.
UBA 175 LFS 9LIV-XX	Loop & Friends, left hand version, with square inner form	1750 x 1350	1200 x 780	440	215	32		8

Accessories for baths:

Article number	Description	Price
U99740000	Bath feet, plastic, for baths with even bottom, adjustable from 130 à 180 mm	
U90950461	Multiplex waste/overflow combination, chrome	
UCCON0475	Pipe interruptor, incl. connections	
U90600361	Multiplex Trio Outlet/overflow fitting with water inlet, chrome	
U90600461	Multiplex Trio Outlet/overflow fitting with water inlet and pipe interruptor, chrome	
U90170061	Handgrips, 1 pair = 2 grips, chrome	
U906100XX	Multifunction cushion, foam, 240 x 150 x 50 mm	

Preassembled bath options in combination with: For order form, see fold-out page on the right-hand side	only bath	Airpools		Hydropools		Combipools		Special Combipools	
		AE	AC	HE	HC	CE	CC	IP	AP
TouchLight	○	-	-	-	-	-	-	-	-

Whirlpool Systems		Airpools		Hydropools		Combipools		Special Combipools	
Article number	Description	AE	AC	HE	HC	CE	CC	IP	AP
U_ 175 LFS LA 1 V XX	Price of whirlpool system incl. bath								
U_ 175 LFS LB 1 V XX	Price of whirlpool system incl. bath incl. Multiplex Trio								

Please replace _ _ in article number with whirlpool code.

For further options use the order form (see right-hand fold-out page)

Technical parts 1

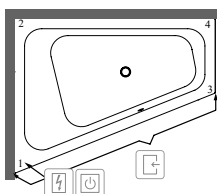

This symbol "○" means this option is possible

XX = Colour code to be indicated

For further information on colours, please see the page at the beginning of this section.

Further information on whirlpool systems please see page 585.

LOOP & FRIENDS SQUARE with square inner form (Special shape 1750 x 1350) Acrylic

€ excl. VAT

Not included in scope of delivery: Set of bath feet is not supplied as standard.
Requires extended waste/overflow combination.
Matching sanitary ceramics: Loop & Friends

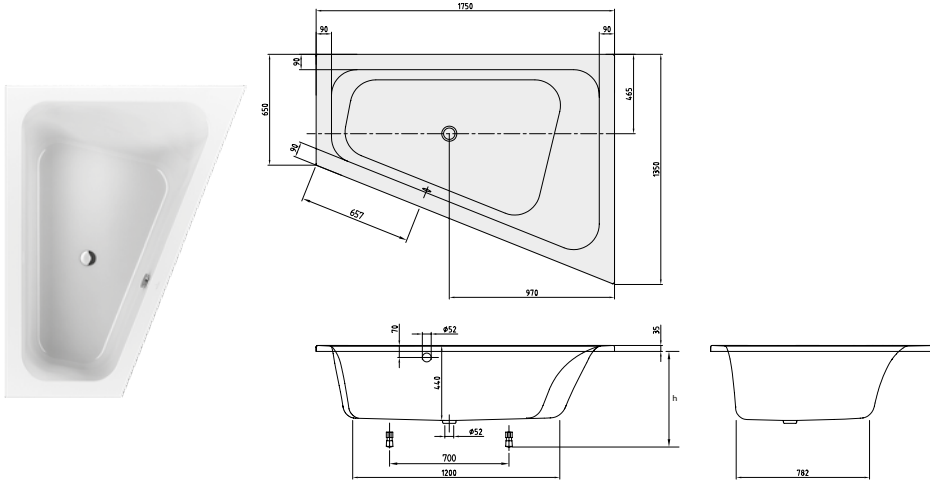

h = Installation height (min - max)	
Bath	545 - 595
Whirlpool system	585 - 625

Article number	Description	Size l x w	Bottom l x w	Depth	Litres incl. 1 pers	Weight (kg)	01	pcs/pal.
UBA 175 LFS 9REV-XX	Loop & Friends, right hand version, with square inner form	1750 x 1350	1200 x 780	440	215	32		8

Accessories for baths:

Article number	Description	Price
U99740000	Bath feet, plastic, for baths with even bottom, adjustable from 130 à 180 mm	
U90950461	Multiplex waste/overflow combination, chrome	
UCCON0475	Pipe interruptor, incl. connections	
U90600361	Multiplex Trio Outlet/overflow fitting with water inlet, chrome	
U90600461	Multiplex Trio Outlet/overflow fitting with water inlet and pipe interrupter, chrome	
U90170061	Handgrips, 1 pair = 2 grips, chrome	
U906100XX	Multifunction cushion, foam, 240 x 150 x 50 mm	

Preassembled bath options in combination with: For order form, see fold-out page on the right-hand side	only bath	Airpools		Hydropools		Combipools		Special Combipools	
		AE	AC	HE	HC	CE	CC	IP	AP
TouchLight	○	-	-	-	-	-	-	-	-

Whirlpool Systems		Airpools		Hydropools		Combipools		Special Combipools	
Article number	Description	AE	AC	HE	HC	CE	CC	IP	AP
U_ 175 LFS RA 1 V XX	Price of whirlpool system incl. bath								
U_ 175 LFS RB 1 V XX	Price of whirlpool system incl. bath incl. Multiplex Trio								

Please replace _ _ in article number with whirlpool code.
For further options use the order form (see right-hand fold-out page)

Technical parts 1

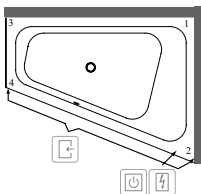

This symbol "○" means this option is possible

XX = Colour code to be indicated

For further information on colours, please see the page at the beginning of this section.

Further information on whirlpool systems please see page 585.

BATHS

LOOP & FRIENDS SQUARE Duo with square inner form (Corner 1400 x 1400) Acrylic

€ excl. VAT

Not included in scope of delivery: Set of bath feet is not supplied as standard.
Requires extended waste/overflow combination.

Matching sanitary ceramics: Loop & Friends

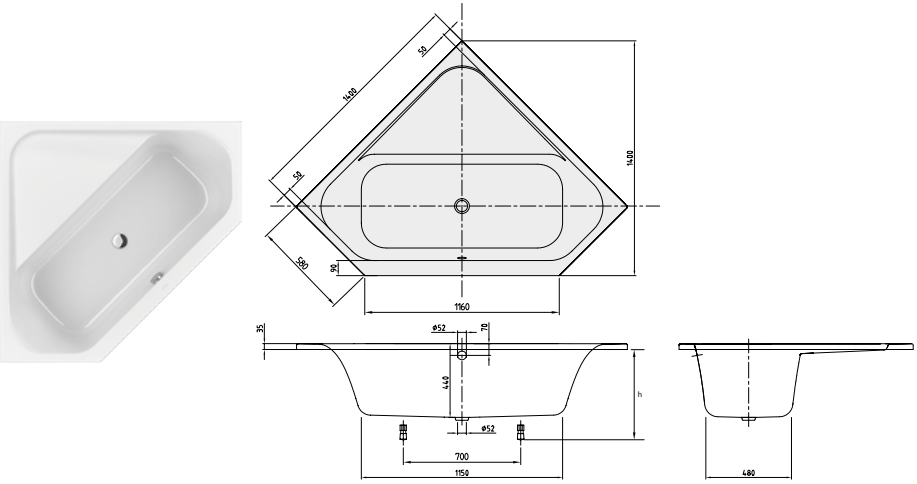

h = Installation height (min - max)	
Bath	545 - 595
Whirlpool system	585 - 625

Article number	Description	Size l x w	Bottom l x w	Depth	Litres incl. 1 pers	Weight (kg)	01	pcs/pal.
UBA 140 LFS 3V-XX	Loop & Friends, Duo, with square inner form	1400 x 1400	1150 x 480	440	160	26		8

Accessories for baths:

Article number	Description	Price
U99740000	Bath feet, plastic, for baths with even bottom, adjustable from 130 à 180 mm	
U90950461	Multiplex waste/overflow combination, chrome	
UCCON0475	Pipe interruptor, incl. connections	
U90600361	Multiplex Trio Outlet/overflow fitting with water inlet, chrome	
U90600461	Multiplex Trio Outlet/overflow fitting with water inlet and pipe interrupter, chrome	
U90170061	Handgrips, 1 pair = 2 grips, chrome	
U906100XX	Multifunction cushion, foam, 240 x 150 x 50 mm	

Preassembled bath options in combination with: For order form, see fold-out page on the right-hand side	only bath	Airpools		Hydropools		Combipools		Special Combipools	
		AE	AC	HE	HC	CE	CC	IP	AP
TouchLight	○	-	-	-	-	-	-	-	-

Whirlpool Systems		Airpools		Hydropools		Combipools		Special Combipools	
Article number	Description	AE	AC	HE	HC	CE	CC	IP	AP
U__ 140 LFS 3A ½ V XX	Price of whirlpool system incl. bath								
U__ 140 LFS 3B ½ V XX	Price of whirlpool system incl. bath incl. Multiplex Trio								

For the following whirlpool systems the technology protrudes:

Technical parts 1	Side 1-3	Side 1-5	Side 3-4	Side 4-6					
	-	-	-	-	-	-	-	-	+30
	-	-	-	-	-	-	-	-	+30
Technical parts 2	-	-	-	-	-	-	-	-	+30
	-	-	-	-	-	-	-	-	+30

Please replace __ in article number with whirlpool code.

Please replace ½ in article number with desired position of technical equipment (1 = Layout 1, 2 = Layout 2). The back jets are located at the end at which the technical equipment is installed.

For further options use the order form (see right-hand fold-out page)

Technical parts 1

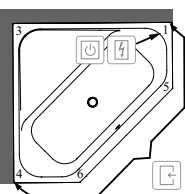

Technical parts 2

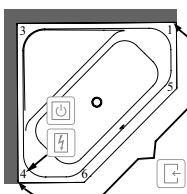

- Accessible via
- Control box
- Rim control

This symbol "○" means this option is possible

XX = Colour code to be indicated

For further information on colours, please see the page at the beginning of this section.

Further information on whirlpool systems please see page 585.

LOOP & FRIENDS OVAL Duo with oval inner form (Rectangle 1700 x 700) Acrylic

€ excl. VAT

Not included in scope of delivery: Set of bath feet is not supplied as standard.
Requires extended waste/overflow combination.

Matching sanitary ceramics: Loop & Friends

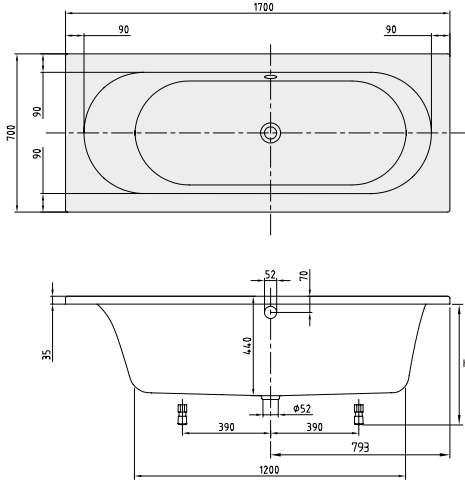

h = Installation height (min - max)	
Bath	545 - 595
Whirlpool system	585 - 625
Profibox 2.0 without system	585 - 585
Profibox 2.0 incl. System	625 - 625

Article number	Description	Size l x w	Bottom l x w	Depth	Litres incl. 1 pers	Weight (kg)	01	pcs/pal.
UBA 177 LFO 2V-XX	Loop & Friends, Duo, with oval inner form	1700 x 700	1200 x 460	440	115	21		10

Accessories for baths:

Article number	Description	Price
U99740000	Bath feet, plastic, for baths with even bottom, adjustable from 130 à 180 mm	
U90950461	Multiplex waste/overflow combination, chrome	
UCCON0475	Pipe interruptor, incl. connections	
U90600361	Multiplex Trio Outlet/overflow fitting with water inlet, chrome	
U90600461	Multiplex Trio Outlet/overflow fitting with water inlet and pipe interrupter, chrome	
U90170061	Handgrips, 1 pair = 2 grips, chrome	
U906100XX	Multifunction cushion, foam, 240 x 150 x 50 mm	

Preassembled bath options in combination with: For order form, see fold-out page on the right-hand side	only bath	Airpools		Hydropools		Combipools		Special Combipools	
		AE	AC	HE	HC	CE	CC	IP	AP
Profibox 2.0 alcove	○	○	○	○	○	○	○	○	○
Profibox 2.0 corner	○	○	○	○	○	○	○	○	○
TouchLight	○	-	-	-	-	-	-	-	-

Whirlpool Systems	Article number	Description	Airpools		Hydropools		Combipools		Special Combipools	
			AE	AC	HE	HC	CE	CC	IP	AP
	U__ 177 LFO 2A ½ V XX	Price of whirlpool system incl. bath								
	U__ 177 LFO 2B ½ V XX	Price of whirlpool system incl. bath incl. Multiplex Trio								

Please replace __ in article number with whirlpool code.
Please replace ½ in article number with desired position of technical equipment (1 = Layout 1, 2 = Layout 2). The back jets are located at the end at which the technical equipment is installed.
For further options use the order form (see right-hand fold-out page)

Technical parts 1

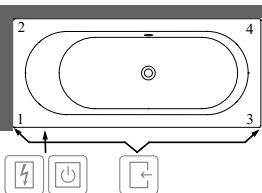

Technical parts 2

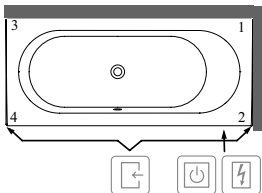

- Accessible via
- Control box
- Rim control

This symbol "○" means this option is possible

XX = Colour code to be indicated

For further information on colours, please see the page at the beginning of this section.

Further information on whirlpool systems please see page 585.

BATHS

LOOP & FRIENDS OVAL Duo with oval inner form (Rectangle 1700 x 750) Acrylic

€ excl. VAT

Not included in scope of delivery: Set of bath feet is not supplied as standard.
Requires extended waste/overflow combination.

Matching sanitary ceramics: Loop & Friends

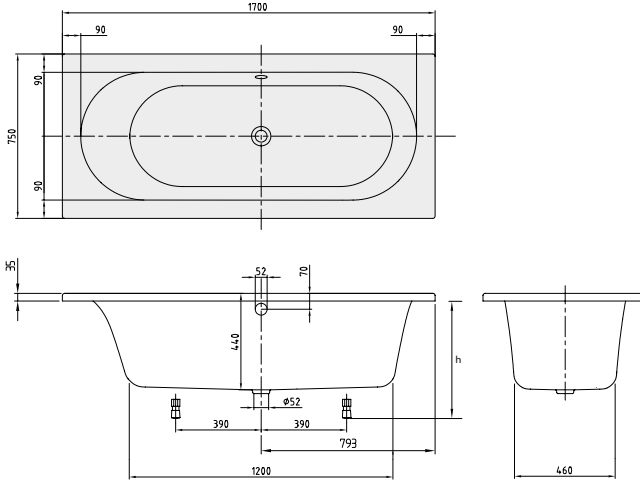

h = Installation height (min - max)	
Bath	545 - 595
Whirlpool system	585 - 625
Profibox 2.0 without system	585 - 585
Profibox 2.0 incl. System	625 - 625

Article number	Description	Size l x w	Bottom l x w	Depth	Litres incl. 1 pers	Weight (kg)	01	pcs/pal.
UBA 170 LFO 2V-XX	Loop & Friends, Duo, with oval inner form	1700 x 750	1200 x 460	440	120	21		10

Accessories for baths:

Article number	Description	Price
U99740000	Bath feet, plastic, for baths with even bottom, adjustable from 130 à 180 mm	
U90950461	Multiplex waste/overflow combination, chrome	
UCCON0475	Pipe interruptor, incl. connections	
U90600361	Multiplex Trio Outlet/overflow fitting with water inlet, chrome	
U90600461	Multiplex Trio Outlet/overflow fitting with water inlet and pipe interrupter, chrome	
U90170061	Handgrips, 1 pair = 2 grips, chrome	
U906100XX	Multifunction cushion, foam, 240 x 150 x 50 mm	

Preassembled bath options in combination with: For order form, see fold-out page on the right-hand side	only bath	Airpools		Hydropools		Combipools		Special Combipools	
		AE	AC	HE	HC	CE	CC	IP	AP
Profibox 2.0 alcove	<input type="radio"/>	<input type="radio"/>	<input type="radio"/>	<input type="radio"/>	<input type="radio"/>	<input type="radio"/>	<input type="radio"/>	<input type="radio"/>	<input type="radio"/>
Profibox 2.0 corner	<input type="radio"/>	<input type="radio"/>	<input type="radio"/>	<input type="radio"/>	<input type="radio"/>	<input type="radio"/>	<input type="radio"/>	<input type="radio"/>	<input type="radio"/>
TouchLight	<input type="radio"/>	-	-	-	-	-	-	-	-

Whirlpool Systems		Airpools		Hydropools		Combipools		Special Combipools	
Article number	Description	AE	AC	HE	HC	CE	CC	IP	AP
U__ 170 LFO 2A ½ V XX	Price of whirlpool system incl. bath								
U__ 170 LFO 2B ½ V XX	Price of whirlpool system incl. bath incl. Multiplex Trio								

Please replace __ in article number with whirlpool code.
Please replace ½ in article number with desired position of technical equipment (1 = Layout 1, 2 = Layout 2). The back jets are located at the end at which the technical equipment is installed.
For further options use the order form (see right-hand fold-out page)

Technical parts 1

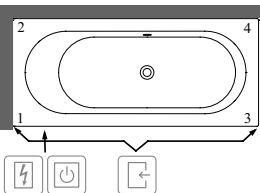

Technical parts 2

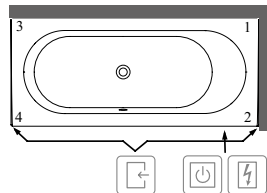

- Accessible via
- Control box
- Rim control

This symbol "O" means this option is possible

XX = Colour code to be indicated

For further information on colours, please see the page at the beginning of this section.

Further information on whirlpool systems please see page 585.

LOOP & FRIENDS OVAL Duo with oval inner form (Rectangle 1800 x 800) Acrylic

€ excl. VAT

Not included in scope of delivery: Set of bath feet is not supplied as standard.
Requires extended waste/overflow combination.
Matching sanitary ceramics: Loop & Friends

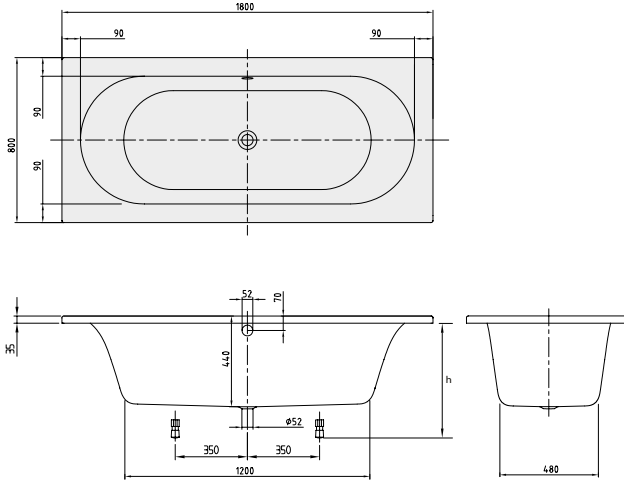

h = Installation height (min - max)	
Bath	545 - 595
Whirlpool system	585 - 625
Profibox 2.0 without system	585 - 585
Profibox 2.0 incl. System	625 - 625

Article number	Description	Size l x w	Bottom l x w	Depth	Litres incl. 1 pers	Weight (kg)	01	pcs/pal.
UBA 180 LFO 2V-XX	Loop & Friends, Duo, with oval inner form	1800 x 800	1200 x 480	440	135	23		10

Accessories for baths:

Article number	Description	Price
U99740000	Bath feet, plastic, for baths with even bottom, adjustable from 130 à 180 mm	
U90950461	Multiplex waste/overflow combination, chrome	
UCCON0475	Pipe interruptor, incl. connections	
U90600361	Multiplex Trio Outlet/overflow fitting with water inlet, chrome	
U90600461	Multiplex Trio Outlet/overflow fitting with water inlet and pipe interrupter, chrome	
U90170061	Handgrips, 1 pair = 2 grips, chrome	
U906100XX	Multifunction cushion, foam, 240 x 150 x 50 mm	

Preassembled bath options in combination with: For order form, see fold-out page on the right-hand side	only bath	Airpools		Hydropools		Combipools		Special Combipools	
		AE	AC	HE	HC	CE	CC	IP	AP
Profibox 2.0 alcove	<input type="radio"/>	<input type="radio"/>	<input type="radio"/>	<input type="radio"/>	<input type="radio"/>	<input type="radio"/>	<input type="radio"/>	<input type="radio"/>	<input type="radio"/>
Profibox 2.0 corner	<input type="radio"/>	<input type="radio"/>	<input type="radio"/>	<input type="radio"/>	<input type="radio"/>	<input type="radio"/>	<input type="radio"/>	<input type="radio"/>	<input type="radio"/>
TouchLight	<input type="radio"/>	-	-	-	-	-	-	-	-

Whirlpool Systems	Article number	Description	Airpools		Hydropools		Combipools		Special Combipools	
			AE	AC	HE	HC	CE	CC	IP	AP
	U__ 180 LFO 2A ½ V XX	Price of whirlpool system incl. bath								
	U__ 180 LFO 2B ½ V XX	Price of whirlpool system incl. bath incl. Multiplex Trio								

Please replace __ in article number with whirlpool code.
Please replace ½ in article number with desired position of technical equipment (1 = Layout 1, 2 = Layout 2). The back jets are located at the end at which the technical equipment is installed.
For further options use the order form (see right-hand fold-out page)

Technical parts 1

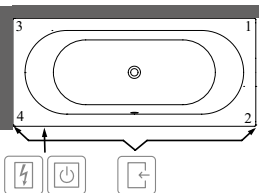

Technical parts 2

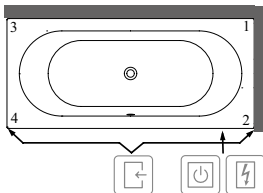

-  Accessible via
-  Control box
-  Rim control

This symbol "O" means this option is possible

XX = Colour code to be indicated

For further information on colours, please see the page at the beginning of this section.

Further information on whirlpool systems please see page 585.

LOOP & FRIENDS OVAL Duo with oval inner form (Rectangle 1900 x 900) Acrylic

€ excl. VAT

Not included in scope of delivery: Set of bath feet is not supplied as standard.
Requires extended waste/overflow combination.

Matching sanitary ceramics: Loop & Friends

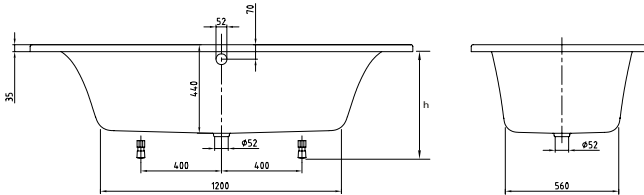
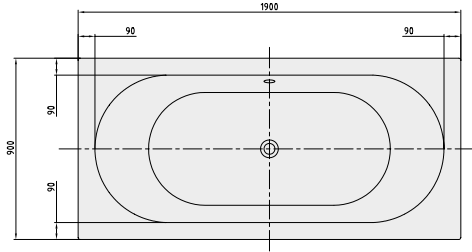

h = Installation height (min - max)	
Bath	545 - 595
Whirlpool system	585 - 625
Profibox 2.0 without system	585 - 585
Profibox 2.0 incl. System	625 - 625

Article number	Description	Size l x w	Bottom l x w	Depth	Litres incl. 1 pers	Weight (kg)	01	pcs/pal.
UBA 199 LFO 2V-XX	Loop & Friends, Duo, with oval inner form	1900 x 900	1200 x 560	440	165	25		10

Accessories for baths:

Article number	Description	Price
U99740000	Bath feet, plastic, for baths with even bottom, adjustable from 130 à 180 mm	
U90950461	Multiplex waste/overflow combination, chrome	
UCCON0475	Pipe interruptor, incl. connections	
U90600361	Multiplex Trio Outlet/overflow fitting with water inlet, chrome	
U90600461	Multiplex Trio Outlet/overflow fitting with water inlet and pipe interrupter, chrome	
U90170061	Handgrips, 1 pair = 2 grips, chrome	
U906100XX	Multifunction cushion, foam, 240 x 150 x 50 mm	

Preamsembled bath options in combination with: For order form, see fold-out page on the right-hand side	only bath	Airpools		Hydropools		Combipools		Special Combipools	
		AE	AC	HE	HC	CE	CC	IP	AP
Profibox 2.0 alcove	<input type="radio"/>	<input type="radio"/>	<input type="radio"/>	<input type="radio"/>	<input type="radio"/>	<input type="radio"/>	<input type="radio"/>	<input type="radio"/>	<input type="radio"/>
Profibox 2.0 corner	<input type="radio"/>	<input type="radio"/>	<input type="radio"/>	<input type="radio"/>	<input type="radio"/>	<input type="radio"/>	<input type="radio"/>	<input type="radio"/>	<input type="radio"/>
TouchLight	<input type="radio"/>	-	-	-	-	-	-	-	-

Whirlpool Systems	Article number	Description	Airpools		Hydropools		Combipools		Special Combipools	
			AE	AC	HE	HC	CE	CC	IP	AP
	U__ 199 LFO 2A ½ V XX	Price of whirlpool system incl. bath								
	U__ 199 LFO 2B ½ V XX	Price of whirlpool system incl. bath incl. Multiplex Trio								

Please replace __ in article number with whirlpool code.
Please replace ½ in article number with desired position of technical equipment (1 = Layout 1, 2 = Layout 2). The back jets are located at the end at which the technical equipment is installed.
For further options use the order form (see right-hand fold-out page)

Technical parts 1

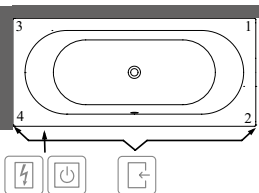

Technical parts 2

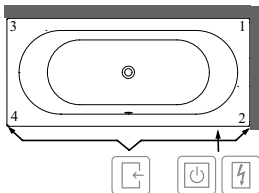

-  Accessible via
-  Control box
-  Rim control

This symbol "O" means this option is possible

XX = Colour code to be indicated

For further information on colours, please see the page at the beginning of this section.

Further information on whirlpool systems please see page 585.

LOOP & FRIENDS OVAL Duo with oval inner form (Hexagonal 1900 x 900) Acrylic

€ excl. VAT

Not included in scope of delivery: Set of bath feet is not supplied as standard.
Requires extended waste/overflow combination.

Technical information: In case of corner installation the diagonal dimension is 1344 mm.

Matching sanitary ceramics: Loop & Friends

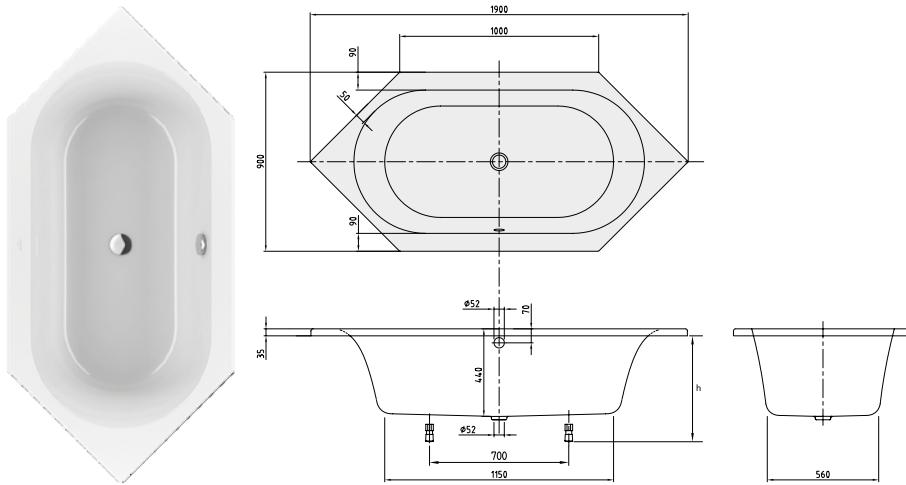

h = Installation height (min - max)	
Bath	545 - 595
Whirlpool system	585 - 625

Article number	Description	Size l x w	Bottom l x w	Depth	Litres incl. 1 pers	Weight (kg)	01	pcs/pal.
UBA 199 LFO 6V-XX	Loop & Friends, Duo, with oval inner form	1900 x 900	1150 x 560	440	135	24		15

Accessories for baths:

Article number	Description	Price
U99740000	Bath feet, plastic, for baths with even bottom, adjustable from 130 à 180 mm	
U90950461	Multiplex waste/overflow combination, chrome	
UCCON0475	Pipe interruptor, incl. connections	
U90600361	Multiplex Trio Outlet/overflow fitting with water inlet, chrome	
U90600461	Multiplex Trio Outlet/overflow fitting with water inlet and pipe interruptor, chrome	
U90170061	Handgrips, 1 pair = 2 grips, chrome	
U906100XX	Multifunction cushion, foam, 240 x 150 x 50 mm	

Preassembled bath options in combination with:		only bath	Airpools		Hydropools		Combipools		Special Combipools	
For order form, see fold-out page on the right-hand side			AE	AC	HE	HC	CE	CC	IP	AP
TouchLight		○	-	-	-	-	-	-	-	-

Whirlpool Systems		Airpools		Hydropools		Combipools		Special Combipools	
Article number	Description	AE	AC	HE	HC	CE	CC	IP	AP
U__ 199 LFO 6A ½ V XX	Price of whirlpool system incl. bath								
U__ 199 LFO 6B ½ V XX	Price of whirlpool system incl. bath incl. Multiplex Trio								

For the following whirlpool systems the technology protrudes:

Technical parts 1		-	-	-	-	-	-	-	+40
Side 3-6									
Side 4-6									+40
Technical parts 2		-	-	-	-	-	-	-	+40
Side 1-5									
Side 2-5									+40

Please replace __ in article number with whirlpool code.

Please replace ½ in article number with desired position of technical equipment (1 = Layout 1, 2 = Layout 2). The back jets are located at the end at which the technical equipment is installed.

For further options use the order form (see right-hand fold-out page)

Technical parts 1

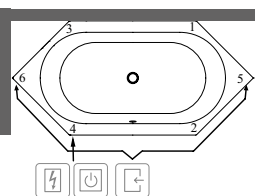

Technical parts 2

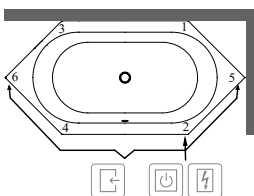

-  Accessible via
-  Control box
-  Rim control

This symbol "○" means this option is possible

XX = Colour code to be indicated

For further information on colours, please see the page at the beginning of this section.

Further information on whirlpool systems please see page 585.

BATHS

LOOP & FRIENDS OVAL Duo with oval inner form (Oval 1800 x 800) Acrylic

€ excl. VAT

Not included in scope of delivery: Set of bath feet is not supplied as standard.
Requires extended waste/overflow combination.

Matching sanitary ceramics: Loop & Friends

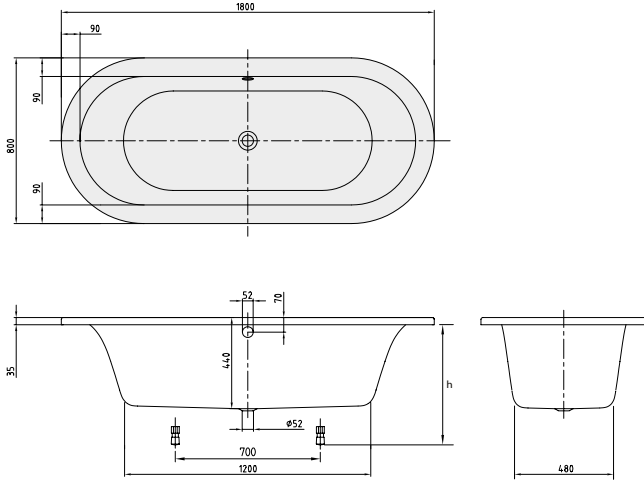

h = Installation height (min - max)	
Bath	545 - 595
Whirlpool system	585 - 625

Article number	Description	Size l x w	Bottom l x w	Depth	Litres incl. 1 pers	Weight (kg)	01	pcs/pal.
UBA 180 LFO 7V-XX	Loop & Friends, Duo, with oval inner form	1800 x 800	1200 x 480	440	135	23		12

Accessories for baths:

Article number	Description	Price
U99740000	Bath feet, plastic, for baths with even bottom, adjustable from 130 à 180 mm	
U90950461	Multiplex waste/overflow combination, chrome	
UCCON0475	Pipe interruptor, incl. connections	
U90600361	Multiplex Trio Outlet/overflow fitting with water inlet, chrome	
U90600461	Multiplex Trio Outlet/overflow fitting with water inlet and pipe interrupter, chrome	
U90170061	Handgrips, 1 pair = 2 grips, chrome	
U906100XX	Multifunction cushion, foam, 240 x 150 x 50 mm	

Preassembled bath options in combination with: For order form, see fold-out page on the right-hand side	only bath	Airpools		Hydropools		Combipools		Special Combipools	
		AE	AC	HE	HC	CE	CC	IP	AP
TouchLight	○	-	-	-	-	-	-	-	-

Whirlpool Systems		Airpools		Hydropools		Combipools		Special Combipools	
Article number	Description	AE	AC	HE	HC	CE	CC	IP	AP
U__ 180 LFO 7A ½ V XX	Price of whirlpool system incl. bath								
U__ 180 LFO 7B ½ V XX	Price of whirlpool system incl. bath incl. Multiplex Trio								

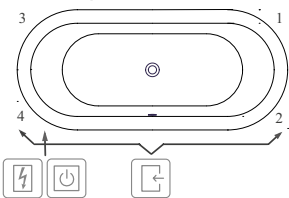

Please replace __ in article number with whirlpool code.
Please replace ½ in article number with desired position of technical equipment (1 = Layout 1, 2 = Layout 2). The back jets are located at the end at which the technical equipment is installed.
For further options use the order form (see right-hand fold-out page)

Technical parts 1

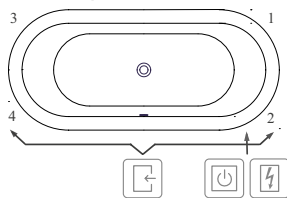

Technical parts 2



-  Accessible via
-  Control box
-  Rim control

This symbol "○" means this option is possible

XX = Colour code to be indicated

For further information on colours, please see the page at the beginning of this section.

Further information on whirlpool systems please see page 585.

LOOP & FRIENDS OVAL Duo With oval outer and inner form (Free-standing 1800 x 800) Acrylic

€ excl. VAT

Included in scope of delivery: Matching outlet and overflow (Chrome) is supplied as standard.
Technical information: Whirlpool systems available on request.
Matching sanitary ceramics: Loop & Friends

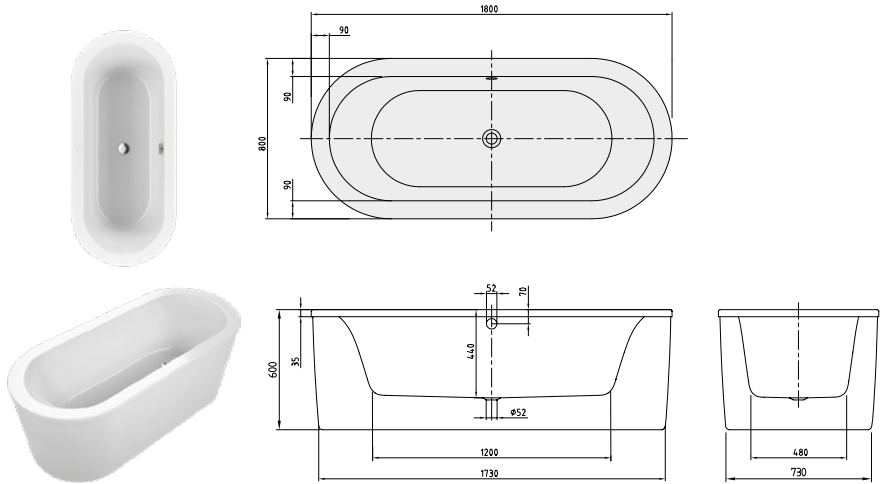

Article number	Description	Size l x w	Bottom l x w	Depth	Litres incl. 1 pers	Weight (kg)	01	pcs/pal.
UBA 180 LFO 7PDV-XX	Loop & Friends, Duo, freestanding, incl. panel in the same colour as the bath (Acrylic), incl. waste/overflow chrome-plated, With oval outer and inner form	1800 x 800	1200 x 480	440	135	43		1

Accessories for baths:

Article number	Description	Price
UCCON0475	Pipe interruptor, incl. connections	
U90600361	Multiplex Trio Outlet/overflow fitting with water inlet, chrome	
U90600461	Multiplex Trio Outlet/overflow fitting with water inlet and pipe interrupter, chrome	
U90170061	Handgrips, 1 pair = 2 grips, chrome	
U906100XX	Multifunction cushion, foam, 240 x 150 x 50 mm	

Preassembled bath options in combination with:

For order form, see fold-out page on the right-hand side	Price
TouchLight	

XX = Colour code to be indicated
 For further information on colours, please see the page at the beginning of this section.
 Further information on whirlpool systems please see page 585.

BATHS

LOOP & FRIENDS OVAL Duo With oval outer and inner form (Free-standing 1800 x 800) Acrylic, Colour on Demand

€ excl. VAT

Included in scope of delivery: Matching outlet and overflow (Chrome) is supplied as standard.
Technical information: Whirlpool systems available on request.
Matching sanitary ceramics: Loop & Friends

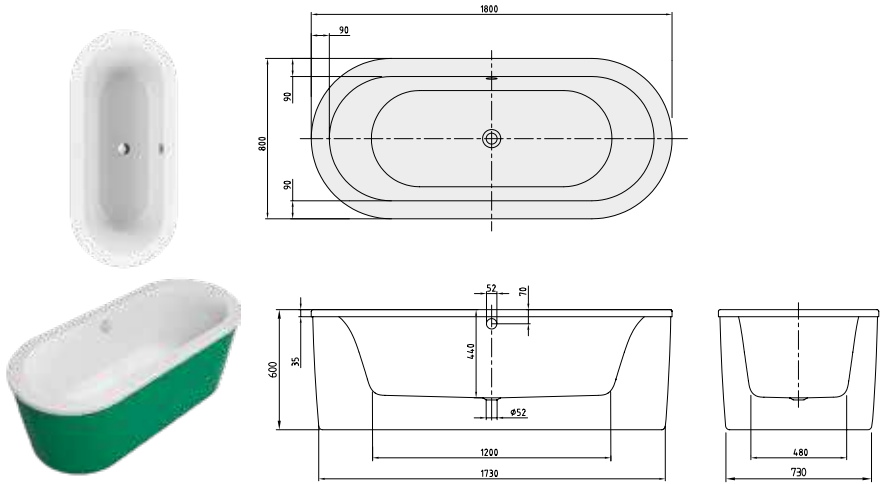

Article number	Description	Size l x w	Bottom l x w	Depth	Litres incl. 1 pers	Weight (kg)	01	pcs/pal.
UBA 180 LFO 7PDBCX-XX	Loop & Friends, Duo, freestanding, incl. panel in Colour on Demand (Acrylic), incl. waste/overflow chrome-plated, With oval outer and inner form	1800 x 800	1200 x 480	440	135	43		1

Accessories for baths:

Article number	Description	Price
UCCON0475	Pipe interruptor, incl. connections	
U90600361	Multiplex Trio Outlet/overflow fitting with water inlet, chrome	
U90600461	Multiplex Trio Outlet/overflow fitting with water inlet and pipe interrupter, chrome	
U90170061	Handgrips, 1 pair = 2 grips, chrome	
U906100XX	Multifunction cushion, foam, 240 x 150 x 50 mm	

Preassembled bath options in combination with:

For order form, see fold-out page on the right-hand side	Price
TouchLight	

Made-to-order production - Colour on Demand: 3 week delivery period. Please make sure to use the **order form** that you will find immediately after the chapter on baths on page 578-579, so that we can complete the order for you.

XX = Colour code to be indicated
 For further information on colours, please see the page at the beginning of this section.
 Further information on whirlpool systems please see page 585.

LOOP & FRIENDS OVAL with oval inner form (Special shape 1750 x 1350) Acrylic

€ excl. VAT

Not included in scope of delivery: Set of bath feet is not supplied as standard.
Requires extended waste/overflow combination.

Matching sanitary ceramics: Loop & Friends

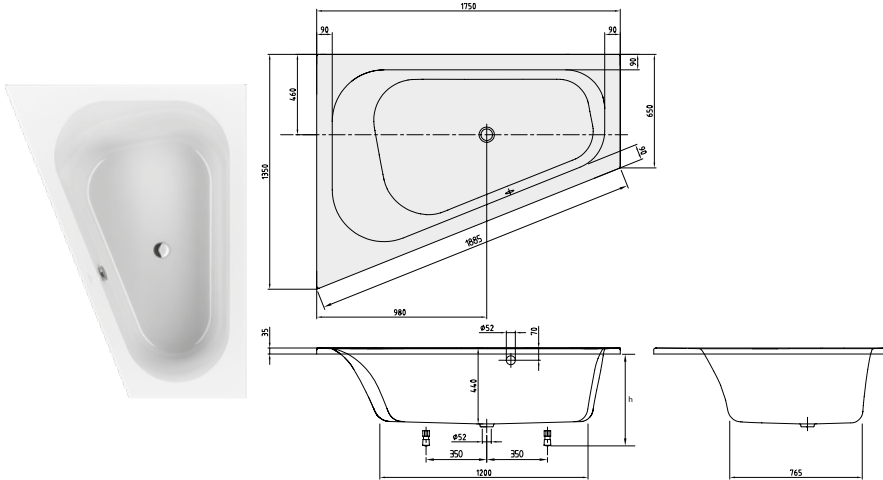

h = Installation height (min - max)	
Bath	545 - 595
Whirlpool system	585 - 625

Article number	Description	Size l x w	Bottom l x w	Depth	Litres incl. 1 pers	Weight (kg)	01	pcs/pal.
UBA 175 LFO 9LIV-XX	Loop & Friends, left hand version, with oval inner form	1750 x 1350	1200 x 765	440	205	32		8

Accessories for baths:

Article number	Description	Price
U99740000	Bath feet, plastic, for baths with even bottom, adjustable from 130 à 180 mm	
U90950461	Multiplex waste/overflow combination, chrome	
UCCON0475	Pipe interruptor, incl. connections	
U90600361	Multiplex Trio Outlet/overflow fitting with water inlet, chrome	
U90600461	Multiplex Trio Outlet/overflow fitting with water inlet and pipe interrupter, chrome	
U90170061	Handgrips, 1 pair = 2 grips, chrome	
U906100XX	Multifunction cushion, foam, 240 x 150 x 50 mm	

Preassembled bath options in combination with: For order form, see fold-out page on the right-hand side	only bath	Airpools		Hydropools		Combipools		Special Combipools	
		AE	AC	HE	HC	CE	CC	IP	AP
TouchLight	○	-	-	-	-	-	-	-	-

Whirlpool Systems		Airpools		Hydropools		Combipools		Special Combipools	
Article number	Description	AE	AC	HE	HC	CE	CC	IP	AP
U __ 175 LFO LA 1 V XX	Price of whirlpool system incl. bath								
U __ 175 LFO LB 1 V XX	Price of whirlpool system incl. bath incl. Multiplex Trio								

Please replace __ in article number with whirlpool code.

For further options use the order form (see right-hand fold-out page)

Technical parts 1

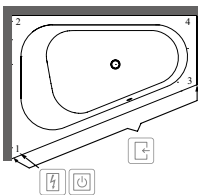

This symbol "○" means this option is possible

XX = Colour code to be indicated

For further information on colours, please see the page at the beginning of this section.

Further information on whirlpool systems please see page 585.

BATHS

LOOP & FRIENDS OVAL with oval inner form (Special shape 1750 x 1350) Acrylic

€ excl. VAT

Not included in scope of delivery: Set of bath feet is not supplied as standard.
Requires extended waste/overflow combination.
Matching sanitary ceramics: Loop & Friends

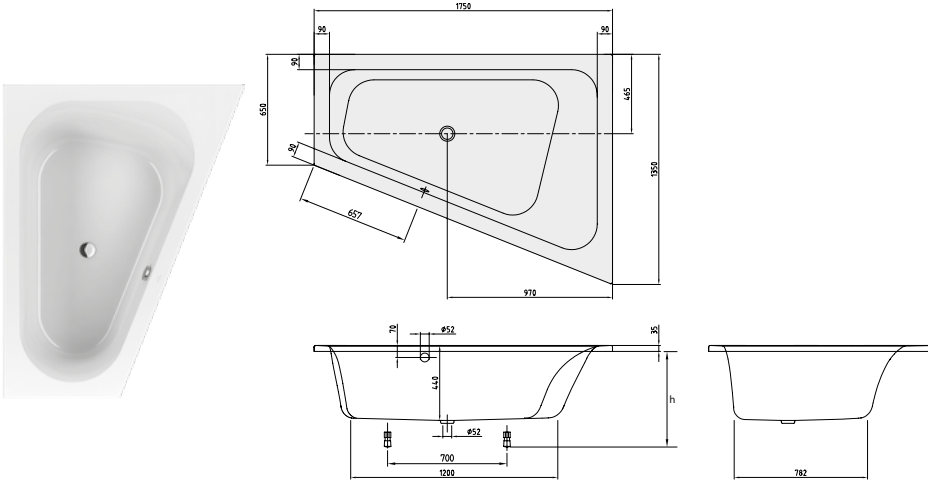

h = Installation height (min - max)	
Bath	545 - 595
Whirlpool system	585 - 625

Article number	Description	Size l x w	Bottom l x w	Depth	Litres incl. 1 pers	Weight (kg)	01	pcs/pal.
UBA 175 LFO 9REV-XX	Loop & Friends, right hand version, with oval inner form	1750 x 1350	1200 x 765	440	205	32		8

Accessories for baths:

Article number	Description	Price
U99740000	Bath feet, plastic, for baths with even bottom, adjustable from 130 à 180 mm	
U90950461	Multiplex waste/overflow combination, chrome	
UCCON0475	Pipe interruptor, incl. connections	
U90600361	Multiplex Trio Outlet/overflow fitting with water inlet, chrome	
U90600461	Multiplex Trio Outlet/overflow fitting with water inlet and pipe interrupter, chrome	
U90170061	Handgrips, 1 pair = 2 grips, chrome	
U906100XX	Multifunction cushion, foam, 240 x 150 x 50 mm	

Preassembled bath options in combination with:

For order form, see fold-out page on the right-hand side	only bath	Airpools		Hydropools		Combipools		Special Combipools	
		AE	AC	HE	HC	CE	CC	IP	AP
TouchLight	○	-	-	-	-	-	-	-	-

Whirlpool Systems

Article number	Description	Airpools		Hydropools		Combipools		Special Combipools	
		AE	AC	HE	HC	CE	CC	IP	AP
U _ 175 LFO RA 1 V XX	Price of whirlpool system incl. bath								
U _ 175 LFO RB 1 V XX	Price of whirlpool system incl. bath incl. Multiplex Trio								

Please replace _ _ in article number with whirlpool code.

For further options use the order form (see right-hand fold-out page)

Technical parts 1

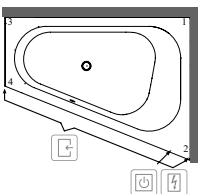

This symbol "○" means this option is possible

XX = Colour code to be indicated

For further information on colours, please see the page at the beginning of this section.

Further information on whirlpool systems please see page 585.

LOOP & FRIENDS OVAL Duo with oval inner form (Corner 1400 x 1400) Acrylic

€ excl. VAT

Not included in scope of delivery:

Set of bath feet is not supplied as standard.
 Requires extended waste/overflow combination.
 Panel (optionally available, is always pre-installed at the factory). Please note: The panel cannot be retro-fitted.
 Loop & Friends

Matching sanitary ceramics:

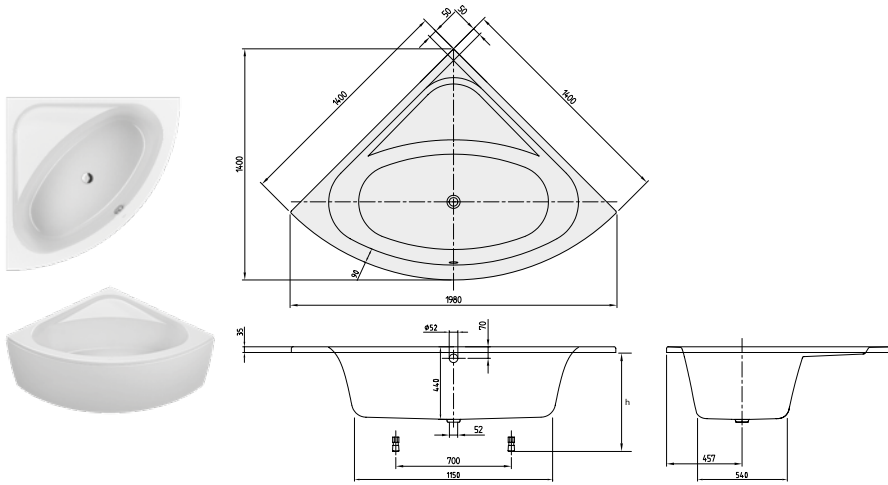

h = Installation height (min - max)	
Bath	545 - 595
Bath with panel	585 - 685
Whirlpool system	585 - 625

Article number	Description	Size l x w	Bottom l x w	Depth	Litres incl. 1 pers	Weight (kg)	01	pcs/pat.
UBA 140 LFO 3V-XX	Loop & Friends, Duo, with oval inner form	1400 x 1400	1150 x 560	440	145	26		8

Accessories for baths:

Article number	Description	Price
U99740000	Bath feet, plastic, for baths with even bottom, adjustable from 130 à 180 mm	
U90950461	Multiplex waste/overflow combination, chrome	
UCCON0475	Pipe interruptor, incl. connections	
U90600361	Multiplex Trio Outlet/overflow fitting with water inlet, chrome	
U90600461	Multiplex Trio Outlet/overflow fitting with water inlet and pipe interruptor, chrome	
U90170061	Handgrips, 1 pair = 2 grips, chrome	
U906100XX	Multifunction cushion, foam, 240 x 150 x 50 mm	

Preassembled bath options in combination with: For order form, see fold-out page on the right-hand side	only bath	Airpools		Hydropools		Combipools		Special Combipools	
		AE	AC	HE	HC	CE	CC	IP	AP
Separate panel	<input type="radio"/>	<input type="radio"/>	<input type="radio"/>	<input type="radio"/>	<input type="radio"/>	<input type="radio"/>	<input type="radio"/>	<input type="radio"/>	<input type="radio"/>
TouchLight	<input type="radio"/>	-	-	-	-	-	-	-	-

Whirlpool Systems		Airpools		Hydropools		Combipools		Special Combipools	
Article number	Description	AE	AC	HE	HC	CE	CC	IP	AP
U_ 140 LFO 3A ½ V XX	Price of whirlpool system incl. bath								
U_ 140 LFO 3B ½ V XX	Price of whirlpool system incl. bath incl. Multiplex Trio								

For the following whirlpool systems the technology protrudes:

Technical parts 1									
	Side 1-3	-	-	-	-	-	-	-	+30
	Side 1-4	-	-	-	-	-	-	-	+30
Technical parts 2	Side 1-4	-	-	-	-	-	-	-	+30
	Side 3-4	-	-	-	-	-	-	-	+30

Please replace _ in article number with whirlpool code.

Please replace ½ in article number with desired position of technical equipment (1 = Layout 1, 2 = Layout 2). The back jets are located at the end at which the technical equipment is installed.

For further options use the order form (see right-hand fold-out page)

Technical parts 1

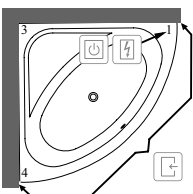

Technical parts 2

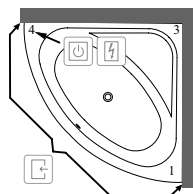

-  Accessible via
-  Control box
-  Rim control

This symbol "O" means this option is possible

XX = Colour code to be indicated

For further information on colours, please see the page at the beginning of this section.

Further information on whirlpool systems please see page 585.

BATHS

MY ART Solo (Rectangle 1700 x 750) Quarryl®

€ excl. VAT

Included in scope of delivery:

Set of bath feet is supplied as standard (self-adhesive), adjustable from 130 à 180 mm.

Not included in scope of delivery:

Requires extended waste/overflow combination.

Technical information:

Overflow hole possible in one of 3 different positions. Holesaw (for drilling the overflow hole) included. Suitable for wall outlet and pillar taps (not possible to install taps in bath rim).

Whirlpool systems available on request.

United available for whirlpool systems on request

Matching sanitary ceramics:

Loop & Friends

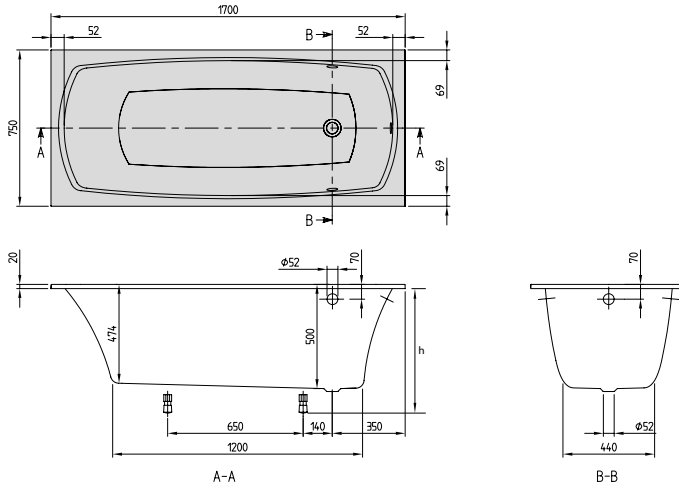

h = Installation height (min - max)	
Bath	640 - 690

Article number	Description	Size l x w	Bottom l x w	Depth	Litres incl. 1 pers	Weight (kg)	01	pcs/pal.
UBQ 170 MYA 2V-XX	My Art, Solo	1700 x 750	1200 x 440	500	190	46,8		8

Accessories for baths:

Article number	Description	Price
U90950461	Multiplex waste/overflow combination, chrome	
UCCON0475	Pipe interruptor, incl. connections	
U90600361	Multiplex Trio Outlet/overflow fitting with water inlet, chrome	
U90600461	Multiplex Trio Outlet/overflow fitting with water inlet and pipe interruptor, chrome	
U90170061	Handgrips, 1 pair = 2 grips, chrome	
U906100XX	Multifunction cushion, foam, 240 x 150 x 50 mm	

Preassembled bath options in combination with:

For order form, see fold-out page on the right-hand side

	Price
UNITED Free-standing	
UNITED Corner	
TouchLight	

XX = Colour code to be indicated
 For further information on colours, please see the page at the beginning of this section.
 Further information on whirlpool systems please see page 585.

MY ART Duo (Rectangle 1800 x 800) Quarryl®

€ excl. VAT

Included in scope of delivery: Set of bath feet is supplied as standard (self-adhesive), adjustable from 130 à 180 mm.
Not included in scope of delivery: Requires extended waste/overflow combination.
Technical information: Suitable for wall outlet and pillar taps (not possible to install taps in bath rim).
Whirlpool systems available on request.
 United available for whirlpool systems on request
 Loop & Friends

Matching sanitary ceramics:

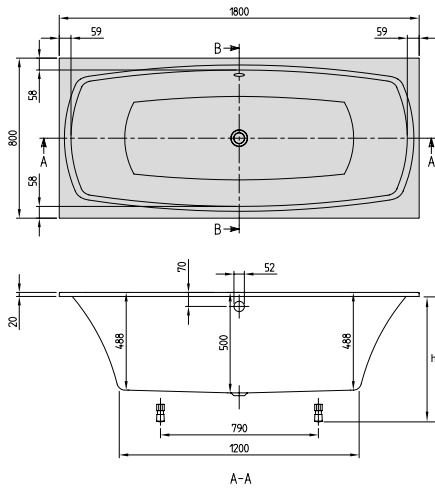

BATHS

h = Installation height (min - max)	
Bath	640 - 690

Article number	Description	Size l x w	Bottom l x w	Depth	Litres incl. 1 pers	Weight (kg)	01	pcs/pal.
UBQ 180 MYA 2V-XX	My Art, Duo	1800 x 800	1200 x 520	500	210	50,4		8

Accessories for baths:

Article number	Description	Price
U90950461	Multiplex waste/overflow combination, chrome	
UCCON0475	Pipe interruptor, incl. connections	
U90600361	Multiplex Trio Outlet/overflow fitting with water inlet, chrome	
U90600461	Multiplex Trio Outlet/overflow fitting with water inlet and pipe interrupter, chrome	
U90170061	Handgrips, 1 pair = 2 grips, chrome	
U906100XX	Multifunction cushion, foam, 240 x 150 x 50 mm	

Preassembled bath options in combination with:

For order form, see fold-out page on the right-hand side

	Price
UNITED Free-standing	
UNITED Corner	
TouchLight	

XX = Colour code to be indicated
 For further information on colours, please see the page at the beginning of this section.
 Further information on whirlpool systems please see page 585.

NEXUS Duo (Oval 1771 x 771) Quarryl®

€ excl. VAT

Included in scope of delivery: Set of bath feet is supplied as standard (self-adhesive), adjustable from 130 à 180 mm.
Not included in scope of delivery: Requires extended waste/overflow combination.
Technical information: Built-in height 560 mm, measured from floor to underside of the bathrim.
Whirlpool systems available on request.

BATHS

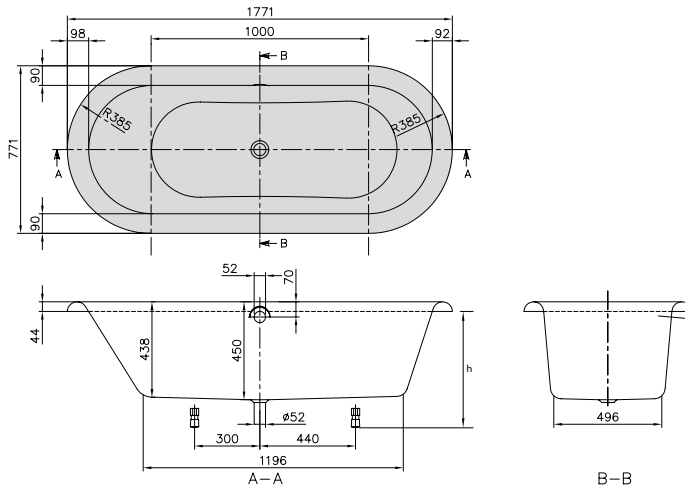

h = Installation height (min - max)	
Bath	560 - 610

Article number	Description	Size l x w	Bottom l x w	Depth	Litres incl. 1 pers	Weight (kg)	01	pcs/pal.
UBQ 180 NEU 7V-XX	Nexus	1771 x 771	1200 x 500	450	160	41		8

Accessories for baths:

Article number	Description	Price
U90950461	Multiplex waste/overflow combination, chrome	
UCCON0475	Pipe interruptor, incl. connections	
U90600361	Multiplex Trio Outlet/overflow fitting with water inlet, chrome	
U90600461	Multiplex Trio Outlet/overflow fitting with water inlet and pipe interruptor, chrome	
U90170061	Handgrips, 1 pair = 2 grips, chrome	
U906100XX	Multifunction cushion, foam, 240 x 150 x 50 mm	

Preassembled bath options in combination with:

For order form, see fold-out page on the right-hand side

TouchLight	Price

XX = Colour code to be indicated
 For further information on colours, please see the page at the beginning of this section.
 Further information on whirlpool systems please see page 585.

OBERON Solo (Rectangle 1600 x 750) Quarryl®

€ excl. VAT

Included in scope of delivery:

Set of bath feet is supplied as standard (self-adhesive), adjustable from 130 à 180 mm.

Not included in scope of delivery:

Requires extended waste/overflow combination.

Technical information:

Overflow hole possible in one of 3 different positions. Holesaw (for drilling the overflow hole) included. In combination with a whirlpool, the overflow is mounted on the side where the technical parts are also accessible.

The whirlpool system IP (Special Combipool Invisible) for baths in color Stone White (RW) will be delivered with Stone White (RW) colored jets. For all other pools in the color RW, the jets remain in Chrome.

Price for whirlpool system in the colour Stone White (RW) on request.

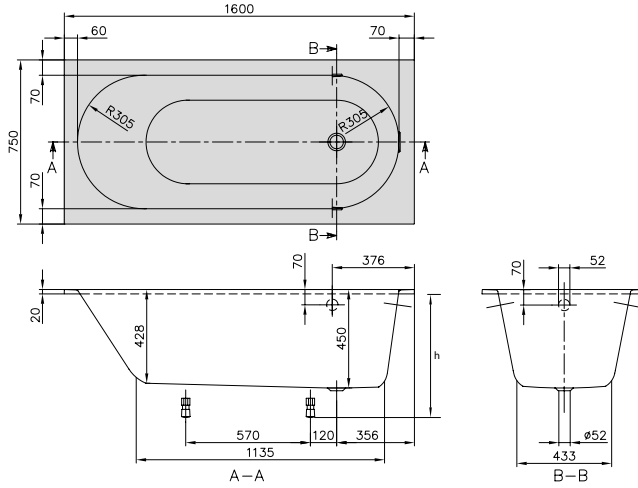

Quaryl®

h = Installation height (min - max)	
Bath	585 - 635
Whirlpool system	610 - 650
Profibox 2.0 without system	585 - 585
Profibox 2.0 incl. System	625 - 625

Article number	Description	Size l x w	Bottom l x w	Depth	Litres incl. 1 pers	Weight (kg)	01	RW	pcs/pal.
UBQ 160 OBE 2V-XX	Oberon	1600 x 750	1140 x 430	450	125	35,4			8

Accessories for baths:

Article number	Description	Price
U90950461	Multiplex waste/overflow combination, chrome	
UCCON0475	Pipe interruptor, incl. connections	
U90600361	Multiplex Trio Outlet/overflow fitting with water inlet, chrome	
U90600461	Multiplex Trio Outlet/overflow fitting with water inlet and pipe interruptor, chrome	
U90170061	Handgrips, 1 pair = 2 grips, chrome	
U906100XX	Multifunction cushion, foam, 240 x 150 x 50 mm	

Preassembled bath options in combination with: For order form, see fold-out page on the right-hand side	only bath	Airpools		Hydropools		Combipools		Special Combipools	
		AE	AC	HE	HC	CE	CC	IP	AP
Profibox 2.0 alcove	○	○	○	○	○	○	○	○	-
Profibox 2.0 corner	○	○	○	○	○	○	○	○	-
TouchLight	○	-	-	-	-	-	-	-	-

Whirlpool Systems	Article number	Description	Airpools		Hydropools		Combipools		Special Combipools	
			AE	AC	HE	HC	CE	CC	IP	AP
	U__160 OBE 2A ½ V XX	Price of whirlpool system incl. bath								
	U__160 OBE 2B ½ V XX	Price of whirlpool system incl. bath incl. Multiplex Trio								

Please replace __ in article number with whirlpool code.

Please replace ½ in article number with desired position of technical equipment (1 = Layout 1, 2 = Layout 2). The back jets are located at the end at which the technical equipment is installed.

For further options use the order form (see right-hand fold-out page)

Technical parts 1

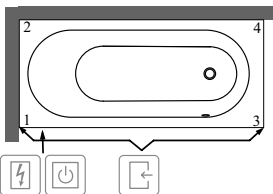

Technical parts 2

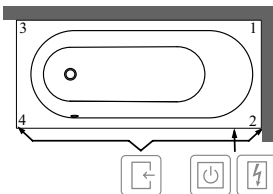

- Accessible via
- Control box
- Rim control

This symbol "○" means this option is possible

XX = Colour code to be indicated

For further information on colours, please see the page at the beginning of this section.

Further information on whirlpool systems please see page 585.

OBERON Solo (Rectangle 1700 x 700) Quarry®

€ excl. VAT

Included in scope of delivery:
Not included in scope of delivery:
Technical information:

Set of bath feet is supplied as standard (self-adhesive), adjustable from 130 à 180 mm.
 Requires extended waste/overflow combination.
 Overflow hole possible in one of 3 different positions. Holesaw (for drilling the overflow hole) included. In combination with a whirlpool, the overflow is mounted on the side where the technical parts are also accessible.
 The whirlpool system IP (Special Combipool Invisible) for baths in color Stone White (RW) will be delivered with Stone White (RW) colored jets. For all other pools in the color RW, the jets remain in Chrome.
Price for whirlpool system in the colour Stone White (RW) on request.

BATHS

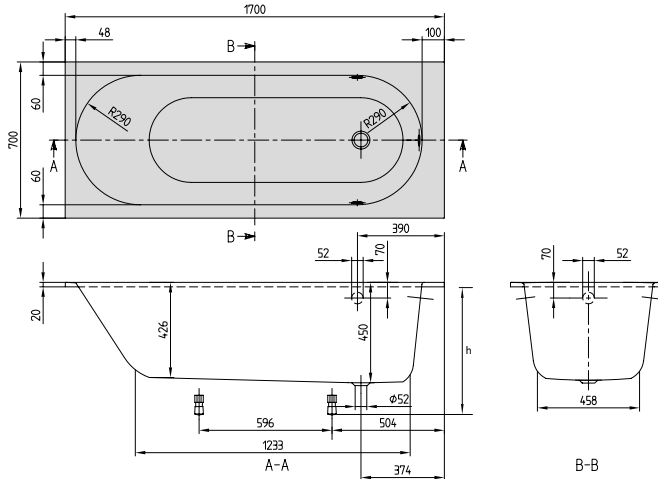

Quarry®

h = Installation height (min - max)	
Bath	585 - 635
Whirlpool system	610 - 650
UNITED without system	610 - 610
UNITED incl. System	610 - 610
Profibox 2.0 without system	585 - 585
Profibox 2.0 incl. System	625 - 625

Article number	Description	Size l x w	Bottom l x w	Depth	Litres incl. 1 pers	Weight (kg)	01	RW	pcs/pal.
UBQ 177 OBE 2V-XX	Oberon	1700 x 700	1230 x 460	450	135	39,2			8

Accessories for baths:

Article number	Description	Price
U90950461	Multiplex waste/overflow combination, chrome	
UCCON0475	Pipe interruptor, incl. connections	
U90600361	Multiplex Trio Outlet/overflow fitting with water inlet, chrome	
U90600461	Multiplex Trio Outlet/overflow fitting with water inlet and pipe interruptor, chrome	
U90170061	Handgrips, 1 pair = 2 grips, chrome	
U906100XX	Multifunction cushion, foam, 240 x 150 x 50 mm	

Preassembled bath options in combination with: For order form, see fold-out page on the right-hand side	only bath	Airpools		Hydropools		Combipools		Special Combipools	
		AE	AC	HE	HC	CE	CC	IP	AP
UNITED Free-standing	○	-	-	-	-	-	-	-	-
UNITED Corner	○	○	○	○	-	○	-	-	-
Profibox 2.0 alcove	○	○	○	○	○	○	○	-	-
Profibox 2.0 corner	○	○	○	○	○	○	○	-	-
TouchLight	○	-	-	-	-	-	-	-	-

Whirlpool Systems		Airpools		Hydropools		Combipools		Special Combipools	
Article number	Description	AE	AC	HE	HC	CE	CC	IP	AP
U__ 177 OBE 2A ½ V XX	Price of whirlpool system incl. bath								
U__ 177 OBE 2B ½ V XX	Price of whirlpool system incl. bath incl. Multiplex Trio								

For the following whirlpool systems the technology protrudes:

Technical parts 1	Side 1-3	-	-	-	-	-	-	+15	+30
	Side 2-4	-	-	-	-	-	-	+15	+30
Technical parts 2	Side 1-3	-	-	-	-	-	-	+15	+30
	Side 2-4	-	-	-	-	-	-	+15	+30

Please replace __ in article number with whirlpool code.

Please replace ½ in article number with desired position of technical equipment (1 = Layout 1, 2 = Layout 2). The back jets are located at the end at which the technical equipment is installed.

For further options use the order form (see right-hand fold-out page)

Technical parts 1

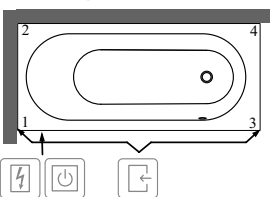

Technical parts 2

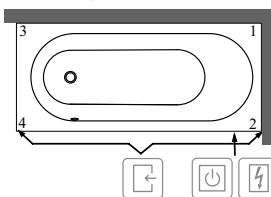

- Accessible via
- Control box
- Rim control

This symbol "○" means this option is possible

XX = Colour code to be indicated

For further information on colours, please see the page at the beginning of this section.

Further information on whirlpool systems please see page 585.

OBERON Solo (Rectangle 1800 x 800) Quarryl®

€ excl. VAT

Included in scope of delivery:

Set of bath feet is supplied as standard (self-adhesive), adjustable from 130 à 180 mm.

Not included in scope of delivery:

Requires extended waste/overflow combination.

Technical information:

Overflow hole possible in one of 3 different positions. Holesaw (for drilling the overflow hole) included. In combination with a whirlpool, the overflow is mounted on the side where the technical parts are also accessible. The whirlpool system IP (Special Combipool Invisible) for baths in color Stone White (RW) will be delivered with Stone White (RW) colored jets. For all other pools in the color RW, the jets remain in Chrome.

Price for whirlpool system in the colour Stone White (RW) on request.

BATHS

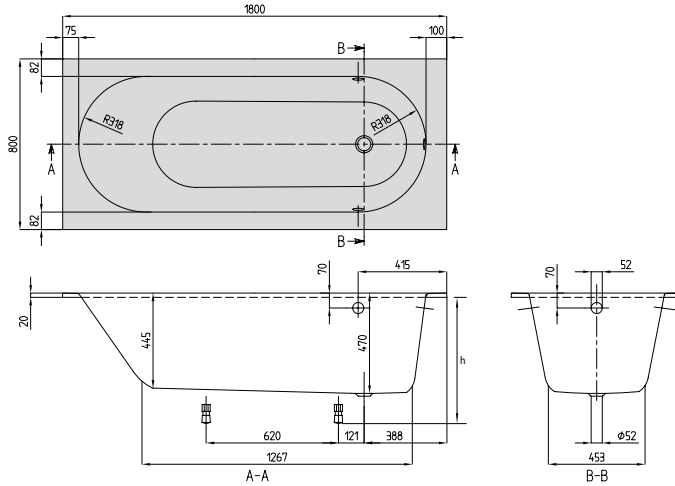

Quarryl®

h = Installation height (min - max)	
Bath	605 - 655
Whirlpool system	630 - 670
UNITED without system	610 - 610
UNITED incl. System	610 - 610
Profibox 2.0 without system	585 - 585
Profibox 2.0 incl. System	625 - 625

Article number	Description	Size l x w	Bottom l x w	Depth	Litres incl. 1 pers	Weight (kg)	01	RW	pcs/pal.
UBQ 180 OBE 2V-XX	Oberon	1800 x 800	1270 x 460	470	175	43,2			8

Accessories for baths:

Article number	Description	Price
U90950461	Multiplex waste/overflow combination, chrome	
UCCON0475	Pipe interruptor, incl. connections	
U90600361	Multiplex Trio Outlet/overflow fitting with water inlet, chrome	
U90600461	Multiplex Trio Outlet/overflow fitting with water inlet and pipe interruptor, chrome	
U90170061	Handgrips, 1 pair = 2 grips, chrome	
U906100XX	Multifunction cushion, foam, 240 x 150 x 50 mm	

Preassembled bath options in combination with: For order form, see fold-out page on the right-hand side	only bath	Airpools		Hydropools		Combipools		Special Combipools	
		AE	AC	HE	HC	CE	CC	IP	AP
UNITED Free-standing	○	-	-	-	-	-	-	-	-
UNITED Corner	○	○	○	○	○	○	○	○	○
Profibox 2.0 alcove	○	○	○	○	○	○	○	○	○
Profibox 2.0 corner	○	○	○	○	○	○	○	○	○
TouchLight	○	-	-	-	-	-	-	-	-

Whirlpool Systems		Airpools		Hydropools		Combipools		Special Combipools	
Article number	Description	AE	AC	HE	HC	CE	CC	IP	AP
U__ 180 OBE 2A ½ V XX	Price of whirlpool system incl. bath								
U__ 180 OBE 2B ½ V XX	Price of whirlpool system incl. bath incl. Multiplex Trio								

Please replace __ in article number with whirlpool code.

Please replace ½ in article number with desired position of technical equipment (1 = Layout 1, 2 = Layout 2). The back jets are located at the end at which the technical equipment is installed.

For further options use the order form (see right-hand fold-out page)

Technical parts 1

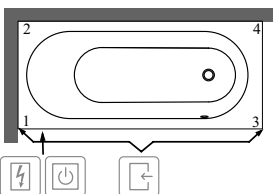

Technical parts 2

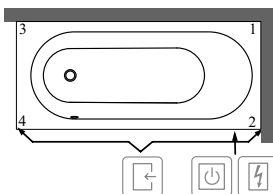

- Accessible via
- Control box
- Rim control

This symbol "○" means this option is possible

XX = Colour code to be indicated

For further information on colours, please see the page at the beginning of this section.

Further information on whirlpool systems please see page 585.

OBERON Duo (Rectangle 1900 x 900) Quarryl®

€ excl. VAT

Included in scope of delivery:

Set of bath feet is supplied as standard (self-adhesive), adjustable from 130 à 180 mm.

Not included in scope of delivery:

Requires extended waste/overflow combination.

Technical information:

The whirlpool system IP (Special Combipool Invisible) for baths in color Stone White (RW) will be delivered with Stone White (RW) colored jets. For all other pools in the color RW, the jets remain in Chrome.

Price for whirlpool system in the colour Stone White (RW) on request.

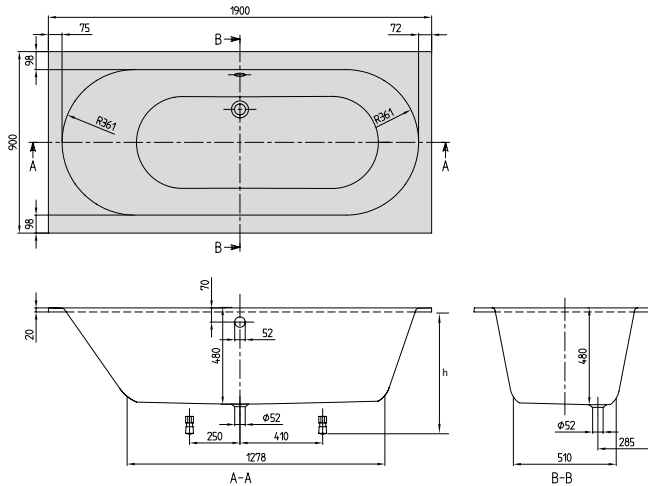

Quarryl®

h = Installation height (min - max)	
Bath	615 - 665
Whirlpool system	640 - 670
UNITED without system	610 - 610
UNITED incl. System	610 - 610
Profibox 2.0 without system	585 - 585
Profibox 2.0 incl. System	625 - 625

Article number	Description	Size l x w	Bottom l x w	Depth	Litres incl. 1 pers	Weight (kg)	01	RW	pcs/pal.
UBQ 199 OBE 2V-XX	Oberon	1900 x 900	1280 x 510	480	218	46			8

Accessories for baths:

Article number	Description	Price
U90950461	Multiplex waste/overflow combination, chrome	
UCCON0475	Pipe interruptor, incl. connections	
U90600361	Multiplex Trio Outlet/overflow fitting with water inlet, chrome	
U90600461	Multiplex Trio Outlet/overflow fitting with water inlet and pipe interruptor, chrome	
U90170061	Handgrips, 1 pair = 2 grips, chrome	
U906100XX	Multifunction cushion, foam, 240 x 150 x 50 mm	

Preassembled bath options in combination with: For order form, see fold-out page on the right-hand side	only bath	Airpools		Hydropools		Combipools		Special Combipools	
		AE	AC	HE	HC	CE	CC	IP	AP
UNITED Free-standing	○	-	-	-	-	-	-	-	-
UNITED Corner	○	○	○	○	○	○	○	○	○
Profibox 2.0 alcove	○	○	○	○	○	○	○	○	○
Profibox 2.0 corner	○	○	○	○	○	○	○	○	○
TouchLight	○	-	-	-	-	-	-	-	-

Whirlpool Systems		Airpools		Hydropools		Combipools		Special Combipools	
Article number	Description	AE	AC	HE	HC	CE	CC	IP	AP
U__ 199 OBE 2A ½ V XX	Price of whirlpool system incl. bath								
U__ 199 OBE 2B ½ V XX	Price of whirlpool system incl. bath incl. Multiplex Trio								

Please replace __ in article number with whirlpool code.

Please replace ½ in article number with desired position of technical equipment (1 = Layout 1, 2 = Layout 2). The back jets are located at the end at which the technical equipment is installed.

For further options use the order form (see right-hand fold-out page)

Technical parts 1

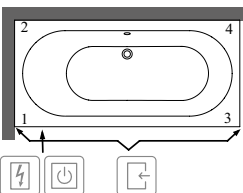

Technical parts 2

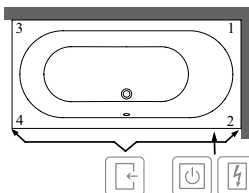

- Accessible via
- Control box
- Rim control

This symbol "○" means this option is possible

XX = Colour code to be indicated

For further information on colours, please see the page at the beginning of this section.

Further information on whirlpool systems please see page 585.

OBERON 2.0 Duo (Rectangle 1700 x 750) Quarryl®

€ excl. VAT

Included in scope of delivery:

Matching outlet and overflow is supplied as standard (chrome-plated and white).
 For baths in the colour RW, the outlet/overflow fittings are supplied in Chrome & White.
 If the water inlet is chosen in Black Matt (33) or Stone White (RW), the outlet cover is supplied in the same colour.
 Set of bath feet is supplied as standard (self-adhesive), adjustable from 130 à 180 mm.

Technical information:

The whirlpool system IP (Special Combipool Invisible) for baths in color Stone White (RW) will be delivered with Stone White (RW) colored jets. For all other pools in the color RW, the jets remain in Chrome.
Price for whirlpool system in the colour Stone White (RW) on request.

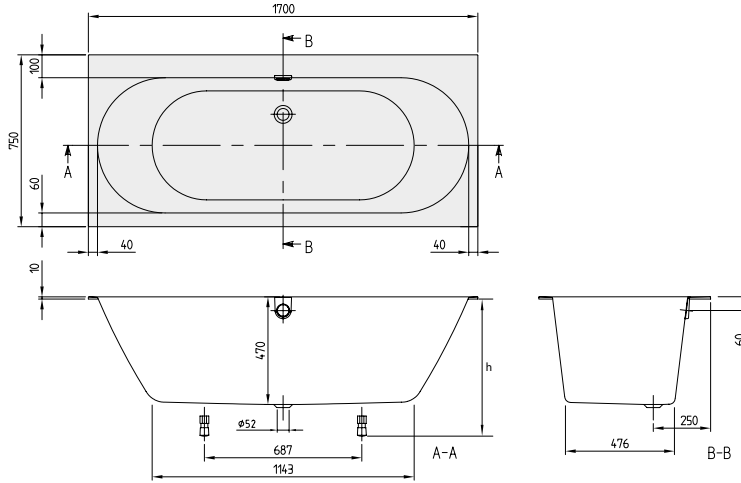

Quarryl®

h = Installation height (min - max)	
Bath	605 - 645
Whirlpool system	638 - 651
UNITED without system	610 - 610
UNITED incl. System	610 - 610
Profibox 2.0 without system	625 - 625
Profibox 2.0 incl. System	625 - 625

Article number	Description	Size l x w	Bottom l x w	Depth	Litres incl. 1 pers	Weight (kg)	01	RW	pcs/pal.
UBQ 170 OBR 2DV-XX	Oberon 2.0	1700 x 750	1143 x 476	470	168	41,6			8

Accessories for baths:

Article number	Description	Price
UCCON0475	Pipe interruptor, incl. connections	
U90170061	Handgrips, 1 pair = 2 grips, chrome	
U906100XX	Multifunction cushion, foam, 240 x 150 x 50 mm	
UPCON0136	Water inlet, plastic, integrated in the overflow, maximum water flow rate: 20 l/min, chrome-plated and White	
UPCON0136-RW	Water inlet, plastic, integrated in the overflow, maximum water flow rate: 20 l/min, Stone White (NEW)	
UPCON0136-33	Water inlet, plastic, integrated in the overflow, maximum water flow rate: 20 l/min, Black Matt (NEW)	
U909570RW	Overflow and outlet cover, Stone White (NEW)	
U90957033	Overflow and outlet cover, Black Matt (NEW)	

Preassembled bath options in combination with: For order form, see fold-out page on the right-hand side	only bath	Airpools		Hydropools		Combipools		Special Combipools	
		AE	AC	HE	HC	CE	CC	IP	AP
UNITED Free-standing	○	-	-	-	-	-	-	-	-
UNITED Corner	○	○	○	○	○	○	○	○	-
Profibox 2.0 alcove	○	○	○	○	○	○	○	○	-
Profibox 2.0 corner	○	○	○	○	○	○	○	○	-
TouchLight	○	-	-	-	-	-	-	-	-

Whirlpool Systems		Airpools		Hydropools		Combipools		Special Combipools	
Article number	Description	AE	AC	HE	HC	CE	CC	IP	AP
U__ 170 OBR 2A ½ V XX	Price of whirlpool system incl. bath								
U__ 170 OBR 2B ½ V XX	Price of whirlpool system incl. bath incl. water inlet								

For the following whirlpool systems the technology protrudes:

Technical parts 1	Side 1-3	-	-	-	-	-	-	-	+10
Technical parts 2	Side 1-3	-	-	-	-	-	-	-	+10

Please replace __ in article number with whirlpool code.

Please replace ½ in article number with desired position of technical equipment (1 = Layout 1, 2 = Layout 2). The back jets are located at the end at which the technical equipment is installed.

For further options use the order form (see right-hand fold-out page)

Technical parts 1

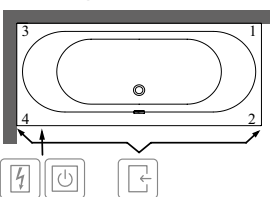

Technical parts 2

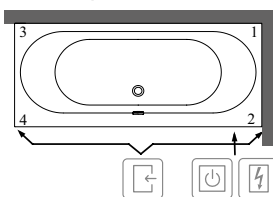

- Accessible via
- Control box
- Rim control

This symbol "○" means this option is possible

XX = Colour code to be indicated

For further information on colours, please see the page at the beginning of this section.

Further information on whirlpool systems please see page 585.

OBERON 2.0 Duo (Rectangle 1800 x 800) Quarryl®

€ excl. VAT

Included in scope of delivery:

Matching outlet and overflow is supplied as standard (chrome-plated and white).
 For baths in the colour RW, the outlet/overflow fittings are supplied in Chrome & White.
 If the water inlet is chosen in Black Matt (33) or Stone White (RW), the outlet cover is supplied in the same colour.
 Set of bath feet is supplied as standard (self-adhesive), adjustable from 130 à 180 mm.

Technical information:

The whirlpool system IP (Special Combipool Invisible) for baths in color Stone White (RW) will be delivered with Stone White (RW) colored jets. For all other pools in the color RW, the jets remain in Chrome.
Price for whirlpool system in the colour Stone White (RW) on request.

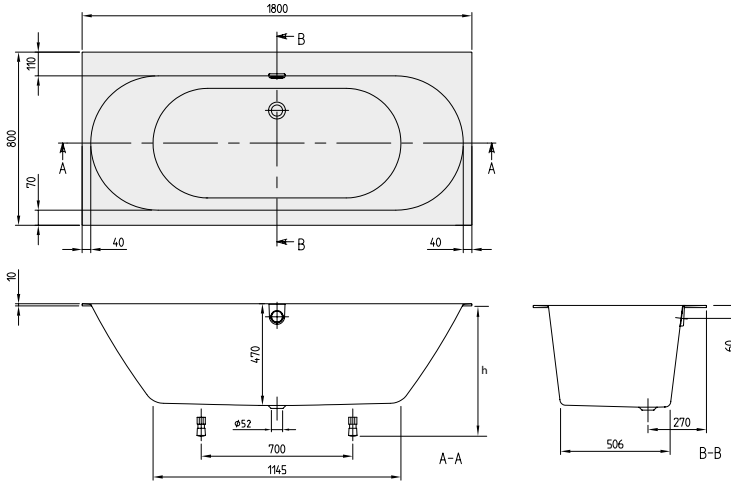

Quarryl®

h = Installation height (min - max)	
Bath	605 - 645
Whirlpool system	638 - 651
UNITED without system	610 - 610
UNITED incl. System	610 - 610
Profibox 2.0 without system	625 - 625
Profibox 2.0 incl. System	625 - 625

Article number	Description	Size l x w	Bottom l x w	Depth	Litres incl. 1 pers	Weight (kg)	01	RW	pcs/pal.
UBQ 180 OBR 2DV-XX	Oberon 2.0	1800 x 800	1145 x 506	470	190	45,2			8

Accessories for baths:

Article number	Description	Price
UCCON0475	Pipe interruptor, incl. connections	
U90170061	Handgrips, 1 pair = 2 grips, chrome	
U906100XX	Multifunction cushion, foam, 240 x 150 x 50 mm	
UPCON0136	Water inlet, plastic, integrated in the overflow, maximum water flow rate: 20 l/min, chrome-plated and White	
UPCON0136-RW	Water inlet, plastic, integrated in the overflow, maximum water flow rate: 20 l/min, Stone White (NEW)	
UPCON0136-33	Water inlet, plastic, integrated in the overflow, maximum water flow rate: 20 l/min, Black Matt (NEW)	
U909570RW	Overflow and outlet cover, Stone White (NEW)	
U90957033	Overflow and outlet cover, Black Matt (NEW)	

Preassembled bath options in combination with: For order form, see fold-out page on the right-hand side	only bath	Airpools		Hydropools		Combipools		Special Combipools	
		AE	AC	HE	HC	CE	CC	IP	AP
UNITED Free-standing	○	-	-	-	-	-	-	-	-
UNITED Corner	○	○	○	○	○	○	○	○	-
Profibox 2.0 alcove	○	○	○	○	○	○	○	○	-
Profibox 2.0 corner	○	○	○	○	○	○	○	○	-
TouchLight	○	-	-	-	-	-	-	-	-

Whirlpool Systems		Airpools		Hydropools		Combipools		Special Combipools	
Article number	Description	AE	AC	HE	HC	CE	CC	IP	AP
U __ 180 OBR 2A ½ V XX	Price of whirlpool system incl. bath								
U __ 180 OBR 2B ½ V XX	Price of whirlpool system incl. bath incl. water inlet								

For the following whirlpool systems the technology protrudes:

Technical parts 1	Side 1-3	-	-	-	-	-	-	-	+10
Technical parts 2	Side 1-3	-	-	-	-	-	-	-	+10

Please replace __ in article number with whirlpool code.

Please replace ½ in article number with desired position of technical equipment (1 = Layout 1, 2 = Layout 2). The back jets are located at the end at which the technical equipment is installed.

For further options use the order form (see right-hand fold-out page)

Technical parts 1

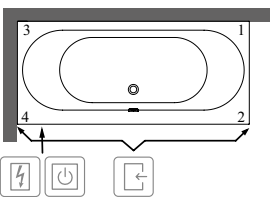

Technical parts 2

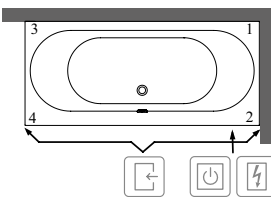

-  Accessible via
-  Control box
-  Rim control

This symbol "○" means this option is possible

XX = Colour code to be indicated

For further information on colours, please see the page at the beginning of this section.

Further information on whirlpool systems please see page 585.

OBERON 2.0 Solo (Rectangle 1800 x 800) Quarry®

NEW

€ excl. VAT

Included in scope of delivery:

Matching outlet and overflow is supplied as standard (chrome-plated and white).
 For baths in the colour RW, the outlet/overflow fittings are supplied in Chrome & White.
 If the water inlet is chosen in Black Matt (33) or Stone White (RW), the outlet cover is supplied in the same colour.
 Set of bath feet is supplied as standard (self-adhesive), adjustable from 130 à 180 mm.

Technical information:

The whirlpool system IP (Special Combipool Invisible) for baths in color Stone White (RW) will be delivered with Stone White (RW) colored jets. For all other pools in the color RW, the jets remain in Chrome.
Price for whirlpool system in the colour Stone White (RW) on request.

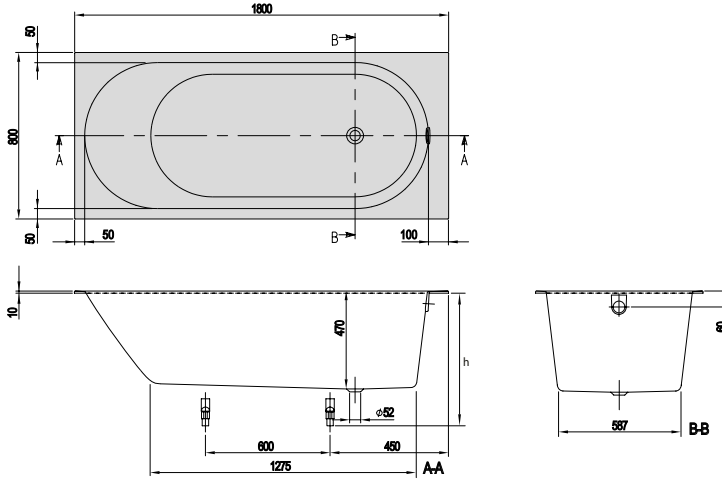

Quarry®

h = Installation height (min - max)	
Bath	605 - 655
Whirlpool system	630 - 670
UNITED without system	610 - 610
UNITED incl. System	610 - 610
Profibox 2.0 without system	585 - 585
Profibox 2.0 incl. System	625 - 625

Article number	Description	Size l x w	Bottom l x w	Depth	Litres incl. 1 pers	Weight (kg)	01	RW	pcs/pal.
UBQ 181 OBR 2DV-XX	Oberon 2.0	1800 x 800	1275 x 587	470	232	48,4			8

Accessories for baths:

Article number	Description	Price
UCCON0475	Pipe interruptor, incl. connections	
U90170061	Handgrips, 1 pair = 2 grips, chrome	
U906100XX	Multifunction cushion, foam, 240 x 150 x 50 mm	
UPCON0138	Water inlet, plastic, integrated in the overflow, maximum water flow rate: 20 l/min, chrome-plated and White (NEW)	
UPCON0138-RW	Water inlet, plastic, integrated in the overflow, maximum water flow rate: 20 l/min, Stone White (NEW)	
UPCON0138-33	Water inlet, plastic, integrated in the overflow, maximum water flow rate: 20 l/min, Black Matt (NEW)	
U909571RW	Overflow and outlet cover, Stone White (NEW)	
U90957133	Overflow and outlet cover, Black Matt (NEW)	

Preassembled bath options in combination with: For order form, see fold-out page on the right-hand side	only bath	Airpools		Hydropools		Combipools		Special Combipools	
		AE	AC	HE	HC	CE	CC	IP	AP
UNITED Free-standing	<input type="radio"/>	-	-	-	-	-	-	-	-
UNITED Corner	<input type="radio"/>	-	-	-	-	-	-	-	-
Profibox 2.0 alcove	<input type="radio"/>	<input type="radio"/>	<input type="radio"/>	<input type="radio"/>	-	<input type="radio"/>	-	-	-
Profibox 2.0 corner	<input type="radio"/>	<input type="radio"/>	<input type="radio"/>	<input type="radio"/>	-	<input type="radio"/>	-	-	-
TouchLight	<input type="radio"/>	-	-	-	-	-	-	-	-

Whirlpool Systems		Airpools		Hydropools		Combipools		Special Combipools	
Article number	Description	AE	AC	HE	HC	CE	CC	IP	AP
U __ 181 OBR 2A ½ V XX	Price of whirlpool system incl. bath								
U __ 181 OBR 2B ½ V XX	Price of whirlpool system incl. bath incl. water inlet								

For the following whirlpool systems the technology protrudes:

Technical parts 1	Side 1-3	Side 2-4	AE	AC	HE	HC	CE	CC	IP	AP
Technical parts 1	-	-	-	-	-	+10	-	+10	+10	+35
Technical parts 2	-	-	-	-	-	+10	-	+10	+10	+35
Technical parts 2	-	-	-	-	-	+10	-	+10	+10	+35
Technical parts 2	-	-	-	-	-	+10	-	+10	+10	+35

Please replace __ in article number with whirlpool code.

Please replace ½ in article number with desired position of technical equipment (1 = Layout 1, 2 = Layout 2). The back jets are located at the end at which the technical equipment is installed.

For further options use the order form (see right-hand fold-out page)

Technical parts 1

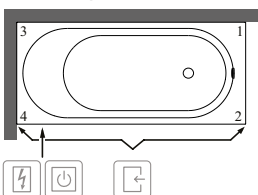

Technical parts 2

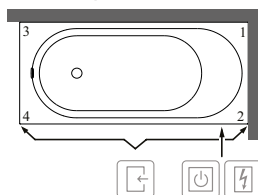

- Accessible via
- Control box
- Rim control

This symbol "O" means this option is possible

XX = Colour code to be indicated

For further information on colours, please see the page at the beginning of this section.

Further information on whirlpool systems please see page 585.

OBERON 2.0 Duo (Wall-facing 1800 x 800) Quaryl®

€ excl. VAT

Included in scope of delivery:

Matching outlet and overflow is supplied as standard (chrome-plated and white).
 For baths in the colour RW, the outlet/overflow fittings are supplied in Chrome & White.
 If the water inlet is chosen in Black Matt (33) or Stone White (RW), the outlet cover is supplied in the same colour.

Technical information:

Whirlpool systems available on request.
NEW: Whirlpool system Combipool Comfort (CC) also available.

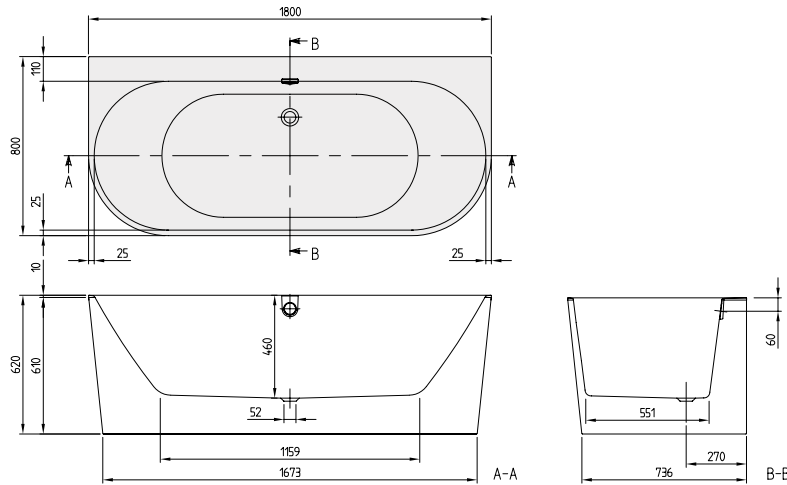

Quaryl®

BATHS

Article number	Description	Size l x w	Bottom l x w	Depth	Litres incl. 1 pers	Weight (kg)	01	RW	pcs/pal.
UBQ 180 OBR 9CD00V-XX	Oberon 2.0, wall-facing, incl. Quaryl® panel in the same colour as the bath	1800 x 800	1159 x 551	460	205	103,8			1

Accessories for baths:

Article number	Description	Price
UCCON0475	Pipe interruptor, incl. connections	
U906100XX	Multifunction cushion, foam, 240 x 150 x 50 mm	
UPCON0136	Water inlet, plastic, integrated in the overflow, maximum water flow rate: 20 l/min, chrome-plated and White	
UPCON0136-RW	Water inlet, plastic, integrated in the overflow, maximum water flow rate: 20 l/min, Stone White (NEW)	
UPCON0136-33	Water inlet, plastic, integrated in the overflow, maximum water flow rate: 20 l/min, Black Matt (NEW)	
U909570RW	Overflow and outlet cover, Stone White (NEW)	
U90957033	Overflow and outlet cover, Black Matt (NEW)	

XX = Colour code to be indicated
 For further information on colours, please see the page at the beginning of this section.
 Further information on whirlpool systems please see page 585.

OBERON 2.0 Duo (Wall-facing 1800 x 800) Quarry[®], Colour on Demand

€ excl. VAT

Included in scope of delivery:

Matching outlet and overflow is supplied as standard (chrome-plated and white).
 For baths in the colour RW, the outlet/overflow fittings are supplied in Chrome & White.
 If the water inlet is chosen in Black Matt (33) or Stone White (RW), the outlet cover is supplied in the same colour.

Technical information:

Whirlpool systems available on request.
NEW: Whirlpool system Combipool Comfort (CC) also available.

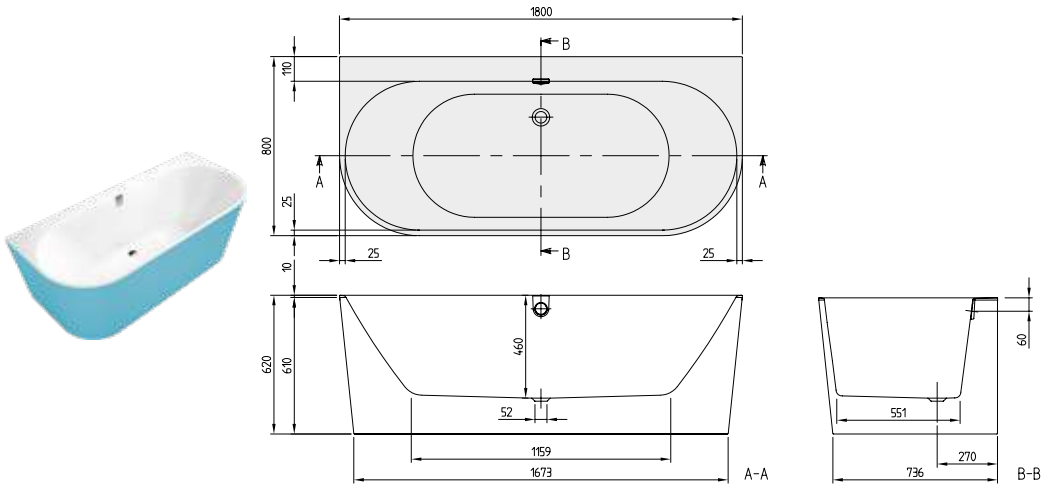

Article number	Description	Size l x w	Bottom l x w	Depth	Litres incl. 1 pers	Weight (kg)	01	RW	pcs/pal.
UBQ 180 OBR 9CDBCX-XX	Oberon 2.0, wall-facing, incl. panel in Colour on Demand (Quarry [®])	1800 x 800	1159 x 551	460	205	103,8			1

Accessories for baths:

Article number	Description	Price
UCCON0475	Pipe interruptor, incl. connections	
U906100XX	Multifunction cushion, foam, 240 x 150 x 50 mm	
UPCON0136	Water inlet, plastic, integrated in the overflow, maximum water flow rate: 20 l/min, chrome-plated and White	
UPCON0136-RW	Water inlet, plastic, integrated in the overflow, maximum water flow rate: 20 l/min, Stone White (NEW)	
UPCON0136-33	Water inlet, plastic, integrated in the overflow, maximum water flow rate: 20 l/min, Black Matt (NEW)	
U909570RW	Overflow and outlet cover, Stone White (NEW)	
U90957033	Overflow and outlet cover, Black Matt (NEW)	

Made-to-order production - Colour on Demand: 3 week delivery period. Please make sure to use the **order form** that you will find immediately after the chapter on baths on page 578-579, so that we can complete the order for you.

XX = Colour code to be indicated
 For further information on colours, please see the page at the beginning of this section.
 Further information on whirlpool systems please see page 585.

PAVIA Duo (Rectangle 1700 x 750) Quarryl®

€ excl. VAT

Included in scope of delivery: Set of bath feet is supplied as standard (self-adhesive), adjustable from 130 à 180 mm.
Not included in scope of delivery: Requires extended waste/overflow combination.
Technical information: Whirlpool systems available on request.
 United available for whirlpool systems on request

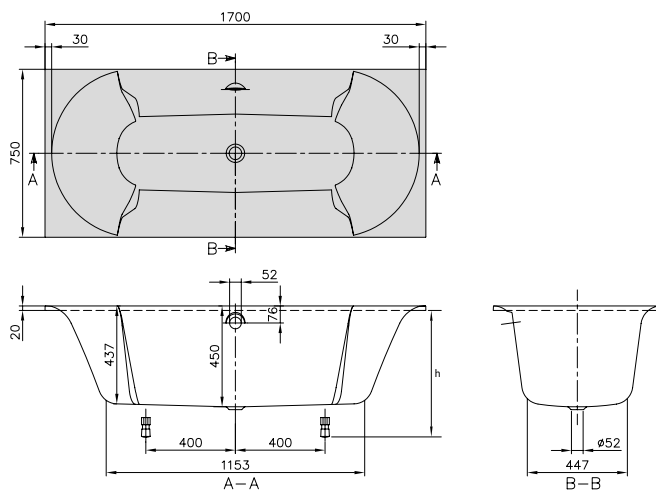

BATHS

Article number	Description	Size l x w	Bottom l x w	Depth	Litres incl. 1 pers	Weight (kg)	01	pcs/pal.
UBQ 170 PAV 2V-XX	Pavia	1700 x 750	1150 x 450	450	130	37,9		8

h = Installation height (min - max)	
Bath	585 - 635

Accessories for baths:

Article number	Description	Price
U90950461	Multiplex waste/overflow combination, chrome	
UCCON0475	Pipe interruptor, incl. connections	
U90600361	Multiplex Trio Outlet/overflow fitting with water inlet, chrome	
U90600461	Multiplex Trio Outlet/overflow fitting with water inlet and pipe interrupter, chrome	
U906100XX	Multifunction cushion, foam, 240 x 150 x 50 mm	

Preassembled bath options in combination with:

For order form, see fold-out page on the right-hand side

	Price
UNITED Free-standing	
UNITED Corner	
TouchLight	

XX = Colour code to be indicated
 For further information on colours, please see the page at the beginning of this section.
 Further information on whirlpool systems please see page 585.

SQUARO Duo (Rectangle 1700 x 750) Quarryl®

€ excl. VAT

Included in scope of delivery:

Set of bath feet is supplied as standard (self-adhesive), adjustable from 130 à 180 mm.

Not included in scope of delivery:

Requires extended waste/overflow combination.

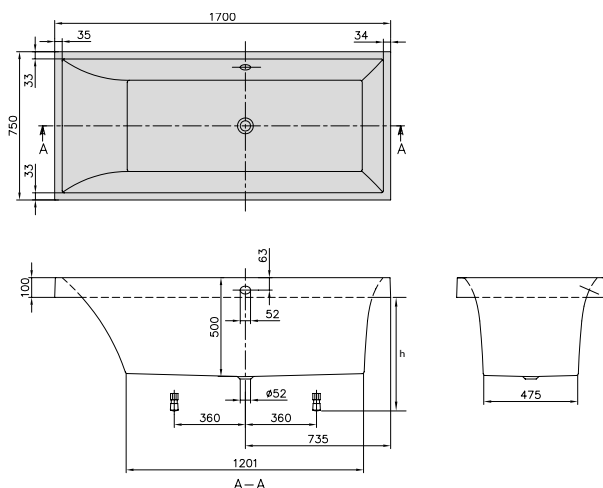

h = Installation height (min - max)	
Bath	555 - 605
Whirlpool system	580 - 620

Article number	Description	Size l x w	Bottom l x w	Depth	Litres incl. 1 pers	Weight (kg)	01	pcs/pal.
UBQ 170 SQR 2V-XX	Squaro	1700 x 750	1200 x 480	500	195	53,2		5

Accessories for baths:

Article number	Description	Price
U90950461	Multiplex waste/overflow combination, chrome	
UCCON0475	Pipe interruptor, incl. connections	
U90600361	Multiplex Trio Outlet/overflow fitting with water inlet, chrome	
U90600461	Multiplex Trio Outlet/overflow fitting with water inlet and pipe interruptor, chrome	
U90170061	Handgrips, 1 pair = 2 grips, chrome	
U906100XX	Multifunction cushion, foam, 240 x 150 x 50 mm	

Preassembled bath options in combination with: For order form, see fold-out page on the right-hand side	only bath	Airpools		Hydropools		Combipools		Special Combipools	
		AE	AC	HE	HC	CE	CC	IP	AP
TouchLight	○	-	-	-	-	-	-	-	-

Whirlpool Systems		Airpools		Hydropools		Combipools		Special Combipools	
Article number	Description	AE	AC	HE	HC	CE	CC	IP	AP
U__ 170 SQR 2A ½ V XX	Price of whirlpool system incl. bath								
U__ 170 SQR 2B ½ V XX	Price of whirlpool system incl. bath incl. Multiplex Trio								

Please replace __ in article number with whirlpool code.

Please replace ½ in article number with desired position of technical equipment (1 = Layout 1, 2 = Layout 2). The back jets are located at the end at which the technical equipment is installed.

For further options use the order form (see right-hand fold-out page)

Technical parts 1

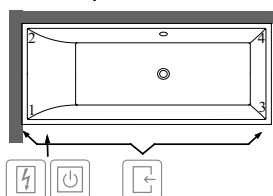

Technical parts 2

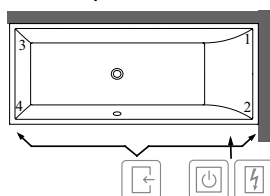

- Accessible via
- Control box
- Rim control

This symbol "○" means this option is possible

XX = Colour code to be indicated

For further information on colours, please see the page at the beginning of this section.

Further information on whirlpool systems please see page 585.

SQUARO Duo (Rectangle 1800 x 800) Quarryl®

€ excl. VAT

Included in scope of delivery:

Set of bath feet is supplied as standard (self-adhesive), adjustable from 130 à 180 mm.

Not included in scope of delivery:

Requires extended waste/overflow combination.

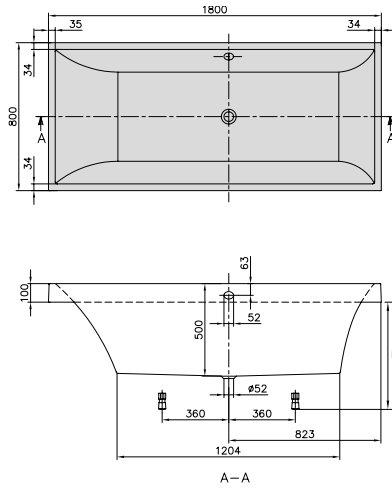

h = Installation height (min - max)	
Bath	555 - 605
Whirlpool system	580 - 620

Article number	Description	Size l x w	Bottom l x w	Depth	Litres incl. 1 pers	Weight (kg)	01	pcs/pal.
UBQ 180 SQR 2V-XX	Squaro	1800 x 800	1200 x 500	500	215	55,2		5

Accessories for baths:

Article number	Description	Price
U90950461	Multiplex waste/overflow combination, chrome	
UCCON0475	Pipe interruptor, incl. connections	
U90600361	Multiplex Trio Outlet/overflow fitting with water inlet, chrome	
U90600461	Multiplex Trio Outlet/overflow fitting with water inlet and pipe interruptor, chrome	
U90170061	Handgrips, 1 pair = 2 grips, chrome	
U906100XX	Multifunction cushion, foam, 240 x 150 x 50 mm	

Preassembled bath options in combination with: For order form, see fold-out page on the right-hand side	only bath	Airpools		Hydropools		Combipools		Special Combipools	
		AE	AC	HE	HC	CE	CC	IP	AP
TouchLight	○	-	-	-	-	-	-	-	-

Whirlpool Systems		Airpools		Hydropools		Combipools		Special Combipools	
Article number	Description	AE	AC	HE	HC	CE	CC	IP	AP
U__ 180 SQR 2A ½ V XX	Price of whirlpool system incl. bath								
U__ 180 SQR 2B ½ V XX	Price of whirlpool system incl. bath incl. Multiplex Trio								

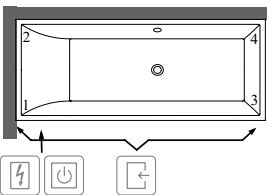

Please replace __ in article number with whirlpool code.
Please replace ½ in article number with desired position of technical equipment (1 = Layout 1, 2 = Layout 2). The back jets are located at the end at which the technical equipment is installed.
For further options use the order form (see right-hand fold-out page)

Technical parts 1

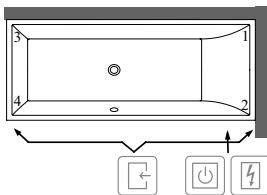

Technical parts 2



-  Accessible via
-  Control box
-  Rim control

This symbol "○" means this option is possible

XX = Colour code to be indicated

For further information on colours, please see the page at the beginning of this section.

Further information on whirlpool systems please see page 585.

BATHS

SQUARO (Corner 1450 x 1450) Quarry[®]

€ excl. VAT

Included in scope of delivery:

Set of bath feet is supplied as standard (self-adhesive), adjustable from 130 à 180 mm.

Not included in scope of delivery:

Requires extended waste/overflow combination.

Panel (optionally available, is always pre-installed at the factory). Please note: The panel cannot be retro-fitted.

Technical information:

The height of the panel is 550 mm

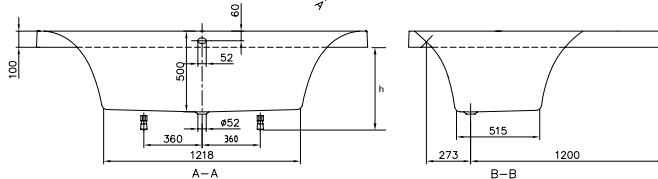
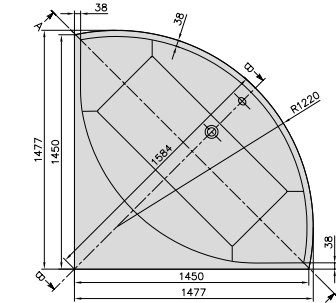

h = Installation height (min - max)	
Bath	555 - 605
Bath with panel	550 - 650
Whirlpool system	580 - 620

Article number	Description	Size l x w	Bottom l x w	Depth	Litres incl. 1 pers	Weight (kg)	01	pcs/pal.
UBQ 145 SQR 3V-XX	Squaro	1450 x 1450	1200 x 500	500	240	64,6		5

Accessories for baths:

Article number	Description	Price
U90950461	Multiplex waste/overflow combination, chrome	
UCCON0475	Pipe interruptor, incl. connections	
U90600361	Multiplex Trio Outlet/overflow fitting with water inlet, chrome	
U90600461	Multiplex Trio Outlet/overflow fitting with water inlet and pipe interrupter, chrome	
U906100XX	Multifunction cushion, foam, 240 x 150 x 50 mm	

Preassembled bath options in combination with: For order form, see fold-out page on the right-hand side	only bath	Airpools		Hydropools		Combipools		Special Combipools	
		AE	AC	HE	HC	CE	CC	IP	AP
Panel in the same colour as the bath	<input type="radio"/>	<input type="radio"/>	<input type="radio"/>	-	-	-	-	<input type="radio"/>	-
TouchLight	<input type="radio"/>	-	-	-	-	-	-	-	-

Whirlpool Systems	Article number	Description	Airpools		Hydropools		Combipools		Special Combipools	
			AE	AC	HE	HC	CE	CC	IP	AP
	U__ 145 SQR 3A ½ V XX	Price of whirlpool system incl. bath								
	U__ 145 SQR 3B ½ V XX	Price of whirlpool system incl. bath incl. Multiplex Trio								

For the following whirlpool systems the technology protrudes:

Technical parts	Side	AE	AC	HE	HC	CE	CC	IP	AP
Technical parts 1	Side 1-3	-	-	-	-	-	-	-	+35
	Side 1-4	-	-	-	-	-	-	-	+35
Technical parts 2	Side 1-4	-	-	-	-	-	-	-	+35
	Side 3-4	-	-	-	-	-	-	-	+35

Please replace __ in article number with whirlpool code.

Please replace ½ in article number with desired position of technical equipment (1 = Layout 1, 2 = Layout 2). The back jets are located at the end at which the technical equipment is installed.

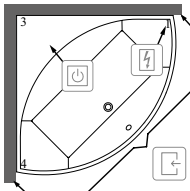

For further options use the order form (see right-hand fold-out page)

Technical parts 1

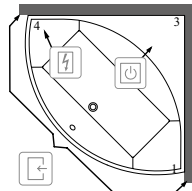

Technical parts 2



-  Accessible via
-  Control box
-  Rim control

This symbol "O" means this option is possible

XX = Colour code to be indicated

For further information on colours, please see the page at the beginning of this section.

Further information on whirlpool systems please see page 585.

SQUARO Duo (Hexagonal 1900 x 800) Quarryl®

€ excl. VAT

Included in scope of delivery: Set of bath feet is supplied as standard (self-adhesive), adjustable from 130 à 180 mm.
Not included in scope of delivery: Requires extended waste/overflow combination.
Technical information: In case of corner installation the diagonal dimension is 1344 mm.

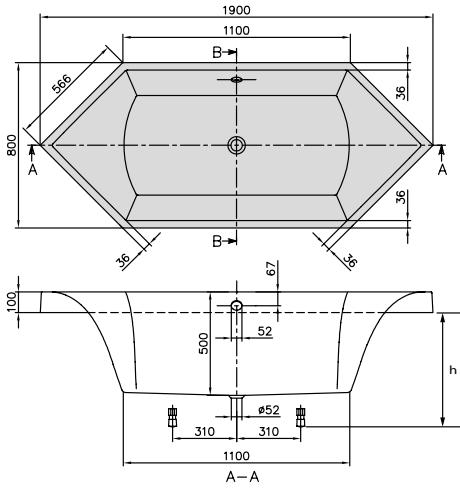

h = Installation height (min - max)	
Bath	555 - 605
Whirlpool system	580 - 620

Article number	Description	Size l x w	Bottom l x w	Depth	Litres incl. 1 pers	Weight (kg)	01	pcs/pal.
UBQ 190 SQR 6V-XX	Squaro	1900 x 800	1100 x 500	500	185	50,3		5

Accessories for baths:

Article number	Description	Price
U90950461	Multiplex waste/overflow combination, chrome	
UCCON0475	Pipe interruptor, incl. connections	
U90600361	Multiplex Trio Outlet/overflow fitting with water inlet, chrome	
U90600461	Multiplex Trio Outlet/overflow fitting with water inlet and pipe interruptor, chrome	
U90170061	Handgrips, 1 pair = 2 grips, chrome	
U906100XX	Multifunction cushion, foam, 240 x 150 x 50 mm	

Preassembled bath options in combination with: For order form, see fold-out page on the right-hand side	only bath	Airpools		Hydropools		Combipools		Special Combipools	
		AE	AC	HE	HC	CE	CC	IP	AP
TouchLight	○	-	-	-	-	-	-	-	-

Whirlpool Systems		Airpools		Hydropools		Combipools		Special Combipools	
Article number	Description	AE	AC	HE	HC	CE	CC	IP	AP
U__ 190 SQR 6A ½ V XX	Price of whirlpool system incl. bath								
U__ 190 SQR 6B ½ V XX	Price of whirlpool system incl. bath incl. Multiplex Trio								

For the following whirlpool systems the technology protrudes:

Technical parts 1	Side 3-6	Side 4-6	Side 1-5	Side 2-5
	-	-	-	-
	-	-	-	-
	-	-	-	-
	-	-	-	-

Please replace __ in article number with whirlpool code.
 Please replace ½ in article number with desired position of technical equipment (1 = Layout 1, 2 = Layout 2). The back jets are located at the end at which the technical equipment is installed.
For further options use the order form (see right-hand fold-out page)

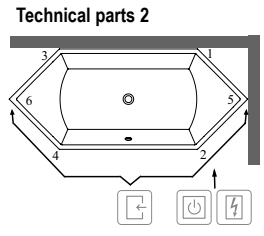
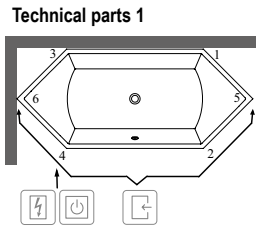

- Accessible via
- Control box
- Rim control

This symbol "○" means this option is possible
 XX = Colour code to be indicated
 For further information on colours, please see the page at the beginning of this section.
 Further information on whirlpool systems please see page 585.

BATHS

SQUARO EDGE 12 Duo (Rectangle 1600 x 750) Quarryl®

€ excl. VAT

Included in scope of delivery:

Matching outlet and overflow is supplied as standard (chrome-plated and white).
For baths in the colour RW, the outlet/overflow fittings are supplied in Chrome & White.
Set of bath feet is supplied as standard (self-adhesive), adjustable from 130 à 180 mm.

Technical information:

The whirlpool system IP (Special Combipool Invisible) for baths in color Stone White (RW) will be delivered with Stone White (RW) colored jets. For all other pools in the color RW, the jets remain in Chrome.
Price for whirlpool system in the colour Stone White (RW) on request.

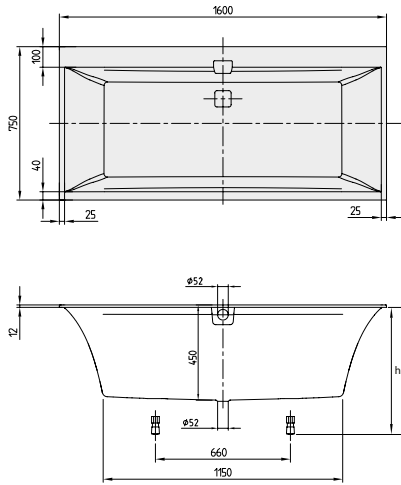

h = Installation height (min - max)	
Bath	595 - 645
Whirlpool system	620 - 660
Profibox 2.0 without system	585 - 585
Profibox 2.0 incl. System	625 - 625

Article number	Description	Size l x w	Bottom l x w	Depth	Litres incl. 1 pers	Weight (kg)	01	RW	pcs/pat.
UBQ 160 SQE 2DV-XX	Squaro Edge 12	1600 x 750	1150 x 460	450	160	41,1			5

Accessories for baths:

Article number	Description	Price
UCCON0475	Pipe interruptor, incl. connections	
U90170061	Handgrips, 1 pair = 2 grips, chrome	
U906100XX	Multifunction cushion, foam, 240 x 150 x 50 mm	
UPCON0123	Water inlet, plastic, integrated in the overflow, maximum water flow rate: 20 l/min, chrome-plated and White	
UPCON0123-RW	Water inlet, plastic, integrated in the overflow, maximum water flow rate: 20 l/min, Stone White (NEW)	
UPCON0123-33	Water inlet, plastic, integrated in the overflow, maximum water flow rate: 20 l/min, Black Matt (NEW)	
U909540RW	Overflow and outlet cover, Stone White (NEW)	
U90954033	Overflow and outlet cover, Black Matt (NEW)	

Preassembled bath options in combination with: For order form, see fold-out page on the right-hand side	only bath	Airpools		Hydropools		Combipools		Special Combipools	
		AE	AC	HE	HC	CE	CC	IP	AP
Profibox 2.0 alcove	○	○	○	○	-	○	-	-	-
Profibox 2.0 corner	○	○	○	○	-	○	-	-	-
TouchLight	○	-	-	-	-	-	-	-	-

Whirlpool Systems	Article number	Description	Airpools		Hydropools		Combipools		Special Combipools	
			AE	AC	HE	HC	CE	CC	IP	AP
	U _ 160 SQE 2A ½ V XX	Price of whirlpool system incl. bath								
	U _ 160 SQE 2B ½ V XX	Price of whirlpool system incl. bath incl. water inlet								

For the following whirlpool systems the technology protrudes:

Technical parts 1	Side 1-3	Side 3-4	Side 1-2	Side 1-3
	-	-	-	-
	-	-	-	-
Technical parts 2	-	-	-	-
	-	-	-	-
	-	-	-	-

Please replace __ in article number with whirlpool code.

Please replace ½ in article number with desired position of technical equipment (1 = Layout 1, 2 = Layout 2). The back jets are located at the end at which the technical equipment is installed.

For further options use the order form (see right-hand fold-out page)

Technical parts 1

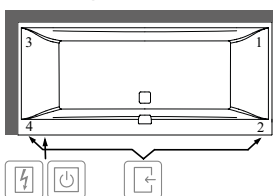

Technical parts 2

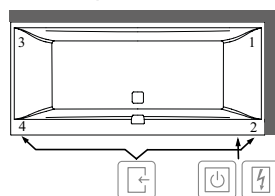

- Accessible via
- Control box
- Rim control

This symbol "O" means this option is possible

XX = Colour code to be indicated

For further information on colours, please see the page at the beginning of this section.

Further information on whirlpool systems please see page 585.

SQUARO EDGE 12 Duo (Rectangle 1700 x 750) Quarry®

€ excl. VAT

Included in scope of delivery:

Matching outlet and overflow is supplied as standard (chrome-plated and white).
For baths in the colour RW, the outlet/overflow fittings are supplied in Chrome & White.
Set of bath feet is supplied as standard (self-adhesive), adjustable from 130 à 180 mm.

Technical information:

The whirlpool system IP (Special Combipool Invisible) for baths in color Stone White (RW) will be delivered with Stone White (RW) colored jets. For all other pools in the color RW, the jets remain in Chrome.
Price for whirlpool system in the colour Stone White (RW) on request.

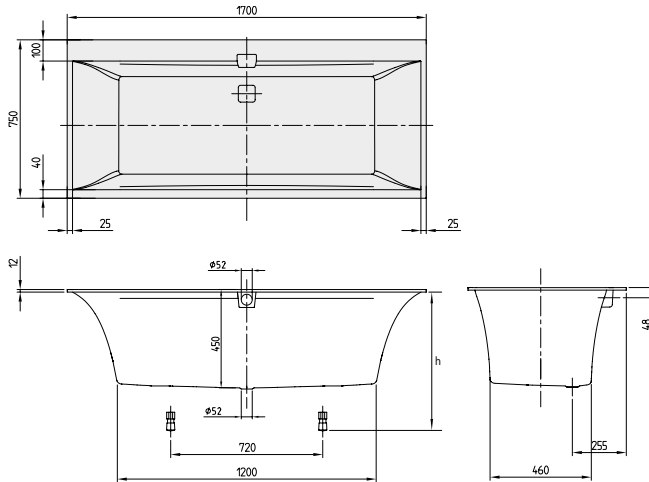

h = Installation height (min - max)	
Bath	595 - 645
Whirlpool system	620 - 660
UNITED without system	610 - 610
UNITED incl. System	610 - 610
Profibox 2.0 without system	585 - 585
Profibox 2.0 incl. System	625 - 625

Article number	Description	Size l x w	Bottom l x w	Depth	Litres incl. 1 pers	Weight (kg)	01	RW	pcs/pat.
UBQ 170 SQE 2DV-XX	Squaro Edge 12	1700 x 750	1200 x 460	450	165	43,6			5

Accessories for baths:

Article number	Description	Price
UCCON0475	Pipe interruptor, incl. connections	
U90170061	Handgrips, 1 pair = 2 grips, chrome	
U906100XX	Multifunction cushion, foam, 240 x 150 x 50 mm	
UPCON0123	Water inlet, plastic, integrated in the overflow, maximum water flow rate: 20 l/min, chrome-plated and White	
UPCON0123-RW	Water inlet, plastic, integrated in the overflow, maximum water flow rate: 20 l/min, Stone White (NEW)	
UPCON0123-33	Water inlet, plastic, integrated in the overflow, maximum water flow rate: 20 l/min, Black Matt (NEW)	
U909540RW	Overflow and outlet cover, Stone White (NEW)	
U90954033	Overflow and outlet cover, Black Matt (NEW)	

Preassembled bath options in combination with: For order form, see fold-out page on the right-hand side	only bath	Airpools		Hydropools		Combipools		Special Combipools	
		AE	AC	HE	HC	CE	CC	IP	AP
UNITED Free-standing	○	-	-	-	-	-	-	-	-
UNITED Corner	○	○	○	○	○	○	○	-	-
Profibox 2.0 alcove	○	○	○	○	○	○	○	○	-
Profibox 2.0 corner	○	○	○	○	○	○	○	○	-
TouchLight	○	-	-	-	-	-	-	-	-

Whirlpool Systems		Airpools		Hydropools		Combipools		Special Combipools	
Article number	Description	AE	AC	HE	HC	CE	CC	IP	AP
U__ 170 SQE 2A ½ V XX	Price of whirlpool system incl. bath								
U__ 170 SQE 2B ½ V XX	Price of whirlpool system incl. bath incl. water inlet								

For the following whirlpool systems the technology protrudes:

Technical parts 1	Side 1-3	Side 3-4	Technical parts 2	Side 1-2	Side 1-3
	-	-		-	-
	-	-		-	-
	-	-		-	-
	-	-		-	-

Please replace __ in article number with whirlpool code.

Please replace ½ in article number with desired position of technical equipment (1 = Layout 1, 2 = Layout 2). The back jets are located at the end at which the technical equipment is installed.

For further options use the order form (see right-hand fold-out page)

Technical parts 1

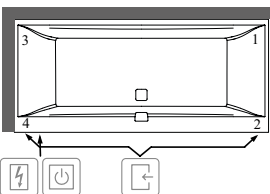

Technical parts 2

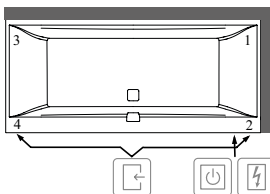

-  Accessible via
-  Control box
-  Rim control

This symbol "○" means this option is possible

XX = Colour code to be indicated

For further information on colours, please see the page at the beginning of this section.

Further information on whirlpool systems please see page 585.

SQUARO EDGE 12 Duo (Rectangle 1800 x 800) Quarryl®

€ excl. VAT

Included in scope of delivery:

Matching outlet and overflow is supplied as standard (chrome-plated and white).
For baths in the colour RW, the outlet/overflow fittings are supplied in Chrome & White.
Set of bath feet is supplied as standard (self-adhesive), adjustable from 130 à 180 mm.

Technical information:

The whirlpool system IP (Special Combipool Invisible) for baths in color Stone White (RW) will be delivered with Stone White (RW) colored jets. For all other pools in the color RW, the jets remain in Chrome.
Price for whirlpool system in the colour Stone White (RW) on request.

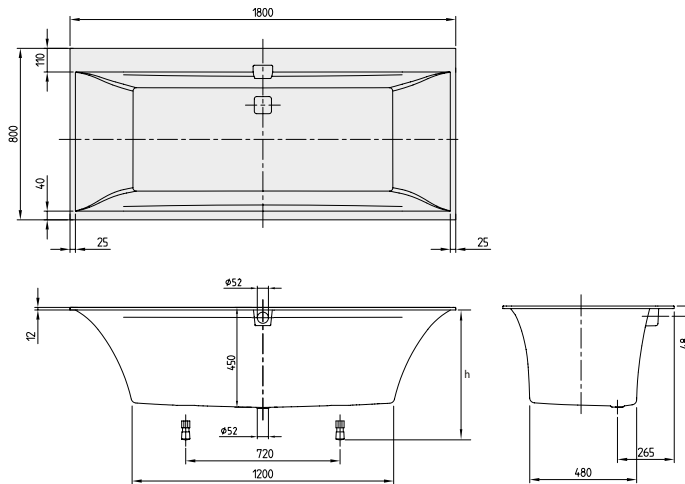

h = Installation height (min - max)	
Bath	595 - 645
Whirlpool system	620 - 660
UNITED without system	610 - 610
UNITED incl. System	610 - 610
Profibox 2.0 without system	585 - 585
Profibox 2.0 incl. System	625 - 625

Article number	Description	Size l x w	Bottom l x w	Depth	Litres incl. 1 pers	Weight (kg)	01	RW	pcs/pat.
UBQ 180 SQE 2DV-XX	Squaro Edge 12	1800 x 800	1200 x 480	450	180	43,4			5

Accessories for baths:

Article number	Description	Price
UCCON0475	Pipe interruptor, incl. connections	
U90170061	Handgrips, 1 pair = 2 grips, chrome	
U906100XX	Multifunction cushion, foam, 240 x 150 x 50 mm	
UPCON0123	Water inlet, plastic, integrated in the overflow, maximum water flow rate: 20 l/min, chrome-plated and White	
UPCON0123-RW	Water inlet, plastic, integrated in the overflow, maximum water flow rate: 20 l/min, Stone White (NEW)	
UPCON0123-33	Water inlet, plastic, integrated in the overflow, maximum water flow rate: 20 l/min, Black Matt (NEW)	
U909540RW	Overflow and outlet cover, Stone White (NEW)	
U90954033	Overflow and outlet cover, Black Matt (NEW)	

Preassembled bath options in combination with: For order form, see fold-out page on the right-hand side	only bath	Airpools		Hydropools		Combipools		Special Combipools	
		AE	AC	HE	HC	CE	CC	IP	AP
UNITED Free-standing	○	-	-	-	-	-	-	-	-
UNITED Corner	○	○	○	○	○	○	○	○	-
Profibox 2.0 alcove	○	○	○	○	○	○	○	○	-
Profibox 2.0 corner	○	○	○	○	○	○	○	○	-
TouchLight	○	-	-	-	-	-	-	-	-

Whirlpool Systems		Airpools		Hydropools		Combipools		Special Combipools	
Article number	Description	AE	AC	HE	HC	CE	CC	IP	AP
U__ 180 SQE 2A ½ V XX	Price of whirlpool system incl. bath								
U__ 180 SQE 2B ½ V XX	Price of whirlpool system incl. bath incl. water inlet								

For the following whirlpool systems the technology protrudes:

Technical parts 1	Side 3-4								
Technical parts 2	Side 1-2	-	-	-	-	-	-	-	+10
		-	-	-	-	-	-	-	+10

Please replace __ in article number with whirlpool code.

Please replace ½ in article number with desired position of technical equipment (1 = Layout 1, 2 = Layout 2). The back jets are located at the end at which the technical equipment is installed.

For further options use the order form (see right-hand fold-out page)

Technical parts 1

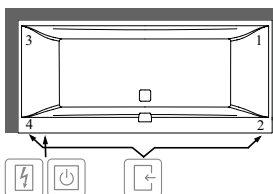

Technical parts 2

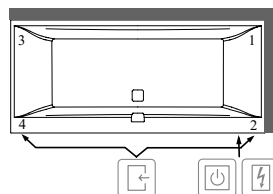

- Accessible via
- Control box
- Rim control

This symbol "O" means this option is possible

XX = Colour code to be indicated

For further information on colours, please see the page at the beginning of this section.

Further information on whirlpool systems please see page 585.

SQUARO EDGE 12 Duo (Rectangle 1900 x 900) Quarry®

€ excl. VAT

Included in scope of delivery:

Matching outlet and overflow is supplied as standard (chrome-plated and white).
For baths in the colour RW, the outlet/overflow fittings are supplied in Chrome & White.
Set of bath feet is supplied as standard (self-adhesive), adjustable from 130 à 180 mm.

Technical information:

The whirlpool system IP (Special Combipool Invisible) for baths in color Stone White (RW) will be delivered with Stone White (RW) colored jets. For all other pools in the color RW, the jets remain in Chrome.
Price for whirlpool system in the colour Stone White (RW) on request.

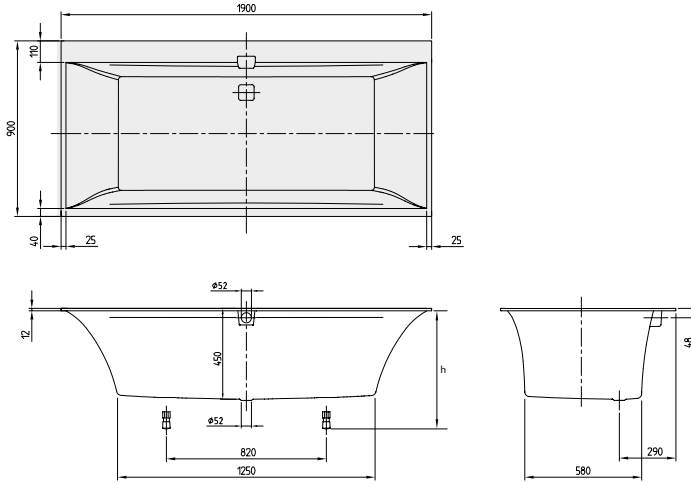

Quarry®

h = Installation height (min - max)	
Bath	595 - 645
Whirlpool system	620 - 660
UNITED without system	610 - 610
UNITED incl. System	610 - 610
Profibox 2.0 without system	585 - 585
Profibox 2.0 incl. System	625 - 625

Article number	Description	Size l x w	Bottom l x w	Depth	Litres incl. 1 pers	Weight (kg)	01	RW	pcs/pal.
UBQ 190 SQE 2DV-XX	Squaro Edge 12	1900 x 900	1250 x 580	450	240	54,5			5

Accessories for baths:

Article number	Description	Price
UCCON0475	Pipe interruptor, incl. connections	
U90170061	Handgrips, 1 pair = 2 grips, chrome	
U906100XX	Multifunction cushion, foam, 240 x 150 x 50 mm	
UPCON0123	Water inlet, plastic, integrated in the overflow, maximum water flow rate: 20 l/min, chrome-plated and White	
UPCON0123-RW	Water inlet, plastic, integrated in the overflow, maximum water flow rate: 20 l/min, Stone White (NEW)	
UPCON0123-33	Water inlet, plastic, integrated in the overflow, maximum water flow rate: 20 l/min, Black Matt (NEW)	
U909540RW	Overflow and outlet cover, Stone White (NEW)	
U90954033	Overflow and outlet cover, Black Matt (NEW)	

Preassembled bath options in combination with: For order form, see fold-out page on the right-hand side	only bath	Airpools		Hydropools		Combipools		Special Combipools	
		AE	AC	HE	HC	CE	CC	IP	AP
UNITED Free-standing	○	-	-	-	-	-	-	-	-
UNITED Corner	○	○	○	○	○	○	○	○	-
Profibox 2.0 alcove	○	○	○	○	○	○	○	○	-
Profibox 2.0 corner	○	○	○	○	○	○	○	○	-
TouchLight	○	-	-	-	-	-	-	-	-

Whirlpool Systems		Airpools		Hydropools		Combipools		Special Combipools	
Article number	Description	AE	AC	HE	HC	CE	CC	IP	AP
U__ 190 SQE 2A ½ V XX	Price of whirlpool system incl. bath								
U__ 190 SQE 2B ½ V XX	Price of whirlpool system incl. bath incl. water inlet								

For the following whirlpool systems the technology protrudes:

Technical parts 1	Side 1-3	-	-	-	-	-	-	-	+5
Technical parts 2	Side 1-3	-	-	-	-	-	-	-	+5

Please replace __ in article number with whirlpool code.

Please replace ½ in article number with desired position of technical equipment (1 = Layout 1, 2 = Layout 2). The back jets are located at the end at which the technical equipment is installed.

For further options use the order form (see right-hand fold-out page)

Technical parts 1

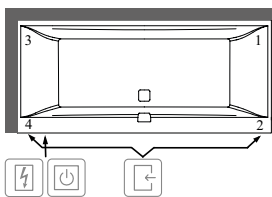

Technical parts 2

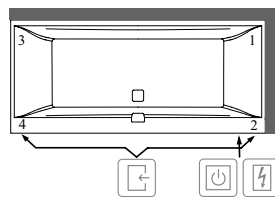

- Accessible via
- Control box
- Rim control

This symbol "O" means this option is possible

XX = Colour code to be indicated

For further information on colours, please see the page at the beginning of this section.

Further information on whirlpool systems please see page 585.

SQUARO EDGE 12 Duo (Oval 1800 x 800) Quarry[®]

€ excl. VAT

Included in scope of delivery:

Matching outlet and overflow is supplied as standard (chrome-plated and white).
For baths in the colour RW, the outlet/overflow fittings are supplied in Chrome & White.
Set of bath feet is supplied as standard (self-adhesive), adjustable from 130 à 180 mm.

Technical information:

The whirlpool system IP (Special Combipool Invisible) for baths in color Stone White (RW) will be delivered with Stone White (RW) colored jets. For all other pools in the color RW, the jets remain in Chrome.
Price for whirlpool system in the colour Stone White (RW) on request.

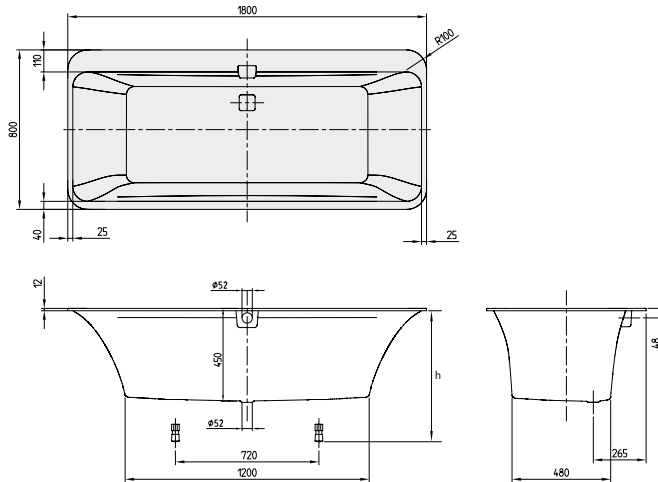

Quarry[®]

h = Installation height (min - max)	
Bath	595 - 645
Whirlpool system	620 - 660

Article number	Description	Size l x w	Bottom l x w	Depth	Litres incl. 1 pers	Weight (kg)	01	RW	pcs/pat.
UBQ 180 SQE 7DV-XX	Squaro Edge 12	1800 x 800	1200 x 480	450	180	43,8			5

Accessories for baths:

Article number	Description	Price
UCCON0475	Pipe interruptor, incl. connections	
U90170061	Handgrips, 1 pair = 2 grips, chrome	
U906100XX	Multifunction cushion, foam, 240 x 150 x 50 mm	
UPCON0123	Water inlet, plastic, integrated in the overflow, maximum water flow rate: 20 l/min, chrome-plated and White	
UPCON0123-RW	Water inlet, plastic, integrated in the overflow, maximum water flow rate: 20 l/min, Stone White (NEW)	
UPCON0123-33	Water inlet, plastic, integrated in the overflow, maximum water flow rate: 20 l/min, Black Matt (NEW)	
U909540RW	Overflow and outlet cover, Stone White (NEW)	
U90954033	Overflow and outlet cover, Black Matt (NEW)	

Preassembled bath options in combination with: For order form, see fold-out page on the right-hand side	only bath	Airpools		Hydropools		Combipools		Special Combipools	
		AE	AC	HE	HC	CE	CC	IP	AP
TouchLight	○	-	-	-	-	-	-	-	-

Whirlpool Systems		Airpools		Hydropools		Combipools		Special Combipools	
Article number	Description	AE	AC	HE	HC	CE	CC	IP	AP
U__ 180 SQE 7A ½ V XX	Price of whirlpool system incl. bath								
U__ 180 SQE 7B ½ V XX	Price of whirlpool system incl. bath incl. water inlet								

For the following whirlpool systems the technology protrudes:

Technical parts 1	Side 3-4	-	-	-	-	-	-	-	+10
Technical parts 2	Side 1-2	-	-	-	-	-	-	-	+10

Please replace __ in article number with whirlpool code.

Please replace ½ in article number with desired position of technical equipment (1 = Layout 1, 2 = Layout 2). The back jets are located at the end at which the technical equipment is installed.

For further options use the order form (see right-hand fold-out page)

Technical parts 1

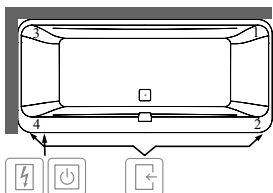

Technical parts 2

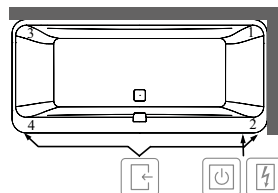

-  Accessible via
-  Control box
-  Rim control

This symbol "○" means this option is possible

XX = Colour code to be indicated

For further information on colours, please see the page at the beginning of this section.

Further information on whirlpool systems please see page 585.

SQUARO EDGE 12 Duo (Free-standing 1800 x 800) Quaryl®

€ excl. VAT

Included in scope of delivery:

Matching outlet and overflow is supplied as standard (chrome-plated and white).
For baths in the colour RW, the outlet/overflow fittings are supplied in Chrome & White.

Technical information:

Whirlpool systems available on request.

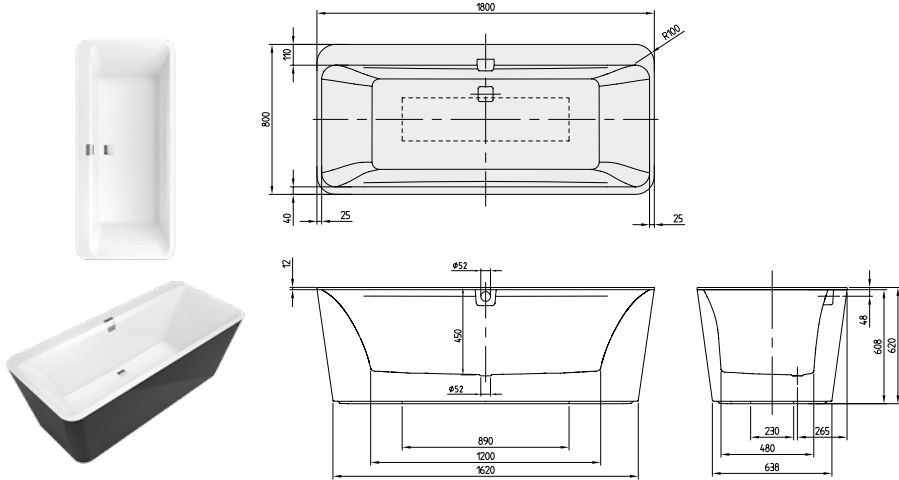

Quaryl®

BATHS

Article number	Description	Size l x w	Bottom l x w	Depth	Litres incl. 1 pers	Weight (kg)	01	RW	pcs/pal.
UBQ 180 SQE 7PDV-XX	Squaro Edge 12, incl. panel in the same colour as the bath	1800 x 800	1200 x 480	450	180	109,8			1
UBQ 180 SQE 7PDT1V-01	Squaro Edge 12, incl. Quaryl® panel (Graphite Noir)								1

Accessories for baths:

Article number	Description	Price
UCCON0475	Pipe interruptor, incl. connections	
U90170061	Handgrips, 1 pair = 2 grips, chrome	
U906100XX	Multifunction cushion, foam, 240 x 150 x 50 mm	
UPCON0123	Water inlet, plastic, integrated in the overflow, maximum water flow rate: 20 l/min, chrome-plated and White	
UPCON0123-RW	Water inlet, plastic, integrated in the overflow, maximum water flow rate: 20 l/min, Stone White (NEW)	
UPCON0123-33	Water inlet, plastic, integrated in the overflow, maximum water flow rate: 20 l/min, Black Matt (NEW)	
U909540RW	Overflow and outlet cover, Stone White (NEW)	
U90954033	Overflow and outlet cover, Black Matt (NEW)	

XX = Colour code to be indicated
For further information on colours, please see the page at the beginning of this section.
Further information on whirlpool systems please see page 585.

SQUARO EDGE 12 Duo (Free-standing 1800 x 800) Quarry[®], Colour on Demand

€ excl. VAT

Included in scope of delivery:

Matching outlet and overflow is supplied as standard (chrome-plated and white).
For baths in the colour RW, the outlet/overflow fittings are supplied in Chrome & White.

Technical information:

Whirlpool systems available on request.

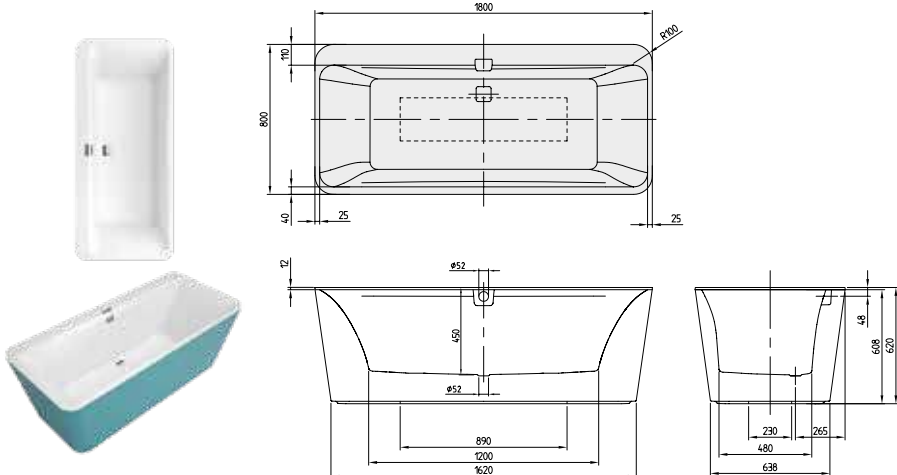

Article number	Description	Size l x w	Bottom l x w	Depth	Litres incl. 1 pers	Weight (kg)	01	RW	pcs/pal.
UBQ 180 SQE 7PDBCX-XX	Squaro Edge 12, freestanding, incl. panel in Colour on Demand (Quarry [®])	1800 x 800	1200 x 480	450	180	109,8			1

Accessories for baths:

Article number	Description	Price
UCCON0475	Pipe interruptor, incl. connections	
U90170061	Handgrips, 1 pair = 2 grips, chrome	
U906100XX	Multifunction cushion, foam, 240 x 150 x 50 mm	
UPCON0123	Water inlet, plastic, integrated in the overflow, maximum water flow rate: 20 l/min, chrome-plated and White	
UPCON0123-RW	Water inlet, plastic, integrated in the overflow, maximum water flow rate: 20 l/min, Stone White (NEW)	
UPCON0123-33	Water inlet, plastic, integrated in the overflow, maximum water flow rate: 20 l/min, Black Matt (NEW)	
U909540RW	Overflow and outlet cover, Stone White (NEW)	
U90954033	Overflow and outlet cover, Black Matt (NEW)	

Made-to-order production - Colour on Demand: 3 week delivery period. Please make sure to use the **order form** that you will find immediately after the chapter on baths on page 578-579, so that we can complete the order for you.

XX = Colour code to be indicated
For further information on colours, please see the page at the beginning of this section.
Further information on whirlpool systems please see page 585.

SQUARO EDGE 12 Excellence Duo (Free-standing 1800 x 800) Quarryl®

€ excl. VAT

Included in scope of delivery:

Matching outlet and overflow is supplied as standard (chrome-plated and white).
For baths in the colour RW, the outlet/overflow fittings are supplied in Chrome & White.

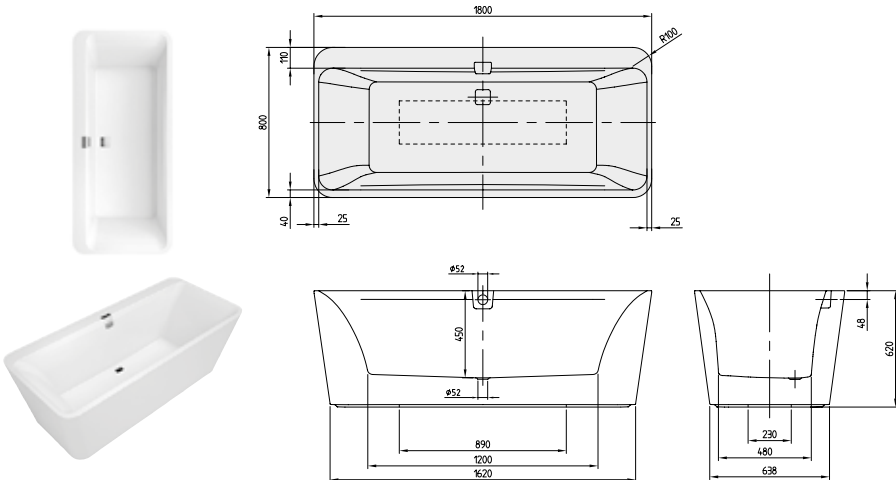

BATHS

Article number	Description	Size l x w	Bottom l x w	Depth	Litres incl. 1 pers	Weight (kg)	01	RW	pcs/pal.
UBQ 180 SQE 9W2V-XX	Squaro Edge 12, seamless, incl. pre-fitted outlet and overflow (chrome plated), Excellence	1800 x 800	1200 x 480	450	180	97,4			1
UBQ 180 SQE 9T2V-XX	Squaro Edge 12, seamless, including pre-fitted water inlet (chrome-plated), Excellence								1

Accessories for baths:

Article number	Description	Price
UCCON0475	Pipe interruptor, incl. connections	
U90170061	Handgrips, 1 pair = 2 grips, chrome	
U906100XX	Multifunction cushion, foam, 240 x 150 x 50 mm	
UPCON0123	Water inlet, plastic, integrated in the overflow, maximum water flow rate: 20 l/min, chrome-plated and White	
UPCON0123-RW	Water inlet, plastic, integrated in the overflow, maximum water flow rate: 20 l/min, Stone White (NEW)	
UPCON0123-33	Water inlet, plastic, integrated in the overflow, maximum water flow rate: 20 l/min, Black Matt (NEW)	
U909540RW	Overflow and outlet cover, Stone White (NEW)	
U90954033	Overflow and outlet cover, Black Matt (NEW)	

XX = Colour code to be indicated
For further information on colours, please see the page at the beginning of this section.
Further information on whirlpool systems please see page 585.

SQUARO EDGE 12 Excellence Duo (Free-standing 1800 x 800) Quarryl®, Colour on Demand

€ excl. VAT

Included in scope of delivery:

Matching outlet and overflow is supplied as standard (chrome-plated and white).
For baths in the colour RW, the outlet/overflow fittings are supplied in Chrome & White.

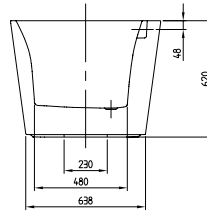
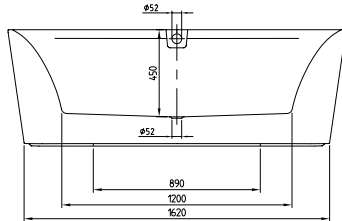
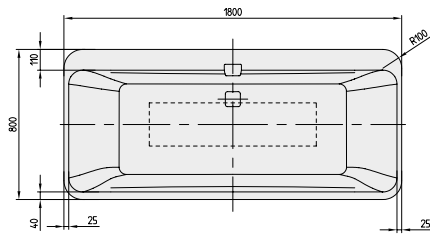

Article number	Description	Size l x w	Bottom l x w	Depth	Litres incl. 1 pers	Weight (kg)	01	RW	pcs/pat.
UBQ 180 SQE 9T2BCV-XX	Squaro Edge 12, seamless, Colour on Demand (Quaryl®), including pre-fitted water inlet (chrome-plated), Excellence	1800 x 800	1200 x 480	450	180	97,4			1
UBQ 180 SQE 9W2BCV-XX	Squaro Edge 12, seamless, Colour on Demand (Quaryl®), incl. pre-fitted outlet and overflow (chrome plated), Excellence								1

Accessories for baths:

Article number	Description	Price
UCCON0475	Pipe interruptor, incl. connections	
U90170061	Handgrips, 1 pair = 2 grips, chrome	
U906100XX	Multifunction cushion, foam, 240 x 150 x 50 mm	
UPCON0123	Water inlet, plastic, integrated in the overflow, maximum water flow rate: 20 l/min, chrome-plated and White	
UPCON0123-RW	Water inlet, plastic, integrated in the overflow, maximum water flow rate: 20 l/min, Stone White (NEW)	
UPCON0123-33	Water inlet, plastic, integrated in the overflow, maximum water flow rate: 20 l/min, Black Matt (NEW)	
U909540RW	Overflow and outlet cover, Stone White (NEW)	
U90954033	Overflow and outlet cover, Black Matt (NEW)	

Made-to-order production - Colour on Demand: 3 week delivery period. Please make sure to use the **order form** that you will find immediately after the chapter on baths on page 578-579, so that we can complete the order for you.

XX = Colour code to be indicated
For further information on colours, please see the page at the beginning of this section.
Further information on whirlpool systems please see page 585.

SUBWAY Duo (Rectangle 1600 x 700) Acrylic

€ excl. VAT

Not included in scope of delivery: Set of bath feet is not supplied as standard.
Matching sanitary ceramics: Subway

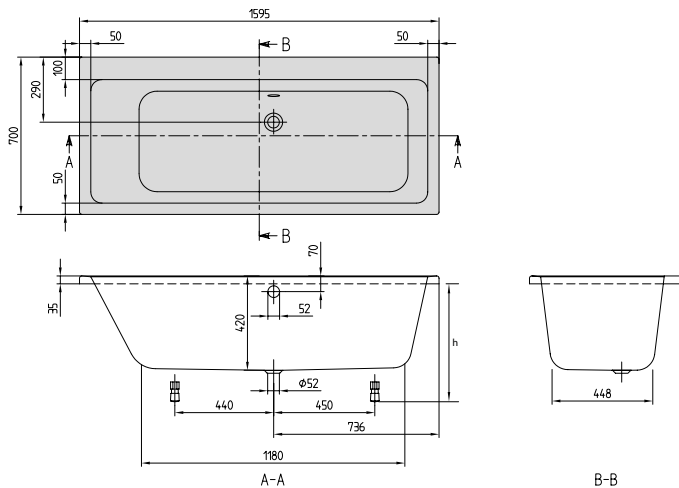

h = Installation height (min - max)	
Bath	525 - 575
Whirlpool system	565 - 605
Profibox 2.0 without system	585 - 585
Profibox 2.0 incl. System	625 - 625

Article number	Description	Size l x w	Bottom l x w	Depth	Litres incl. 1 pers	Weight (kg)	01	pcs/pat.
UBA 167 SUB 2V-XX	Subway	1600 x 700	1200 x 440	420	125	20		10

Accessories for baths:

Article number	Description	Price
U99740000	Bath feet, plastic, for baths with even bottom, adjustable from 130 à 180 mm	
U90950461	Multiplex waste/overflow combination, chrome	
UCCON0475	Pipe interruptor, incl. connections	
U90600361	Multiplex Trio Outlet/overflow fitting with water inlet, chrome	
U90600461	Multiplex Trio Outlet/overflow fitting with water inlet and pipe interruptor, chrome	
U90170061	Handgrips, 1 pair = 2 grips, chrome	
U906100XX	Multifunction cushion, foam, 240 x 150 x 50 mm	

Preassembled bath options in combination with: For order form, see fold-out page on the right-hand side	only bath	Airpools		Hydropools		Combipools		Special Combipools	
		AE	AC	HE	HC	CE	CC	IP	AP
Profibox 2.0 alcove	○	○	○	○	-	○	-	-	-
Profibox 2.0 corner	○	○	○	○	-	○	-	-	-
TouchLight	○	-	-	-	-	-	-	-	-

Whirlpool Systems	Article number	Description	Airpools		Hydropools		Combipools		Special Combipools	
			AE	AC	HE	HC	CE	CC	IP	AP
	U__ 167 SUB 2A ½ V XX	Price of whirlpool system incl. bath								
	U__ 167 SUB 2B ½ V XX	Price of whirlpool system incl. bath incl. Multiplex Trio								

For the following whirlpool systems the technology protrudes:

Technical parts	Side	AE	AC	HE	HC	CE	CC	IP	AP
Technical parts 1	Side 1-2	-	-	-	-	-	-	-	+40
	Side 1-3	-	-	-	+10	-	+10	+10	+30
Technical parts 2	Side 1-2	-	-	-	-	-	-	-	+40
	Side 1-3	-	-	-	+10	-	+10	+10	+30

Please replace __ in article number with whirlpool code.

Please replace ½ in article number with desired position of technical equipment (1 = Layout 1, 2 = Layout 2). The back jets are located at the end at which the technical equipment is installed.

For further options use the order form (see right-hand fold-out page)

Technical parts 1

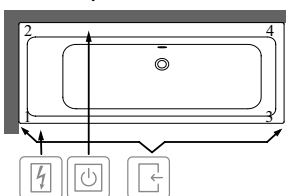

Technical parts 2

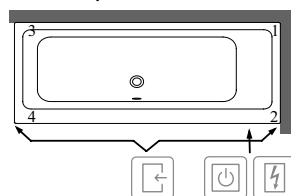

-  Accessible via
-  Control box
-  Rim control

This symbol "○" means this option is possible

XX = Colour code to be indicated

For further information on colours, please see the page at the beginning of this section.

Further information on whirlpool systems please see page 585.

BATHS

SUBWAY Duo (Rectangle 1700 x 750) Acrylic

€ excl. VAT

Not included in scope of delivery: Set of bath feet is not supplied as standard.
Matching sanitary ceramics: Subway

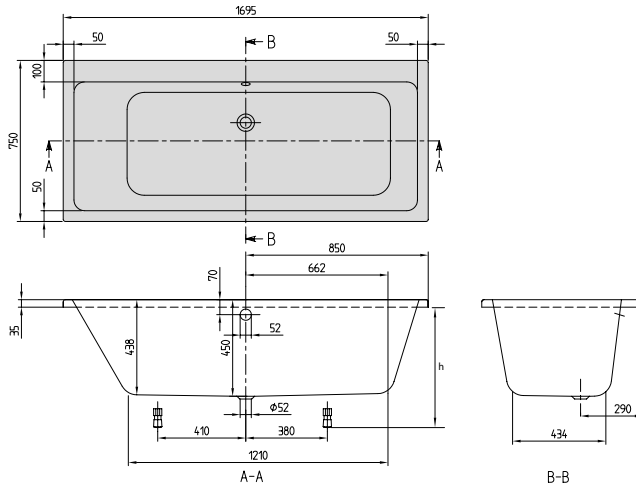

h = Installation height (min - max)	
Bath	555 - 605
Whirlpool system	595 - 635
Profibox 2.0 without system	585 - 585
Profibox 2.0 incl. System	625 - 625

Article number	Description	Size l x w	Bottom l x w	Depth	Litres incl. 1 pers	Weight (kg)	01	pcs/pal.
UBA 170 SUB 2V-XX	Subway	1700 x 750	1210 x 470	450	160	22		10

Accessories for baths:

Article number	Description	Price
U99740000	Bath feet, plastic, for baths with even bottom, adjustable from 130 à 180 mm	
U90950461	Multiplex waste/overflow combination, chrome	
UCCON0475	Pipe interruptor, incl. connections	
U90600361	Multiplex Trio Outlet/overflow fitting with water inlet, chrome	
U90600461	Multiplex Trio Outlet/overflow fitting with water inlet and pipe interruptor, chrome	
U90170061	Handgrips, 1 pair = 2 grips, chrome	
U906100XX	Multifunction cushion, foam, 240 x 150 x 50 mm	

Preassembled bath options in combination with: For order form, see fold-out page on the right-hand side	only bath	Airpools		Hydropools		Combipools		Special Combipools	
		AE	AC	HE	HC	CE	CC	IP	AP
Profibox 2.0 alcove	<input type="radio"/>	<input type="radio"/>	<input type="radio"/>	<input type="radio"/>	<input type="radio"/>	<input type="radio"/>	<input type="radio"/>	-	-
Profibox 2.0 corner	<input type="radio"/>	<input type="radio"/>	<input type="radio"/>	<input type="radio"/>	<input type="radio"/>	<input type="radio"/>	<input type="radio"/>	-	-
TouchLight	<input type="radio"/>	-	-	-	-	-	-	-	-

Whirlpool Systems	Article number	Description	Airpools		Hydropools		Combipools		Special Combipools	
			AE	AC	HE	HC	CE	CC	IP	AP
	U__ 170 SUB 2A ½ V XX	Price of whirlpool system incl. bath								
	U__ 170 SUB 2B ½ V XX	Price of whirlpool system incl. bath incl. Multiplex Trio								

For the following whirlpool systems the technology protrudes:

Technical parts	Side	AE	AC	HE	HC	CE	CC	IP	AP
Technical parts 1	Side 1-2	-	-	-	-	-	-	-	+30
	Side 1-3	-	-	-	-	-	-	+10	+30
Technical parts 2	Side 1-2	-	-	-	-	-	-	-	+30
	Side 1-3	-	-	-	-	-	-	+10	+30

Please replace __ in article number with whirlpool code.

Please replace ½ in article number with desired position of technical equipment (1 = Layout 1, 2 = Layout 2). The back jets are located at the end at which the technical equipment is installed.

For further options use the order form (see right-hand fold-out page)

Technical parts 1

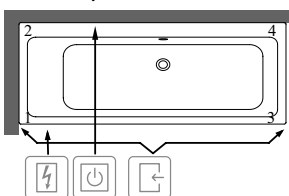

Technical parts 2

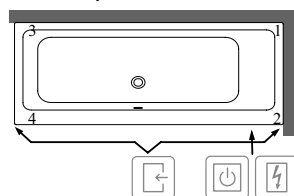

-  Accessible via
-  Control box
-  Rim control

This symbol "O" means this option is possible

XX = Colour code to be indicated

For further information on colours, please see the page at the beginning of this section.

Further information on whirlpool systems please see page 585.

SUBWAY Duo (Rectangle 1800 x 800) Acrylic

€ excl. VAT

Not included in scope of delivery: Set of bath feet is not supplied as standard.
Requires extended waste/overflow combination.

Matching sanitary ceramics: Subway

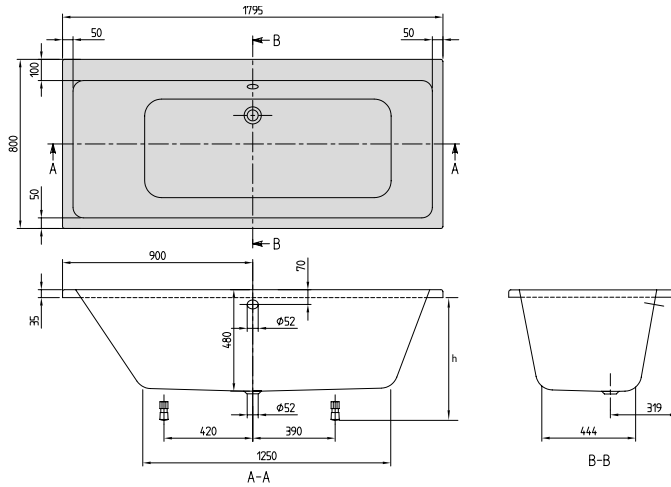

h = Installation height (min - max)	
Bath	585 - 635
Whirlpool system	625 - 665
Profibox 2.0 without system	585 - 585
Profibox 2.0 incl. System	625 - 625

Article number	Description	Size l x w	Bottom l x w	Depth	Litres incl. 1 pers	Weight (kg)	01	pcs/pal.
UBA 180 SUB 2V-XX	Subway	1800 x 800	1250 x 490	480	180	24,5		10

Accessories for baths:

Article number	Description	Price
U99740000	Bath feet, plastic, for baths with even bottom, adjustable from 130 à 180 mm	
U90950461	Multiplex waste/overflow combination, chrome	
UCCON0475	Pipe interruptor, incl. connections	
U90600361	Multiplex Trio Outlet/overflow fitting with water inlet, chrome	
U90600461	Multiplex Trio Outlet/overflow fitting with water inlet and pipe interrupter, chrome	
U90170061	Handgrips, 1 pair = 2 grips, chrome	
U906100XX	Multifunction cushion, foam, 240 x 150 x 50 mm	

Preassembled bath options in combination with: For order form, see fold-out page on the right-hand side	only bath	Airpools		Hydropools		Combipools		Special Combipools	
		AE	AC	HE	HC	CE	CC	IP	AP
Profibox 2.0 alcove	<input type="radio"/>	<input type="radio"/>	<input type="radio"/>	<input type="radio"/>	<input type="radio"/>	<input type="radio"/>	<input type="radio"/>	<input type="radio"/>	-
Profibox 2.0 corner	<input type="radio"/>	<input type="radio"/>	<input type="radio"/>	<input type="radio"/>	<input type="radio"/>	<input type="radio"/>	<input type="radio"/>	<input type="radio"/>	-
TouchLight	<input type="radio"/>	-	-	-	-	-	-	-	-

Whirlpool Systems	Article number	Description	Airpools		Hydropools		Combipools		Special Combipools	
			AE	AC	HE	HC	CE	CC	IP	AP
	U__ 180 SUB 2A ½ V XX	Price of whirlpool system incl. bath								
	U__ 180 SUB 2B ½ V XX	Price of whirlpool system incl. bath incl. Multiplex Trio								

For the following whirlpool systems the technology protrudes:

Technical parts 1	Side 1-3	-	-	-	-	-	-	+10	+20
Technical parts 2	Side 1-3	-	-	-	-	-	-	+10	+20

Please replace __ in article number with whirlpool code.

Please replace ½ in article number with desired position of technical equipment (1 = Layout 1, 2 = Layout 2). The back jets are located at the end at which the technical equipment is installed.

For further options use the order form (see right-hand fold-out page)

Technical parts 1

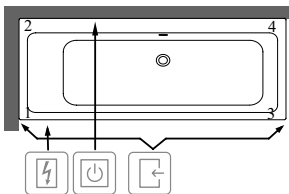

Technical parts 2

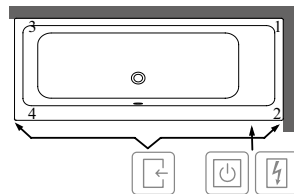

- Accessible via
- Control box
- Rim control

This symbol "O" means this option is possible

XX = Colour code to be indicated

For further information on colours, please see the page at the beginning of this section.

Further information on whirlpool systems please see page 585.

SUBWAY Duo (Rectangle 1900 x 900) Acrylic

€ excl. VAT

Not included in scope of delivery: Set of bath feet is not supplied as standard.
Requires extended waste/overflow combination.

Matching sanitary ceramics: Subway

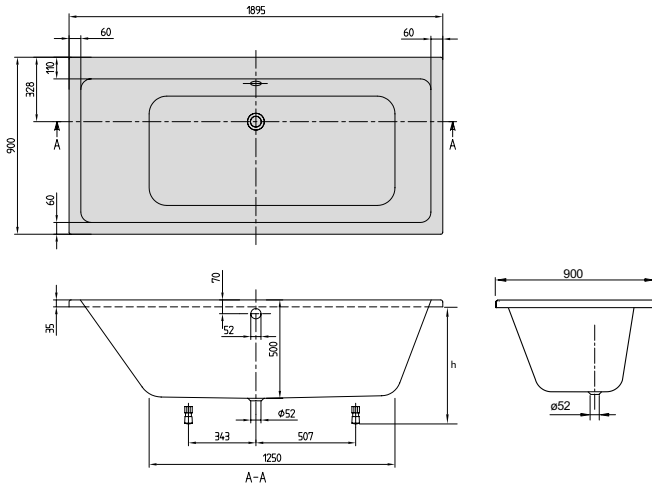

h = Installation height (min - max)	
Bath	605 - 655
Whirlpool system	645 - 685
Profibox 2.0 without system	625 - 625
Profibox 2.0 incl. System	625 - 625

Article number	Description	Size l x w	Bottom l x w	Depth	Litres incl. 1 pers	Weight (kg)	01	pcs/pal.
UBA 199 SUB 2V-XX	Subway	1900 x 900	1250 x 530	500	230	27		10

Accessories for baths:

Article number	Description	Price
U99740000	Bath feet, plastic, for baths with even bottom, adjustable from 130 à 180 mm	
U90950461	Multiplex waste/overflow combination, chrome	
UCCON0475	Pipe interruptor, incl. connections	
U90600361	Multiplex Trio Outlet/overflow fitting with water inlet, chrome	
U90600461	Multiplex Trio Outlet/overflow fitting with water inlet and pipe interrupter, chrome	
U906100XX	Multifunction cushion, foam, 240 x 150 x 50 mm	

Preassembled bath options in combination with: For order form, see fold-out page on the right-hand side	only bath	Airpools		Hydropools		Combipools		Special Combipools	
		AE	AC	HE	HC	CE	CC	IP	AP
Profibox 2.0 alcove	<input type="radio"/>	<input type="radio"/>	<input type="radio"/>	<input type="radio"/>	<input type="radio"/>	<input type="radio"/>	<input type="radio"/>	<input type="radio"/>	-
Profibox 2.0 corner	<input type="radio"/>	<input type="radio"/>	<input type="radio"/>	<input type="radio"/>	<input type="radio"/>	<input type="radio"/>	<input type="radio"/>	<input type="radio"/>	-
TouchLight	<input type="radio"/>	-	-	-	-	-	-	-	-

Whirlpool Systems	Article number	Description	Airpools		Hydropools		Combipools		Special Combipools	
			AE	AC	HE	HC	CE	CC	IP	AP
	U__ 199 SUB 2A ½ V XX	Price of whirlpool system incl. bath								
	U__ 199 SUB 2B ½ V XX	Price of whirlpool system incl. bath incl. Multiplex Trio								

For the following whirlpool systems the technology protrudes:

Technical parts 1	Side 1-3	-	-	-	-	-	-	-	+10
Technical parts 2	Side 1-3	-	-	-	-	-	-	-	+10

Please replace __ in article number with whirlpool code.

Please replace ½ in article number with desired position of technical equipment (1 = Layout 1, 2 = Layout 2). The back jets are located at the end at which the technical equipment is installed.

For further options use the order form (see right-hand fold-out page)

Technical parts 1

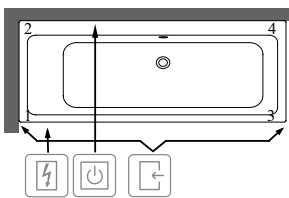

Technical parts 2

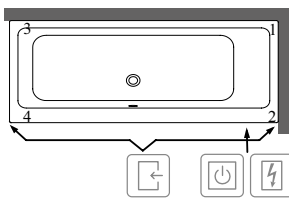

- Accessible via
- Control box
- Rim control

This symbol "O" means this option is possible

XX = Colour code to be indicated

For further information on colours, please see the page at the beginning of this section.

Further information on whirlpool systems please see page 585.

SUBWAY (Corner 1300 x 1300) Acrylic

€ excl. VAT

Not included in scope of delivery:

Set of bath feet is not supplied as standard.
Requires extended waste/overflow combination.
Panel (optionally available, is always pre-installed at the factory). Please note: The panel cannot be retro-fitted.

Technical information:

The height of the panel is 610 mm.
In the case of baths with apron and support set, no bath feet (U99740000) are required.

Matching sanitary ceramics:

Subway

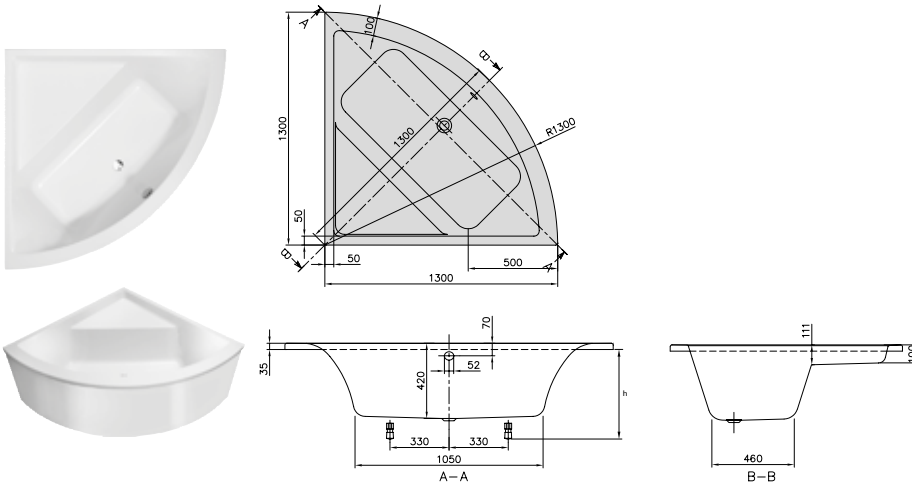

h = Installation height (min - max)	
Bath	525 - 575
Bath with panel	590 - 690
Whirlpool system	595 - 635

Article number	Description	Size l x w	Bottom l x w	Depth	Litres incl. 1 pers	Weight (kg)	01	pcs/pal.
UBA 130 SUB 3V-XX	Subway	1300 x 1300	1050 x 460	420	150	25		5

Accessories for baths:

Article number	Description	Price
U99740000	Bath feet, plastic, for baths with even bottom, adjustable from 130 à 180 mm	
U90950461	Multiplex waste/overflow combination, chrome	
UCCON0475	Pipe interruptor, incl. connections	
U90600361	Multiplex Trio Outlet/overflow fitting with water inlet, chrome	
U90600461	Multiplex Trio Outlet/overflow fitting with water inlet and pipe interruptor, chrome	
U906100XX	Multifunction cushion, foam, 240 x 150 x 50 mm	

Preassembled bath options in combination with: For order form, see fold-out page on the right-hand side	only bath	Airpools		Hydropools		Combipools		Special Combipools	
		AE	AC	HE	HC	CE	CC	IP	AP
Separate panel	<input type="radio"/>	<input type="radio"/>	<input type="radio"/>	<input type="radio"/>	<input type="radio"/>	<input type="radio"/>	<input type="radio"/>	-	-
TouchLight	<input type="radio"/>	-	-	-	-	-	-	-	-

Whirlpool Systems		Airpools		Hydropools		Combipools		Special Combipools	
Article number	Description	AE	AC	HE	HC	CE	CC	IP	AP
U__ 130 SUB 3A ½ V XX	Price of whirlpool system incl. bath								
U__ 130 SUB 3B ½ V XX	Price of whirlpool system incl. bath incl. Multiplex Trio								

For the following whirlpool systems the technology protrudes:

Technical parts 1	Side 1-3	Side 1-4	Side 1-4	Side 3-4
Technical parts 1	-	-	-	-
Technical parts 2	-	-	-	-

Please replace __ in article number with whirlpool code.

Please replace ½ in article number with desired position of technical equipment (1 = Layout 1, 2 = Layout 2). The back jets are located at the end at which the technical equipment is installed.

For further options use the order form (see right-hand fold-out page)

Technical parts 1

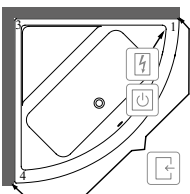

Technical parts 2

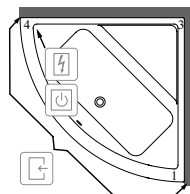

-  Accessible via
-  Control box
-  Rim control

This symbol "O" means this option is possible

XX = Colour code to be indicated

For further information on colours, please see the page at the beginning of this section.

Further information on whirlpool systems please see page 585.

SUBWAY (Offset 1700 x 800) Acrylic

€ excl. VAT

Not included in scope of delivery: Set of bath feet is not supplied as standard.
Matching sanitary ceramics: Subway

BATHS

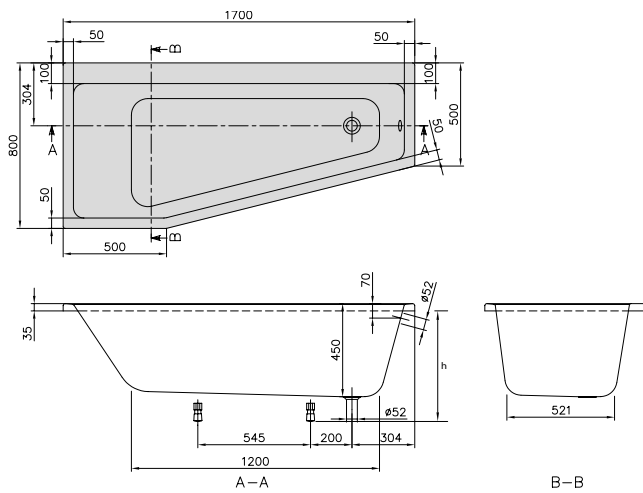

h = Installation height (min - max)	
Bath	555 - 605

Article number	Description	Size l x w	Bottom l x w	Depth	Litres incl. 1 pers	Weight (kg)	01	pcs/pal.
UBA 178 SUB 3LIV-XX	Subway, left	1700 x 800	1200 x 521	450	130	21		10

Accessories for baths:

Article number	Description	Price
U99740000	Bath feet, plastic, for baths with even bottom, adjustable from 130 à 180 mm	
U90950461	Multiplex waste/overflow combination, chrome	
UCCON0475	Pipe interruptor, incl. connections	
U90600361	Multiplex Trio Outlet/overflow fitting with water inlet, chrome	
U90600461	Multiplex Trio Outlet/overflow fitting with water inlet and pipe interruptor, chrome	
U90170061	Handgrips, 1 pair = 2 grips, chrome	
U906100XX	Multifunction cushion, foam, 240 x 150 x 50 mm	

XX = Colour code to be indicated
 For further information on colours, please see the page at the beginning of this section.
 Further information on whirlpool systems please see page 585.

SUBWAY (Offset 1700 x 800) Acrylic

€ excl. VAT

Not included in scope of delivery: Set of bath feet is not supplied as standard.
Matching sanitary ceramics: Subway

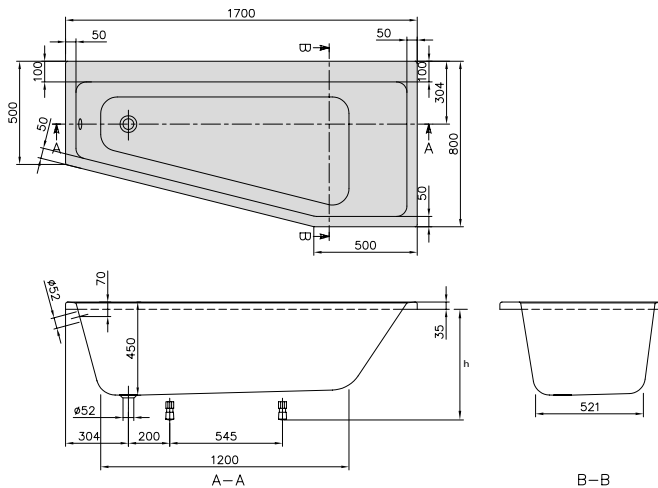

h = Installation height (min - max)	
Bath	555 - 605

Article number	Description	Size l x w	Bottom l x w	Depth	Litres incl. 1 pers	Weight (kg)	01	pcs/pal.
UBA 178 SUB 3REV-XX	Subway, right	1700 x 800	1200 x 521	450	130	21		10

Accessories for baths:

Article number	Description	Price
U99740000	Bath feet, plastic, for baths with even bottom, adjustable from 130 à 180 mm	
U90950461	Multiplex waste/overflow combination, chrome	
UCCON0475	Pipe interruptor, incl. connections	
U90600361	Multiplex Trio Outlet/overflow fitting with water inlet, chrome	
U90600461	Multiplex Trio Outlet/overflow fitting with water inlet and pipe interrupter, chrome	
U90170061	Handgrips, 1 pair = 2 grips, chrome	
U906100XX	Multifunction cushion, foam, 240 x 150 x 50 mm	

XX = Colour code to be indicated
 For further information on colours, please see the page at the beginning of this section.
 Further information on whirlpool systems please see page 585.

SUBWAY Duo (Hexagonal 1900 x 800) Acrylic

€ excl. VAT

Not included in scope of delivery: Set of bath feet is not supplied as standard. Requires extended waste/overflow combination.

Technical information: In case of corner installation the diagonal dimension is 1344 mm.

Matching sanitary ceramics: Subway

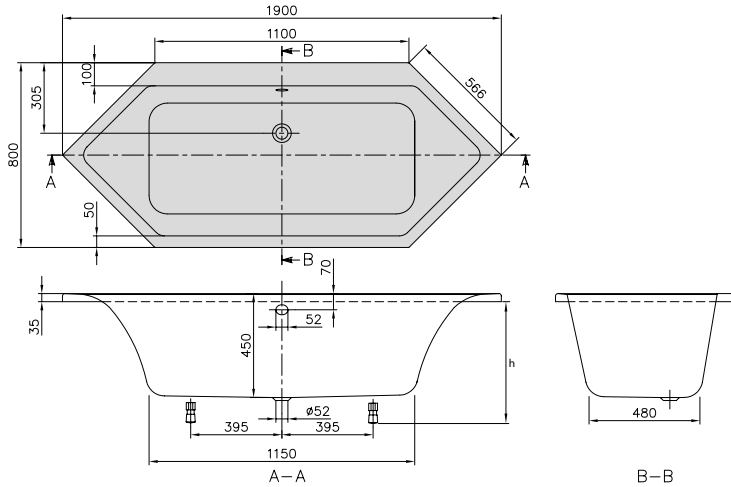

h = Installation height (min - max)	
Bath	555 - 605
Whirlpool system	595 - 635

Article number	Description	Size l x w	Bottom l x w	Depth	Litres incl. 1 pers	Weight (kg)	01	pcs/pal.
UBA 190 SUB 6V-XX	Subway	1900 x 800	1150 x 480	450	145	23		10

Accessories for baths:

Article number	Description	Price
U99740000	Bath feet, plastic, for baths with even bottom, adjustable from 130 à 180 mm	
U90950461	Multiplex waste/overflow combination, chrome	
UCCON0475	Pipe interruptor, incl. connections	
U90600361	Multiplex Trio Outlet/overflow fitting with water inlet, chrome	
U90600461	Multiplex Trio Outlet/overflow fitting with water inlet and pipe interruptor, chrome	
U90170061	Handgrips, 1 pair = 2 grips, chrome	
U906100XX	Multifunction cushion, foam, 240 x 150 x 50 mm	

Preassembled bath options in combination with:

For order form, see fold-out page on the right-hand side

	only bath	Airpools		Hydropools		Combipools		Special Combipools	
		AE	AC	HE	HC	CE	CC	IP	AP
TouchLight	○	-	-	-	-	-	-	-	-

Whirlpool Systems

Article number	Description	Airpools		Hydropools		Combipools		Special Combipools	
		AE	AC	HE	HC	CE	CC	IP	AP
U__ 190 SUB 6A ½ V XX	Price of whirlpool system incl. bath								
U__ 190 SUB 6B ½ V XX	Price of whirlpool system incl. bath incl. Multiplex Trio								

For the following whirlpool systems the technology protrudes:

Technical parts	Side	Airpools		Hydropools		Combipools		Special Combipools	
		AE	AC	HE	HC	CE	CC	IP	AP
Technical parts 1	Side 1-3	-	-	-	-	-	-	-	+10
	Side 3-6	-	-	-	-	-	-	-	+15
	Side 4-6	-	-	-	-	-	-	-	+15
Technical parts 2	Side 1-3	-	-	-	-	-	-	-	+10
	Side 1-5	-	-	-	-	-	-	-	+15
	Side 2-5	-	-	-	-	-	-	-	+15

Please replace __ in article number with whirlpool code.

Please replace ½ in article number with desired position of technical equipment (1 = Layout 1, 2 = Layout 2). The back jets are located at the end at which the technical equipment is installed.

For further options use the order form (see right-hand fold-out page)

Technical parts 1

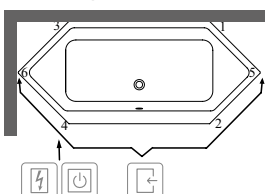

Technical parts 2

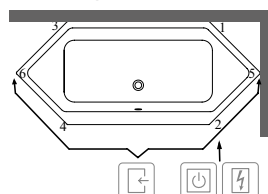

- Accessible via
- Control box
- Rim control

This symbol "○" means this option is possible

XX = Colour code to be indicated

For further information on colours, please see the page at the beginning of this section.

Further information on whirlpool systems please see page 585.

SUBWAY 3.0 BATH

€ excl. VAT

Quaryl® built-in bath with long overflow hole and optional SilentFlow bath filler



- Modern design in keeping with today's interior trends thanks to the thin edge along the backrest, the greater bath depth and a rim height of just 10 mm.
- The bath depth of 48 cm is significantly more comfortable.
- The Subway 3.0 bath has generous inner dimensions. It combines timeless design with real reclining comfort.
- The first Villeroy & Boch bath with a wide overflow
- Optimum SilentFlow fills the bath from below, which makes a separate water inlet superfluous and improves the overall appearance of the bath.
- Also available with whirlpool systems
- Matching ceramics and furniture programme Subway 3.0

BATHS

Individual combination possibilities



The first Villeroy & Boch Quaryl® bath with a wide overflow and a flush-fitting, integral Push-to-Open outlet valve, for a stylish look.



The particularly modern, wide overflow is available in glossy chrome or in White Alpin, Stone White and Black Matt to match the contemporary tap fittings

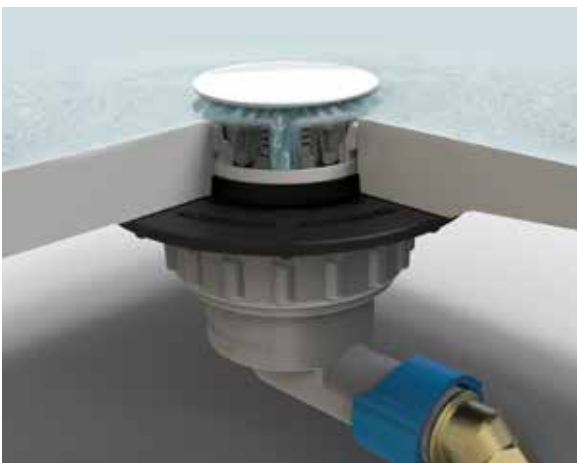

SilentFlow is a bath filler concealed within the base of the bath. SilentFlow is stylish and flush-fitting. Available in White Alpin or Stone White. The bath is filled at a rate of 20 litres / minute. Innovative and a special highlight in state-of the art bathroom design

Bath colours



01 White Alpine



RW Stone White

Accessory colours



White Alpin



Chrome



Stone White



Black Matt

SUBWAY 3.0 Duo (Rectangle 1700 x 750) Quarryl®

NEW

€ excl. VAT

Included in scope of delivery:

Matching outlet and overflow (Chrome) is supplied as standard. The outlet cover matches the colour of the bath.
The overflow is chrome-plated.

Not included in scope of delivery:

Set of bath feet is supplied as standard (self-adhesive), adjustable from 130 à 180 mm.
Overflow in Black Matt, Overflow in Stone White
This option is without an outlet cover.

Technical information:

Note: There is no space for a tap hole behind the overflow.
2 holes are possible to the left or right respectively of the overflow hole

Matching sanitary ceramics:

Subway 3.0

Matching furniture programme:

Subway 3.0

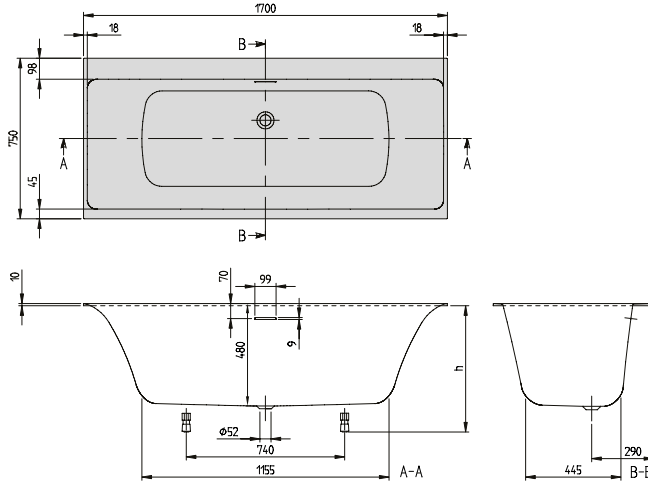

Quarryl®

h = Installation height (min - max)	
Bath	610 - 660
Whirlpool system	645 - 680
Profibox 2.0 without system	625 - 625

Article number	Description	Size l x w	Bottom l x w	Depth	Litres incl. 1 pers	Weight (kg)	01	RW	pcs/pat.
UBQ 170 SBW 2DV-XX	Subway 3.0	1700 x 750	1155 x 445	480	183	42			8

Accessories for baths:

Article number	Description	Price
UCCON0475	Pipe interruptor, incl. connections	
U90170061	Handgrips, 1 pair = 2 grips, chrome	
U906100XX	Multifunction cushion, foam, 240 x 150 x 50 mm	
U909580RW	Overflow, Stone White (NEW)	
U90958033	Overflow, Black Matt (NEW)	
U90958001	Overflow, white (alpin) (NEW)	

Preassembled bath options in combination with:

For order form, see fold-out page on the right-hand side

	only bath	Airpools		Hydropools		Combipools		Special Combipools	
		AE	AC	HE	HC	CE	CC	IP	AP
Profibox 2.0 alcove	<input type="radio"/>	<input type="radio"/>	<input type="radio"/>	<input type="radio"/>	<input type="radio"/>	<input type="radio"/>	<input type="radio"/>	<input type="radio"/>	<input type="radio"/>
TouchLight	<input type="radio"/>	-	-	-	-	-	-	-	-

Whirlpool Systems

Article number	Description	Airpools		Hydropools		Combipools		Special Combipools	
		AE	AC	HE	HC	CE	CC	IP	AP
U__ 170 SBW 2A ½ V 01	Price of whirlpool system incl. bath								
U__ 170 SBW 2A ½ V RW	Price of whirlpool system incl. bath								

For the following whirlpool systems the technology protrudes:

Technical parts	Side 1-3	Side 3-4	Side 1-2	Side 1-3
Technical parts 1	-	-	-	-
Technical parts 2	-	-	-	-

Please replace __ in article number with whirlpool code.

Please replace ½ in article number with desired position of technical equipment (1 = Layout 1, 2 = Layout 2). The back jets are located at the end at which the technical equipment is installed.

For further options use the order form (see right-hand fold-out page)

Technical parts 1

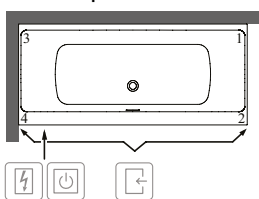

Technical parts 2

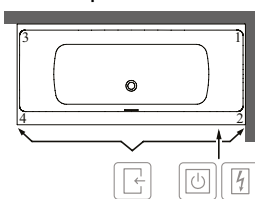

- Accessible via
- Control box
- Rim control

This symbol "O" means this option is possible

XX = Colour code to be indicated

For further information on colours, please see the page at the beginning of this section.

Further information on whirlpool systems please see page 585.

SUBWAY 3.0 Duo with SilentFlow (Rectangle 1700 x 750) Quarry!

NEW

€ excl. VAT

Included in scope of delivery:

Matching outlet and overflow (Chrome) is supplied as standard. The outlet cover matches the colour of the bath.
 The overflow is chrome-plated.
 Set of bath feet is supplied as standard (self-adhesive), adjustable from 130 à 180 mm.
 Quiet filling of the bath tub with the "SilentFlow" feature in the base of the bath. This cannot be ordered at a later date!

Not included in scope of delivery:

Overflow in Black Matt, Overflow in Stone White
 This option is without an outlet cover.

Technical information:

Note: There is no space for a tap hole behind the overflow.
 2 holes are possible to the left or right respectively of the overflow hole

Matching sanitary ceramics:

Subway 3.0

Matching furniture programme:

Subway 3.0

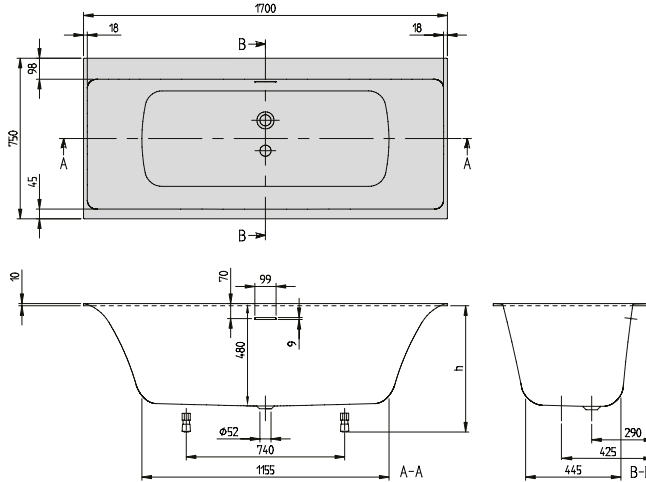

Quarry!

h = Installation height (min - max)	
Bath	610 - 660
Whirlpool system	645 - 680
Profibox 2.0 without system	625 - 625

Article number	Description	Size l x w	Bottom l x w	Depth	Litres incl. 1 pers	Weight (kg)	01	RW	pcs/pal.
UBQ 170 SBW 2TDV-XX	Subway 3.0, incl. SilentFlow bath filler	1700 x 750	1155 x 445	480	183	42			8

Accessories for baths:

Article number	Description	Price
UCCON0475	Pipe interruptor, incl. connections	
U90170061	Handgrips, 1 pair = 2 grips, chrome	
U906100XX	Multifunction cushion, foam, 240 x 150 x 50 mm	
U909580RW	Overflow, Stone White (NEW)	
U90958033	Overflow, Black Matt (NEW)	
U90958001	Overflow, white (alpin) (NEW)	

Preassembled bath options in combination with:

For order form, see fold-out page on the right-hand side

	only bath	Airpools		Hydropools		Combipools		Special Combipools	
		AE	AC	HE	HC	CE	CC	IP	AP
Profibox 2.0 alcove	○	○	○	○	○	○	○	○	-
TouchLight	○	-	-	-	-	-	-	-	-

Whirlpool Systems

Article number	Description	Airpools		Hydropools		Combipools		Special Combipools	
		AE	AC	HE	HC	CE	CC	IP	AP
U__ 170 SBW 2B ½ V 01	Price of whirlpool system incl. bath incl. SilentFlow								
U__ 170 SBW 2B ½ V RW	Price of whirlpool system incl. bath incl. SilentFlow								

For the following whirlpool systems the technology protrudes:

Technical parts 1	Side 1-3	Side 3-4	Side 1-2	Side 1-3					
	-	-	-	-	-	-	-	-	+15
	-	-	-	-	-	-	-	-	+5
Technical parts 2	-	-	-	-	-	-	-	-	+5
	-	-	-	-	-	-	-	-	+15

Please replace __ in article number with whirlpool code.

Please replace ½ in article number with desired position of technical equipment (1 = Layout 1, 2 = Layout 2). The back jets are located at the end at which the technical equipment is installed.

For further options use the order form (see right-hand fold-out page)

Technical parts 1

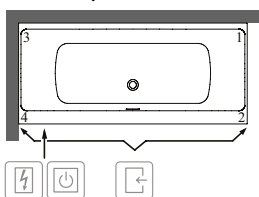

Technical parts 2

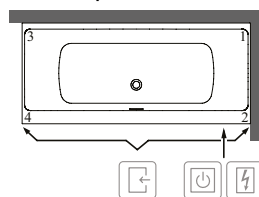

- Accessible via
- Control box
- Rim control

This symbol "○" means this option is possible

XX = Colour code to be indicated

For further information on colours, please see the page at the beginning of this section.

Further information on whirlpool systems please see page 585.

SUBWAY 3.0 Duo (Rectangle 1800 x 800) Quarryl®

NEW

€ excl. VAT

Included in scope of delivery:

Matching outlet and overflow (Chrome) is supplied as standard. The outlet cover matches the colour of the bath. The overflow is chrome-plated.

Not included in scope of delivery:

Set of bath feet is supplied as standard (self-adhesive), adjustable from 130 à 180 mm. Overflow in Black Matt, Overflow in Stone White. This option is without an outlet cover.

Technical information:

Note: There is no space for a tap hole behind the overflow. 2 holes are possible to the left or right respectively of the overflow hole

Matching sanitary ceramics:

Subway 3.0

Matching furniture programme:

Subway 3.0

BATHS

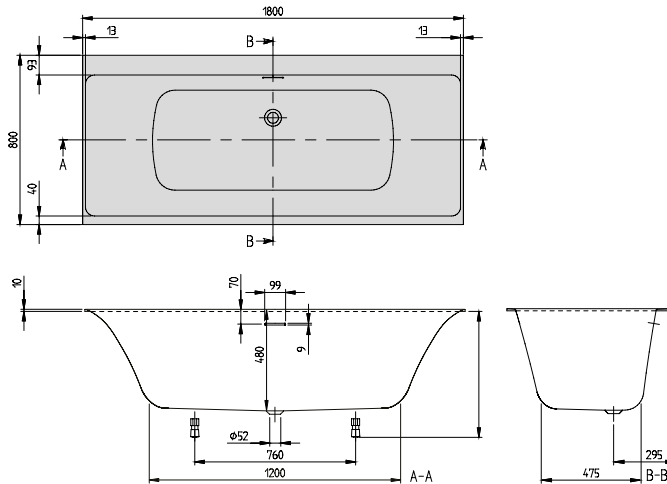

Quarryl®

h = Installation height (min - max)	
Bath	610 - 660
Whirlpool system	645 - 680
Profibox 2.0 without system	625 - 625

Article number	Description	Size l x w	Bottom l x w	Depth	Litres incl. 1 pers	Weight (kg)	01	RW	pcs/pat.
UBQ 180 SBW 2DV-XX	Subway 3.0	1800 x 800	1200 x 475	480	219	44			8

Accessories for baths:

Article number	Description	Price
UCCON0475	Pipe interruptor, incl. connections	
U90170061	Handgrips, 1 pair = 2 grips, chrome	
U906100XX	Multifunction cushion, foam, 240 x 150 x 50 mm	
U909580RW	Overflow, Stone White (NEW)	
U90958033	Overflow, Black Matt (NEW)	
U90958001	Overflow, white (alpin) (NEW)	

Preassembled bath options in combination with:		Airpools		Hydropools		Combipools		Special Combipools	
For order form, see fold-out page on the right-hand side		AE	AC	HE	HC	CE	CC	IP	AP
Profibox 2.0 alcove	<input type="radio"/>	<input type="radio"/>	<input type="radio"/>	<input type="radio"/>	<input type="radio"/>	<input type="radio"/>	<input type="radio"/>	<input type="radio"/>	<input type="radio"/>
TouchLight	<input type="radio"/>	-	-	-	-	-	-	-	-

Whirlpool Systems		Airpools		Hydropools		Combipools		Special Combipools	
Article number	Description	AE	AC	HE	HC	CE	CC	IP	AP
U__ 180 SBW 2A ½ V 01	Price of whirlpool system incl. bath								
U__ 180 SBW 2A ½ V RW	Price of whirlpool system incl. bath								

For the following whirlpool systems the technology protrudes:

Technical parts 1	Side 1-3	-	-	-	-	-	-	-	+5
Technical parts 2	Side 1-3	-	-	-	-	-	-	-	+5

Please replace __ in article number with whirlpool code.

Please replace ½ in article number with desired position of technical equipment (1 = Layout 1, 2 = Layout 2). The back jets are located at the end at which the technical equipment is installed.

For further options use the order form (see right-hand fold-out page)

Technical parts 1

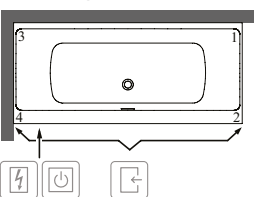

Technical parts 2

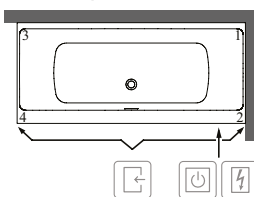

- Accessible via
- Control box
- Rim control

This symbol "O" means this option is possible

XX = Colour code to be indicated

For further information on colours, please see the page at the beginning of this section.

Further information on whirlpool systems please see page 585.

SUBWAY 3.0 Duo with SilentFlow (Rectangle 1800 x 800) Quarry!

NEW

€ excl. VAT

Included in scope of delivery:

Matching outlet and overflow (Chrome) is supplied as standard. The outlet cover matches the colour of the bath.
The overflow is chrome-plated.
Set of bath feet is supplied as standard (self-adhesive), adjustable from 130 à 180 mm.
Quiet filling of the bath tub with the "SilentFlow" feature in the base of the bath. This cannot be ordered at a later date!

Not included in scope of delivery:

Overflow in Black Matt, Overflow in Stone White
This option is without an outlet cover.

Technical information:

Note: There is no space for a tap hole behind the overflow.
2 holes are possible to the left or right respectively of the overflow hole

Matching sanitary ceramics:

Subway 3.0

Matching furniture programme:

Subway 3.0

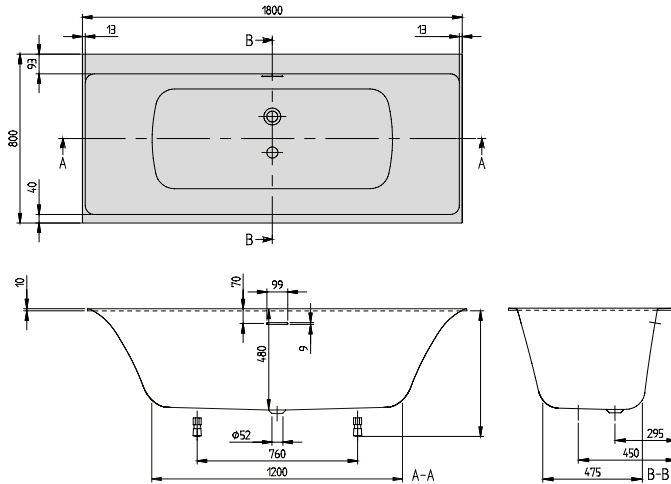

Quarry!

h = Installation height (min - max)	
Bath	610 - 660
Whirlpool system	645 - 680
Profibox 2.0 without system	625 - 625

Article number	Description	Size l x w	Bottom l x w	Depth	Litres incl. 1 pers	Weight (kg)	01	RW	pcs/pal.
UBQ 180 SBW 2TDV-XX	Subway 3.0, incl. SilentFlow bath filler	1800 x 800	1200 x 475	480	219	44			8

Accessories for baths:

Article number	Description	Price
UCCON0475	Pipe interruptor, incl. connections	
U90170061	Handgrips, 1 pair = 2 grips, chrome	
U906100XX	Multifunction cushion, foam, 240 x 150 x 50 mm	
U909580RW	Overflow, Stone White (NEW)	
U90958033	Overflow, Black Matt (NEW)	
U90958001	Overflow, white (alpin) (NEW)	

Preassembled bath options in combination with:

For order form, see fold-out page on the right-hand side

	only bath	Airpools		Hydropools		Combipools		Special Combipools	
		AE	AC	HE	HC	CE	CC	IP	AP
Profibox 2.0 alcove	○	○	○	○	○	○	○	○	-
TouchLight	○	-	-	-	-	-	-	-	-

Whirlpool Systems

Article number	Description	Airpools		Hydropools		Combipools		Special Combipools	
		AE	AC	HE	HC	CE	CC	IP	AP
U__ 180 SBW 2B ½ V 01	Price of whirlpool system incl. bath incl. SilentFlow								
U__ 180 SBW 2B ½ V RW	Price of whirlpool system incl. bath incl. SilentFlow								

For the following whirlpool systems the technology protrudes:

Technical parts 1	Side 1-3	-	-	-	-	-	-	-	+5
Technical parts 2	Side 1-3	-	-	-	-	-	-	-	+5

Please replace __ in article number with whirlpool code.

Please replace ½ in article number with desired position of technical equipment (1 = Layout 1, 2 = Layout 2). The back jets are located at the end at which the technical equipment is installed.

For further options use the order form (see right-hand fold-out page)

Technical parts 1

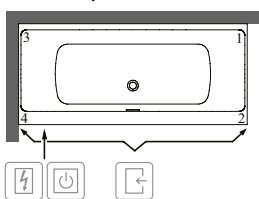

Technical parts 2

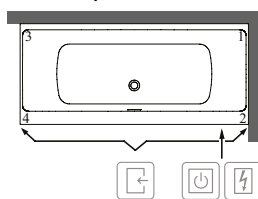

- Accessible via
- Control box
- Rim control

This symbol "○" means this option is possible

XX = Colour code to be indicated

For further information on colours, please see the page at the beginning of this section.

Further information on whirlpool systems please see page 585.

BATHS

THEANO Solo (Free-standing 1550 x 750) Quarryl®

€ excl. VAT

Not included in scope of delivery:

Push-to-Open valve without overflow function and ViFlow.

Technical information:

Please note: In accordance with DIN 1986-100, a floor drain is required to protect the building against flooding, if a bath is installed without an overflow. No floor drain is required if ViFlow is used.

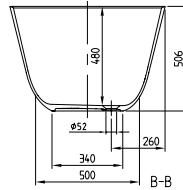
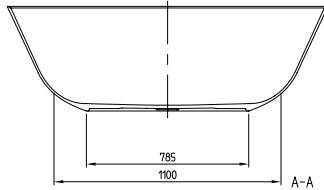
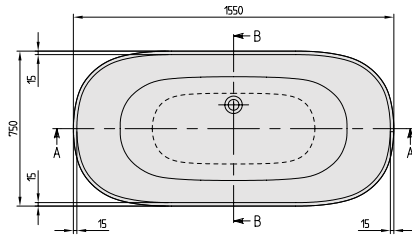

Article number	Description	Size l x w	Bottom l x w	Depth	Litres incl. 1 pers	Weight (kg)	01	RW	pcs/pal.
UBQ 155 ANH 7F200V-XX	Theano, freestanding	1550 x 750	1100 x 500	480	250	49,4			1

Accessories for baths:

Article number	Description	Price
U906100XX	Multifunction cushion, foam, 240 x 150 x 50 mm	
U90952061	Push-to-Open valve without overflow function (Outlet cover White & Chrome), chrome	
U909520RW	Push-to-Open valve without overflow function (Outlet cover White & Chrome), Stone White (NEW)	
U90952033	Push-to-Open valve without overflow function (Outlet cover White & Chrome), Black Matt (NEW)	
U90953061	ViFlow, Outlet and overflow fittings without an overflow, chrome	
U90953068	ViFlow, Outlet and overflow fittings without an overflow, White	
U909530RW	ViFlow, Outlet and overflow fittings without an overflow, Stone White (NEW)	
U90953033	ViFlow, Outlet and overflow fittings without an overflow, Black Matt (NEW)	

XX = Colour code to be indicated

For further information on colours, please see the page at the beginning of this section.

Further information on whirlpool systems please see page 585.

THEANO Solo (Free-standing 1550 x 750) Quarryl®, Colour on Demand

€ excl. VAT

Not included in scope of delivery:

Push-to-Open valve without overflow function and ViFlow.

Technical information:

Please note: In accordance with DIN 1986-100, a floor drain is required to protect the building against flooding, if a bath is installed without an overflow. No floor drain is required if ViFlow is used.

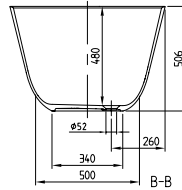
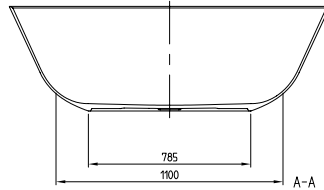
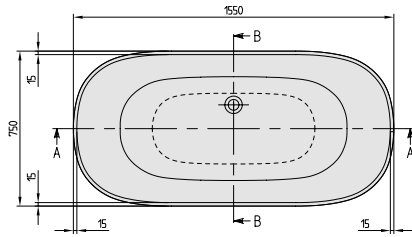

BATHS

Article number	Description	Size l x w	Bottom l x w	Depth	Litres incl. 1 pers	Weight (kg)	01	RW	pcs/pal.
UBQ 155 ANH 7F2BCV-XX	Theano, freestanding, Colour on Demand (Quaryl®)	1550 x 750	1100 x 500	480	250	49,4			1

Accessories for baths:

Article number	Description	Price
U906100XX	Multifunction cushion, foam, 240 x 150 x 50 mm	
U90952061	Push-to-Open valve without overflow function (Outlet cover White & Chrome), chrome	
U909520RW	Push-to-Open valve without overflow function (Outlet cover White & Chrome), Stone White (NEW)	
U90952033	Push-to-Open valve without overflow function (Outlet cover White & Chrome), Black Matt (NEW)	
U90953061	ViFlow, Outlet and overflow fittings without an overflow, chrome	
U90953068	ViFlow, Outlet and overflow fittings without an overflow, White	
U909530RW	ViFlow, Outlet and overflow fittings without an overflow, Stone White (NEW)	
U90953033	ViFlow, Outlet and overflow fittings without an overflow, Black Matt (NEW)	

Made-to-order production - Colour on Demand: 3 week delivery period. Please make sure to use the **order form** that you will find immediately after the chapter on baths on page 578-579, so that we can complete the order for you.

XX = Colour code to be indicated
 For further information on colours, please see the page at the beginning of this section.
 Further information on whirlpool systems please see page 585.

THEANO Duo (Free-standing 1750 x 800) Quarry®

€ excl. VAT

Not included in scope of delivery:

Push-to-Open valve without overflow function and ViFlow.

Technical information:

Please note: In accordance with DIN 1986-100, a floor drain is required to protect the building against flooding, if a bath is installed without an overflow. No floor drain is required if ViFlow is used.

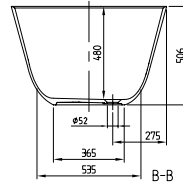
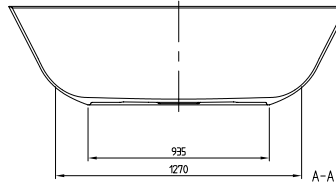
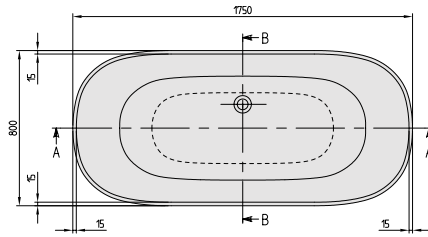

Article number	Description	Size l x w	Bottom l x w	Depth	Litres incl. 1 pers	Weight (kg)	01	RW	pcs/pal.
UBQ 175 ANH 7F200V-XX	Theano, freestanding	1750 x 800	1270 x 535	480	315	75,9			1

Accessories for baths:

Article number	Description	Price
U906100XX	Multifunction cushion, foam, 240 x 150 x 50 mm	
U90952061	Push-to-Open valve without overflow function (Outlet cover White & Chrome), chrome	
U909520RW	Push-to-Open valve without overflow function (Outlet cover White & Chrome), Stone White (NEW)	
U90952033	Push-to-Open valve without overflow function (Outlet cover White & Chrome), Black Matt (NEW)	
U90953061	ViFlow, Outlet and overflow fittings without an overflow, chrome	
U90953068	ViFlow, Outlet and overflow fittings without an overflow, White	
U909530RW	ViFlow, Outlet and overflow fittings without an overflow, Stone White (NEW)	
U90953033	ViFlow, Outlet and overflow fittings without an overflow, Black Matt (NEW)	

XX = Colour code to be indicated

For further information on colours, please see the page at the beginning of this section.

Further information on whirlpool systems please see page 585.

THEANO Duo (Free-standing 1750 x 800) Quarryl®, Colour on Demand

€ excl. VAT

Not included in scope of delivery:

Push-to-Open valve without overflow function and ViFlow.

Technical information:

Please note: In accordance with DIN 1986-100, a floor drain is required to protect the building against flooding, if a bath is installed without an overflow. No floor drain is required if ViFlow is used.

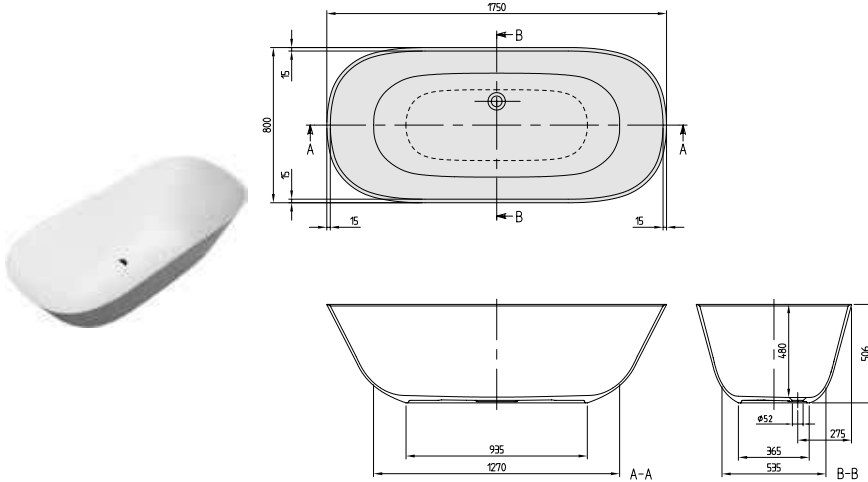

BATHS

Article number	Description	Size l x w	Bottom l x w	Depth	Litres incl. 1 pers	Weight (kg)	01	RW	pcs/pal.
UBQ 175 ANH 7F2BCV-XX	Theano, freestanding, Colour on Demand (Quarryl®)	1750 x 800	1270 x 535	480	315	75,9			1

Accessories for baths:

Article number	Description	Price
U906100XX	Multifunction cushion, foam, 240 x 150 x 50 mm	
U90952061	Push-to-Open valve without overflow function (Outlet cover White & Chrome), chrome	
U909520RW	Push-to-Open valve without overflow function (Outlet cover White & Chrome), Stone White (NEW)	
U90952033	Push-to-Open valve without overflow function (Outlet cover White & Chrome), Black Matt (NEW)	
U90953061	ViFlow, Outlet and overflow fittings without an overflow, chrome	
U90953068	ViFlow, Outlet and overflow fittings without an overflow, White	
U909530RW	ViFlow, Outlet and overflow fittings without an overflow, Stone White (NEW)	
U90953033	ViFlow, Outlet and overflow fittings without an overflow, Black Matt (NEW)	

Made-to-order production - Colour on Demand: 3 week delivery period. Please make sure to use the **order form** that you will find immediately after the chapter on baths on page 578-579, so that we can complete the order for you.

XX = Colour code to be indicated
 For further information on colours, please see the page at the beginning of this section.
 Further information on whirlpool systems please see page 585.

COLOUR ON DEMAND

€ excl. VAT

BATHTUBS COLOUR ON DEMAND

FINE FORMS. STRONG COLOURS.

Colours arouse emotions, create atmosphere and lend the bathroom a distinctive personality. Offering a unique variety of colours, the free-standing Villeroy & Boch bathtubs are an absolute highlight in any bathroom.

Design hit

- Available for free-standing models Antheus, Collaro, Finion, La Belle, Squaro Edge 12, Theano and Loop & Friends (oval and rectangular design), as well as Aveo New Generation, La Belle Excellence and Squaro Excellence
- Also available for wall-facing models Collaro and Oberon 2.0
- Optimum comfort thanks to acrylic and Quaryl®
- High quality coating of the bathtub panels
- With a free-standing bathtub, you choose where you want the bathtub to be - whether in the middle of the room or right next to the window
- From 2020 you can select the colour Stone White as the interior colour for some models. Please complete the order form and tick which interior colour is required.

Colour highlights

- Free-standing bathtubs in Bicolour look
- Award winning – a completely new spectrum of design options
- Offered in the 9 shades of the colour concept developed by Gesa Hansen and inspired by the seasons in Paris
- Additionally available in accordance with the colour systems: RAL, Pantone and Sikkens (except for metallic colours and colours with RAL pearl finish)
- UV-resistant



Due to the different materials used, there may be variations in colour between the images and the actual products.

ORDER FORM FOR BATHS WITH COLOUR ON DEMAND

€ excl. VAT

Wholesaler order number:

Name:

Contact person:

Postal code, town/city:

Address:

Fax:

Tel. no.:

Signature:

Follow these 2 steps:

Step 1: The bath

Choose your favourite Villeroy & Boch bath (please tick):

	Article number	Description	Page	01	RW
<input type="checkbox"/>	UBQ 155 ANH 7F4BCV-XX	Antheus, freestanding, Colour on Demand (Quaryl®)	456		
<input type="checkbox"/>	UBQ 175 ANH 7F4BCV-XX	Antheus, freestanding, Colour on Demand (Quaryl®)	458		
<input type="checkbox"/>	UBQ 194 AVE 9W1BCV-XX	Aveo New Generation, freestanding, seamless, Colour on Demand (Quaryl®), incl. pre-fitted outlet and overflow (chrome plated)	470		
<input type="checkbox"/>	UBQ 194 AVE 9T1BCV-XX	Aveo New Generation, freestanding, seamless, Colour on Demand (Quaryl®), incl. pre-fitted Multiplex Trio (chrome plated)	470		
<input type="checkbox"/>	UBA 180 COR 9CSBCVN XX	Collaro, wall-facing, Colour on Demand, seamless, Black Matt	484		
<input type="checkbox"/>	UBA 180 COR 9CSBCVJ XX	Collaro, wall-facing, Colour on Demand, seamless, Gold	484		
<input type="checkbox"/>	UBA 180 COR 9CSBCVE XX	Collaro, wall-facing, Colour on Demand, seamless, Champagne	484		
<input type="checkbox"/>	UBA 180 COR 9CSBCVD XX	Collaro, wall-facing, Colour on Demand, seamless, Chrome	484		
<input type="checkbox"/>	UBA 180 COR 9CRBCVN XX	Collaro, wall-facing, corner version right, Colour on Demand, Black Matt	482		
<input type="checkbox"/>	UBA 180 COR 9CRBCVJ XX	Collaro, wall-facing, corner version right, Colour on Demand, Gold	482		
<input type="checkbox"/>	UBA 180 COR 9CRBCVE XX	Collaro, wall-facing, corner version right, Colour on Demand, Champagne	482		
<input type="checkbox"/>	UBA 180 COR 9CRBCVD XX	Collaro, wall-facing, corner version right, Colour on Demand, Chrome	482		
<input type="checkbox"/>	UBA 180 COR 9CLBCVN XX	Collaro, wall-facing, corner version left, Black Matt	480		
<input type="checkbox"/>	UBA 180 COR 9CLBCVJ XX	Collaro, wall-facing, corner version left, Gold	480		
<input type="checkbox"/>	UBA 180 COR 9CLBCVE XX	Collaro, wall-facing, corner version left, Champagne	480		
<input type="checkbox"/>	UBA 180 COR 9CLBCVD XX	Collaro, wall-facing, corner version left, Chrome	480		
<input type="checkbox"/>	UBQ 177 FIN 7A1BCV2 XX	Finion, freestanding, seamless, Colour on Demand (Quaryl®), incl. factory-fitted Push-to-Open valve and overflow, design ring, Chrome	490		
<input type="checkbox"/>	UBQ 177 FIN 7N1BCV2 XX	Finion, freestanding, seamless, Colour on Demand (Quaryl®), incl. factory-fitted Push-to-Open valve, overflow and water inlet, design ring, Chrome	490		
<input type="checkbox"/>	UBQ 177 FIN 7A1BCV1 XX	Finion, freestanding, seamless, Colour on Demand (Quaryl®), incl. factory-fitted Push-to-Open valve and overflow, design ring and Emotion feature, Chrome	490		
<input type="checkbox"/>	UBQ 177 FIN 7N1BCV1 XX	Finion, freestanding, seamless, Colour on Demand (Quaryl®), incl. factory-fitted Push-to-Open valve, overflow and water inlet, design ring and Emotion feature, Chrome	490		
<input type="checkbox"/>	UBQ 177 FIN 7A1BCV4 XX	Finion, freestanding, seamless, Colour on Demand (Quaryl®), incl. factory-fitted Push-to-Open valve and overflow, Chrome	490		
<input type="checkbox"/>	UBQ 177 FIN 7N1BCV4 XX	Finion, freestanding, seamless, Colour on Demand (Quaryl®), incl. factory-fitted Push-to-Open valve, overflow and water inlet, Chrome	490		
<input type="checkbox"/>	UBQ 177 FIN 7A1BCV3 XX	Finion, freestanding, seamless, Colour on Demand (Quaryl®), incl. factory-fitted Push-to-Open valve and overflow, Emotion feature, Chrome	490		
<input type="checkbox"/>	UBQ 177 FIN 7N1BCV3 XX	Finion, freestanding, seamless, Colour on Demand (Quaryl®), incl. factory-fitted Push-to-Open valve, overflow and water inlet, Emotion feature, Chrome	490		
<input type="checkbox"/>	UBQ 177 FIN 7A2BCV2 XX	Finion, freestanding, seamless, Colour on Demand (Quaryl®), incl. factory-fitted Push-to-Open valve and overflow, design ring, Champagne	491		
<input type="checkbox"/>	UBQ 177 FIN 7N2BCV2 XX	Finion, freestanding, seamless, Colour on Demand (Quaryl®), incl. factory-fitted Push-to-Open valve, overflow and water inlet, design ring, Champagne	491		
<input type="checkbox"/>	UBQ 177 FIN 7A2BCV1 XX	Finion, freestanding, seamless, Colour on Demand (Quaryl®), incl. factory-fitted Push-to-Open valve and overflow, design ring and Emotion feature, Champagne	491		
<input type="checkbox"/>	UBQ 177 FIN 7N2BCV1 XX	Finion, freestanding, seamless, Colour on Demand (Quaryl®), incl. factory-fitted Push-to-Open valve, overflow and water inlet, design ring and Emotion feature, Champagne	491		
<input type="checkbox"/>	UBQ 177 FIN 7A2BCV4 XX	Finion, freestanding, seamless, Colour on Demand (Quaryl®), incl. factory-fitted Push-to-Open valve and overflow, Champagne	491		
<input type="checkbox"/>	UBQ 177 FIN 7N2BCV4 XX	Finion, freestanding, seamless, Colour on Demand (Quaryl®), incl. factory-fitted Push-to-Open valve, overflow and water inlet, Champagne	491		
<input type="checkbox"/>	UBQ 177 FIN 7A2BCV3 XX	Finion, freestanding, seamless, Colour on Demand (Quaryl®), incl. factory-fitted Push-to-Open valve and overflow, Emotion feature, Champagne	491		
<input type="checkbox"/>	UBQ 177 FIN 7N2BCV3 XX	Finion, freestanding, seamless, Colour on Demand (Quaryl®), incl. factory-fitted Push-to-Open valve, overflow and water inlet, Emotion feature, Champagne	491		
<input type="checkbox"/>	UBQ 177 FIN 7A3BCV2 XX	Finion, freestanding, seamless, Colour on Demand (Quaryl®), incl. factory-fitted Push-to-Open valve and overflow, design ring, Gold	492		
<input type="checkbox"/>	UBQ 177 FIN 7N3BCV2 XX	Finion, freestanding, seamless, Colour on Demand (Quaryl®), incl. factory-fitted Push-to-Open valve, overflow and water inlet, design ring, Gold	492		

BATHS



ORDER FORM FOR BATHS WITH COLOUR ON DEMAND

€ excl. VAT

Article number	Description	Page	01	RW
<input type="checkbox"/> UBQ 177 FIN 7A3BCV1 XX	Finion, freestanding, seamless, Colour on Demand (Quaryl®), incl. factory-fitted Push-to-Open valve and overflow, design ring and Emotion feature, Gold	492		
<input type="checkbox"/> UBQ 177 FIN 7N3BCV1 XX	Finion, freestanding, seamless, Colour on Demand (Quaryl®), incl. factory-fitted Push-to-Open valve, overflow and water inlet, design ring and Emotion feature, Gold	492		
<input type="checkbox"/> UBQ 177 FIN 7A3BCV4 XX	Finion, freestanding, seamless, Colour on Demand (Quaryl®), incl. factory-fitted Push-to-Open valve and overflow, Gold	492		
<input type="checkbox"/> UBQ 177 FIN 7N3BCV4 XX	Finion, freestanding, seamless, Colour on Demand (Quaryl®), incl. factory-fitted Push-to-Open valve, overflow and water inlet, Gold	492		
<input type="checkbox"/> UBQ 177 FIN 7A3BCV3 XX	Finion, freestanding, seamless, Colour on Demand (Quaryl®), incl. factory-fitted Push-to-Open valve and overflow, Emotion feature, Gold	492		
<input type="checkbox"/> UBQ 177 FIN 7N3BCV3 XX	Finion, freestanding, seamless, Colour on Demand (Quaryl®), incl. factory-fitted Push-to-Open valve, overflow and water inlet, Emotion feature, Gold	492		
<input type="checkbox"/> UBQ 180 LAB 2PDBCX-XX	La Belle, freestanding, incl. panel in Colour on Demand (Quaryl®), incl. waste/overflow chrome-plated	496		
<input type="checkbox"/> UBQ 180 LAB 9W1BCV-XX	La Belle, freestanding, seamless, Colour on Demand (Quaryl®), incl. waste/overflow chrome-plated, Excellence	498		
<input type="checkbox"/> UBQ 180 LAB 9T1BCV-XX	La Belle, freestanding, seamless, Colour on Demand (Quaryl®), incl. pre-fitted Multiplex Trio (chrome plated), Excellence	498		
<input type="checkbox"/> UBA 180 LFO 7PDBCX-XX	Loop & Friends, Duo, freestanding, incl. panel in Colour on Demand (Acrylic), incl. waste/overflow chrome-plated, With oval outer and inner form	524		
<input type="checkbox"/> UBA 180 LFS 7PDBCX-XX	Loop & Friends, Duo, freestanding, incl. panel in Colour on Demand (Acrylic), incl. waste/overflow chrome-plated, with square outer and inner form	513		
<input type="checkbox"/> UBQ 180 SQE 7PDBCX-XX	Squaro Edge 12, freestanding, incl. panel in Colour on Demand (Quaryl®)	557		
<input type="checkbox"/> UBQ 180 OBR 9CDBCX-XX	Oberon 2.0, wall-facing, incl. panel in Colour on Demand (Quaryl®)	540		
<input type="checkbox"/> UBQ 180 SQE 9W2BCV-XX	Squaro Edge 12, seamless, Colour on Demand (Quaryl®), incl. pre-fitted outlet and overflow (chrome plated), Excellence	559		
<input type="checkbox"/> UBQ 180 SQE 9T2BCV-XX	Squaro Edge 12, seamless, Colour on Demand (Quaryl®), including pre-fitted water inlet (chrome-plated), Excellence	559		
<input type="checkbox"/> UBQ 155 ANH 7F2BCV-XX	Theano, freestanding, Colour on Demand (Quaryl®)	574		
<input type="checkbox"/> UBQ 175 ANH 7F2BCV-XX	Theano, freestanding, Colour on Demand (Quaryl®)	576		

Inside colour of bath: (Replace XX with colour code)

White Alpin (01)

RW (Stone White)

Step 2: Colour On Demand colour selection:

Choose your favorite bath panelling (please tick):

Artis Colours to match washbasins

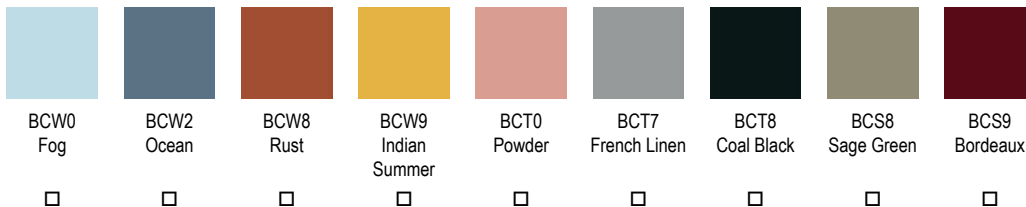

Note: Artis colours are only available with a satin-finish gloss.

Please be aware that the Finion furniture colours are not identical to the Artis colours. However, the colours are harmoniously matched.

Individual color selection: (Please enter colour code at the corresponding System)

RAL

Sikkens

Pantone

Finish: Choose your favorite finish (please tick) - Not for Artis colours!

Note: metallic colours and colours with RAL pearl finish are not feasible

Glossy

Matt

Satin

Due to the different materials used, there may be variations in colour between the images and the actual products.

Send off

Retail trade: Fill in this form as completely as possible and send it to your wholesaler. Remember to retain a copy. Clearly indicate your order number.
Villeroy & Boch AG, Unternehmensbereich Bad und Wellness, Postfach 12 30, 66693 Mettlach, Deutschland. Tel. +49 (0)6864/810

ACCESSORIES FOR BATHS

€ excl. VAT

TouchLight

The new lighting set for the bath:

- TouchLight is the first bath lighting from Villeroy & Boch for Quarry® and Acrylic baths without a whirlpool system.
- Bath lighting creates a relaxing atmosphere in the bathroom.
- Works whether or not the bath is full.
- 1 touch-LED completely preinstalled for easy operation – this means that no controls are required on the rim of the bath.
- Operated by touching the LED light
- TouchLight is available in the variant 1 LED spot colored (6 colors: blue, violet, red, orange, yellow, green and toggle mode).
- The surface of the visible component is chrome-plated.
- Not suitable for whirlpool systems.
- For all Quarry® and Acrylic baths from Villeroy & Boch except: Aveo New Generation, Hommage, La Belle free-standing
- KEMA certification mark.
- In accordance with European EMC and CE guidelines
- Voltage: 230V/50 Hz



ACCESSORIES FOR BATHS

Position TouchLight in our baths:

- Rectangular baths with one back position (solo): in the left side wall.
- Rectangular baths two back positions (duo): in the side wall below the overflow hole.
- Corner baths and offset corner baths: in the front side wall („step-in side“) below the overflow hole.

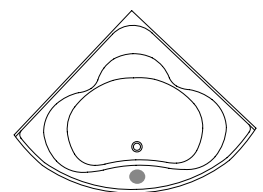
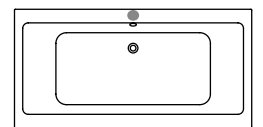
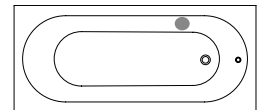

Description	Price
TouchLight, 1 LED spotlight, coloured (6 colours and alternating colour programme), preassembled, not possible in combination with a whirlpool	

ACCESSORIES FOR BATHS

€ excl. VAT

UNITED bath panelling

- High-quality, simple bath panelling with aluminium frame for selected Quaryl® baths.
- UNITED is suitable for both free-standing and corner installation.
- Melamine-coated panel surfaces available in:
 - Oak Graphite (FQ)
 - Glossy White (DH)
- UNITED is intended for installation on the finished floor.
- Shadow gap panels, black
- The UNITED bath panelling is pre-assembled for all matching baths.



PROFIBOX, bath panelling for rectangular acrylic and Quaryl® baths

- Profibox increases the range of possibilities for installing baths and whirlpool systems.
- PROFIBOX is suitable for both corner assembly and for assembly in a niche.
- Profibox is possible for the following baths:
 - Architectura
 - Collaro
 - Legato
 - Oberon
 - Oberon 2.0
 - O.novo
 - Squaro Edge 12
 - Subway 3.0
 - other models available on request (for all rectangular models apart from models with a length of 2000 mm).
 - Profibox is available in colours White Alpine (01).
 - The PROFIBOX bath panelling is pre-assembled for all matching baths.
 - Note: The Profibox cannot be retro-fitted.



ACCESSORIES FOR BATHS

€ excl. VAT

Multifunction cushion

- Material: high-quality, soft foam
- waterproof
- Dimensions: 240 x 150 x 50 mm, fits all Villeroy & Boch baths
- Can also be used as cushion or foot stopper
- Available in the colours:



Bali (LK)



Peru (LL)



Anthracite (PA)

Article number	Description	Price
U906100LK	Multifunction cushion, foam, 240 x 150 x 50 mm, Bali	
U906100LL	Multifunction cushion, foam, 240 x 150 x 50 mm, Peru	
U906100PA	Multifunction cushion, foam, 240 x 150 x 50 mm, Anthracite	

Handgrips

- Suitable for acrylic and Quaryl® bathtubs
- Material: brass
- Available in colour:



chrome-plated (61)

Article number	Description	Price
U90170061	Handgrips, 1 pair = 2 grips, chrome	

ACCESSORIES FOR BATHS

€ excl. VAT

ViFlow

The clever bath outlet and overflow

How ViFlow works

Open bath valve

The valve is opened by pushing down on the valve cover and turning it. The water flows through the valve into the waste water pipe.

Closed bath valve

Turn the valve to close it. The bath fills with water. The integrated overflow function continuously monitors the water level in the bath.

Overflow function

Once the water level reaches the overflow limit, the valve opens automatically and the water flows into the waste water pipe, preventing the bath from overflowing.

The advantages of ViFlow

- Valve is closed by pulling the valve cover up
- Integrated, mechanical, invisible overflow function
- Drain can be easily accessed for cleaning by removing outlet cover (with tools supplied)

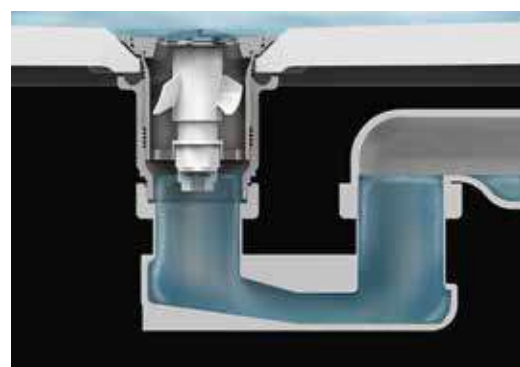
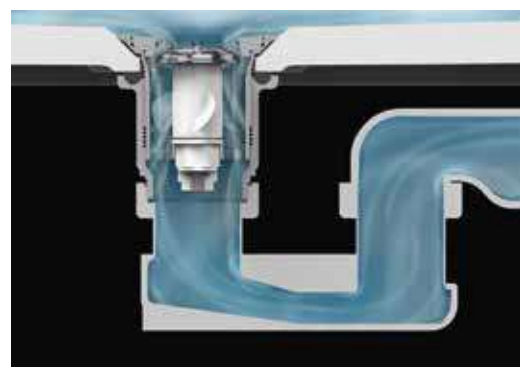

ViFlow is also available for baths from the **Antheus** and **Theano** collections.

Article number	Description	Price
U90953061	ViFlow, Outlet and overflow fittings without an overflow, chrome	
U90953068	ViFlow, Outlet and overflow fittings without an overflow, White	
U909530RW	ViFlow, Outlet and overflow fittings without an overflow, Stone White	
U90953033	ViFlow, Outlet and overflow fittings without an overflow, Black Matt	



ACCESSORIES FOR BATHS

€ excl. VAT

ViFlow

Technical details on the installation

Maximum filling rate 30 l/min

ANTHEUS

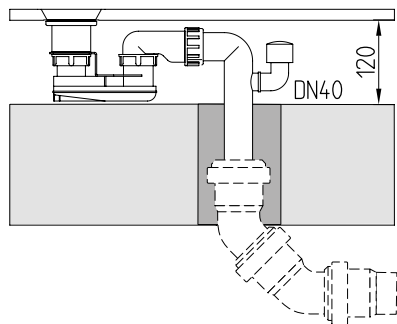

THEANO

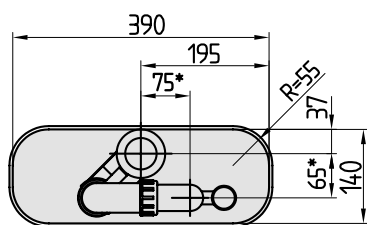
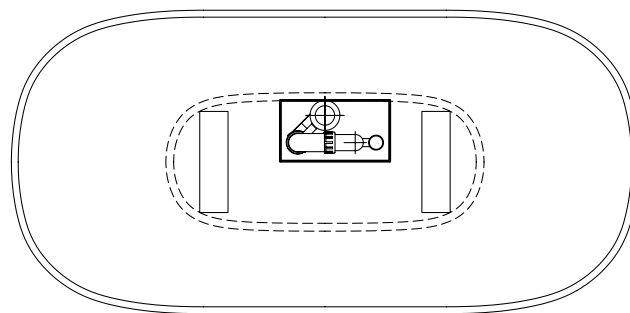
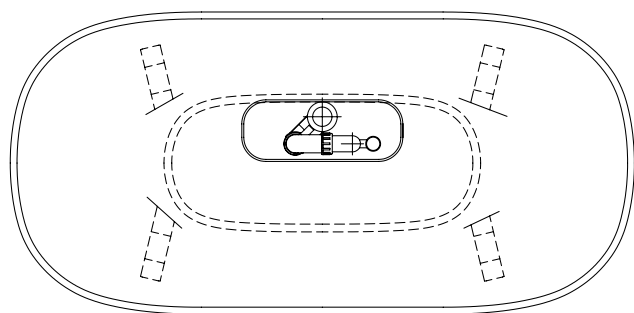
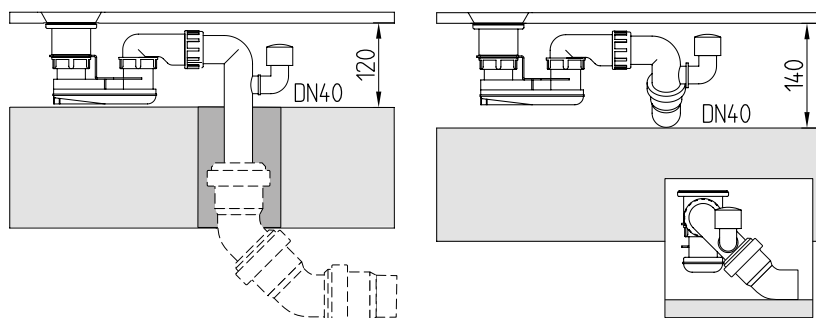

Top view

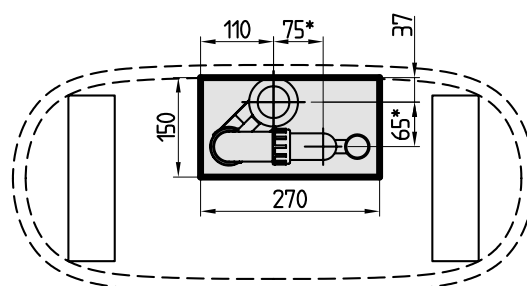

Top view

□ Maximum free space for outlet

* Connection waste pipe (DN40) in the flXoor

ACCESSORIES FOR BATHS

WHIRLPOOL SYSTEMS - EQUIPMENT

€ excl. VAT

Overview of whirlpool equipment

	Airpool Entry	Airpool Comfort	Hydropool Entry	Hydropool Comfort	Combipool Entry	Combipool Comfort	Special Combipool Invisible	Special Combipool Active
	AE	AC	HE	HC	CE	CC	IP	AP
Base jets								
Micro base jets	10	-	-	-	10	-	-	-
Large Whisper base jets	-	10	-	-	-	10	-	-
Large Fitness jets	-	-	-	-	-	-	12	-
Air-Royale-jets	-	-	-	-	-	-	-	24
Back jets								
Micro back jets	-	-	8	8	8	8	-	-
Active back jets	-	-	-	-	-	-	-	6
Side jets								
Whisper Side Jets	-	-	-	8	-	8	-	-
Whisper Active side jets	-	-	-	-	-	-	-	8
Pop-up side jets	-	-	-	-	-	-	16	-
Foot jets								
Micro foot jets	-	-	-	2	-	2	-	-
Active foot jets	-	-	-	-	-	-	-	2
Functions								
Intervals	1	1	1	1	1	1	3	1
Programmes	-	2	-	2	-	2	-	6
2 white LEDs	○	-	○	-	○	-	-	-
2 multi-coloured LEDs (magic light)	-	○	-	○	-	○	○	○
Rim control	○	○	○	○	○	○	-	-
Smart Control	-	-	-	-	-	-	○	○
Pre-fitted outlet	○	○	○	○	○	○	○	○
Blow dry feature	○	○	-	-	○	○	○	○
Electrical installation								
Voltage	230V, 50Hz							
Power	0,9 kW	0,03 kW	0,7 kW	0,9 kW	1,6 kW	0,93 kW	2,4 kW	0,93 kW

Note: The numbers in the table indicate the number of jets / functions. The "O" symbol means that the system is fitted with the specified function.







WHIRLPOOL SYSTEMS - EQUIPMENT

€ excl. VAT

Whirlpool systems from Villeroy & Boch offer the following advantages:









- Nearly all the main components were developed by Villeroy & Boch specifically for the whirlpool systems.
- All our systems are especially quiet.
- The whirlpools have an impressively low power consumption and chemical-free cleaning technology for low environmental impact.
- Every pool is easily adjustable thanks to a stable frame with four legs.
- Our whirlpool jets offer the ideal combination of comfort, optimum massage pressure and low volume.
- The visible parts are quick and easy to replace e.g. for cleaning
- The jets have a separate water and air supply to ensure optimum performance.

AIRPOOL ENTRY (AE)

Pool	Jets	Functions
 <p>Invigorating bathing pleasure</p> 	<p style="text-align: center;">10 Micro base jets</p> <div style="display: flex; justify-content: space-around;"> <div style="text-align: center;"> <p>Acrylic</p>  </div> <div style="text-align: center;"> <p>Quaryl®</p>  </div> </div> <ul style="list-style-type: none"> • 10 base jets ensure a stimulating massage with gentle air bubbles • Perfect comfort: optimum jet design offers ideal comfort in either a seated or lying position 	<p>Control:</p>  <p>Rim control</p> <p>Intervals</p>  <p>1 Interval</p> <p>Light:</p>  <p>2 white LEDs</p>

WHIRLPOOL SYSTEMS







AIRPOOL COMFORT (AC)

Pool	Jets	Functions
 <p>Like the tingle of champagne, as quiet as a whisper</p> 	<div style="display: flex; justify-content: space-around;"> <div style="text-align: center;"> <p>10 large Whisper base jets</p> <p>Acrylic</p>  </div> <div style="text-align: center;">  <p>Quaryl®</p>  </div> </div> <p>Silent relaxation: With a low operating volume in accordance with DIN 4109 / SIA181 (<25 dBa für UGh) and tested at the Fraunhofer Institut, the whisper system is one of the quietest on the market. Suitable for use in multi-storey residential construction.</p> <ul style="list-style-type: none"> • 10 base jets ensure a stimulating massage with gentle air bubbles • Perfect comfort: optimum jet design offers ideal comfort in either a seated or lying position • In Quaryl baths: base jets are integrated flush • Perfect aesthetics and really easy to clean 	<p>Control:</p>  <p>Rim control</p> <p>Intervals</p>  <p>1 Interval 2 Programs (Flow and Energy)</p> <p>Light:</p>  <p>2 multi-coloured LEDs (magic light)</p>

WHIRLPOOL SYSTEMS - EQUIPMENT











€ excl. VAT

HYDROPOOL ENTRY (HE)

Pool	Jets	Functions
 <p>Wellness for your back</p> 	<p>8 Micro back jets</p> <p>Acrylic Quaryl®</p>   <ul style="list-style-type: none"> Thanks to their optimum arrangement, 8 micro back jets ensure a powerful, uniform massage 	<p>Control:</p>  <p>Rim control</p> <p>Intervals</p>  <p>1 Interval</p> <p>Light:</p>  <p>2 white LEDs</p>

WHIRLPOOL SYSTEMS







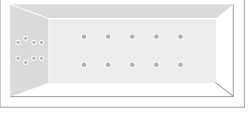

HYDROPOOL COMFORT (HC)

Pool	Jets	Functions
 <p>Pampering from head to toe</p> 	<p>8 Whisper side jets</p>  <p>Acrylic Quaryl®</p>   <p>Silent relaxation: With a low operating volume in accordance with DIN 4109 / SIA181 (<25 dBA für UGh). Tested at the Fraunhofer Institut, the whisper system is one of the quietest on the market. Suitable for use in multi-storey residential construction.</p> <ul style="list-style-type: none"> The side jets are manually adjustable and closable and can be rotated by almost 270° <hr/> <p>8 Micro back jets 2 Micro foot jets</p> <p>Acrylic Quaryl®</p>   <ul style="list-style-type: none"> Thanks to their optimum arrangement, 8 micro back jets ensure a powerful, uniform massage 2 foot jets for a beneficial foot massage 	<p>Control:</p>  <p>Rim control</p> <p>Intervals</p>  <p>1 Interval 2 Programs (Flow and Energy)</p> <p>Light:</p>  <p>2 multi-coloured LEDs (magic light)</p>

WHIRLPOOL SYSTEMS - EQUIPMENT

€ excl. VAT

COMBIPOOL ENTRY (CE)











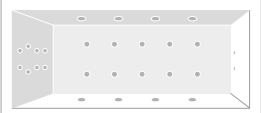

Pool	Jets	Functions
 <p>Enjoyable moments in one's own bathroom</p> 	<p style="text-align: center;">8 Micro back jets</p> <div style="display: flex; justify-content: space-around;"> <div style="text-align: center;"> <p>Acrylic</p>  </div> <div style="text-align: center;"> <p>Quaryl®</p>  </div> </div> <ul style="list-style-type: none"> Thanks to their optimum arrangement, 8 micro back jets ensure a powerful, uniform massage <hr/> <p style="text-align: center;">10 Micro base jets</p> <div style="display: flex; justify-content: space-around;"> <div style="text-align: center;"> <p>Acrylic</p>  </div> <div style="text-align: center;"> <p>Quaryl®</p>  </div> </div> <ul style="list-style-type: none"> 10 base jets ensure a stimulating massage with gentle air bubbles Perfect comfort: optimum jet design offers ideal comfort in either a seated or lying position 	<p>Control:</p>  <p>Rim control</p> <p>Intervals</p>  <p>1 Interval</p> <p>Light:</p>  <p>2 white LEDs</p>

WHIRLPOOL SYSTEMS

WHIRLPOOL SYSTEMS - EQUIPMENT

€ excl. VAT

COMBIPOOL COMFORT (CC)







Pool	Jets	Functions
 <p>As quiet as a whisper, strong and relaxing</p> 	<div data-bbox="560 286 1034 790"> <p>8 Whisper side jets </p> <p>Acrylic Quarry®</p>   <p>Silent relaxation: With a low operating volume in accordance with DIN 4109 / SIA181 (<25 dBa für UGh). Tested at the Fraunhofer Institut, the whisper system is one of the quietest on the market. Suitable for use in multi-storey residential construction.</p> <ul style="list-style-type: none"> • Thanks to their stimulating effect, these jets are ideal for easing muscular tension and offer relaxation after a noisy and hectic day at work. • The side jets are manually adjustable and closable and can be rotated by almost 270° </div> <div data-bbox="560 790 1034 1126"> <p>8 Micro back jets 2 Micro foot jets</p> <p>Acrylic Quarry®</p>   <ul style="list-style-type: none"> • Thanks to their optimum arrangement, 8 micro back jets ensure a powerful, uniform massage • 2 foot jets for a beneficial foot massage </div> <div data-bbox="560 1126 1034 1406"> <p>10 large Whisper base jets </p> <p>Acrylic Quarry®</p>   <ul style="list-style-type: none"> • Ensure a stimulating massage with gentle air bubbles </div>	<p>Control:</p>  <p>Rim control</p> <p>Intervals</p>  <p>1 Interval 2 Programs (Flow and Energy)</p> <p>Light:</p>  <p>2 multi-coloured LEDs (magic light)</p>

WHIRLPOOL SYSTEMS

WHIRLPOOL SYSTEMS - EQUIPMENT

€ excl. VAT

SPECIAL COMBIPOOL INVISIBLE (IP)









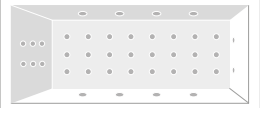

Pool	Jets	Functions
 <p>Your personal pampering programme</p> 	<p>16 pop-up side jets</p> <p>Acrylic Quaryl®</p>    <ul style="list-style-type: none"> • 16 pop-up side jets for perfect comfort • Pop-up side jets are only activated when the system is started • Perfect aesthetics and really easy to clean • In acrylic and Quaryl baths, integrated as invisible jets as standard, in Quaryl baths, integrated absolutely flush <hr/> <p>12 large Fitness jets</p> <p>Acrylic Quaryl®</p>   <ul style="list-style-type: none"> • Optimum massage: 12 large base jets for a bubbling, individual feel-good experience • Intensity is infinitely adjustable • In acrylic and Quaryl baths, integrated as invisible jets as standard, in Quaryl baths, integrated absolutely flush 	<p>Control:</p>  <p>Smart Control</p> <p>Intervals</p>  <p>3 intervals</p> <p>Light:</p>  <p>2 multi-coloured LEDs (magic light)</p>

WHIRLPOOL SYSTEMS

WHIRLPOOL SYSTEMS - EQUIPMENT

€ excl. VAT







SPECIAL COMBIPOOL ACTIVE (AP)

Pool	Jets	Functions
 <p>For a deep massage as if given by hand</p> 	<div style="border-bottom: 1px solid black; padding-bottom: 10px;"> <p style="text-align: center;">8 Whisper Active side jets</p> <div style="display: flex; justify-content: space-around;"> <div style="text-align: center;"> <p>Acrylic</p>  </div> <div style="text-align: center;"> <p>Quaryl®</p>  </div> </div> <p>The special, motor-controlled, closable side jets can be rotated by almost 360° and offer a realistic and effective professional-style massage</p> </div> <div style="border-bottom: 1px solid black; padding-bottom: 10px;"> <p style="text-align: center;">6 Active back jets 2 Active foot jets</p> <div style="display: flex; justify-content: space-around;"> <div style="text-align: center;"> <p>Acrylic</p>  </div> <div style="text-align: center;"> <p>Quaryl®</p>  </div> </div> <p>The special, motor-controlled, closable back and foot jets can be rotated by almost 360° and offer a realistic and effective professional-style massage</p> </div> <div> <p style="text-align: center;">24 Air-Royale jets</p> <div style="display: flex; justify-content: space-around;"> <div style="text-align: center;"> <p>Acrylic</p>  </div> <div style="text-align: center;"> <p>Quaryl®</p>  </div> </div> <p>Densely distributed to optimum effect over the entire base of the bath for a more complete massage</p> </div>	<p>Control:</p>  <p>Smart Control</p> <p>Intervals</p>  <p>1 Interval 6 programmes Flow: gentle massage Energy: intensive massage Fit programme: vitalising massage Relief: Back- foot massage Intense: Intensive back massage Joy: Active side massage</p> <p>Light:</p>  <p>2 multi-coloured LEDs (magic light)</p>

WHIRLPOOL SYSTEMS

WHIRLPOOL SYSTEMS - VISIBLE PARTS

€ excl. VAT

	Standard	Option	
all systems	 chrome-plated (61)	 Gold-plated (62)	On request
	Only for the Special CombiPool Invisible (IP):		
	 White (01), Stone White (RW) (Invisible Jets)*	 chrome-plated (61)	without surcharge
		 Gold-plated (62)	On request
Note: Jets are not available in Champagne and Black Matt			
Separate options	 chrome-plated (61)	 Gold-plated (62)	On request

* same colour as the bath

Visible parts whirlpool systems:	
Standard equipment	Separate options
Jets	Air grating
Rim control	Viega Multiplex Trio
Drain/overflow combination	

WHIRLPOOL SYSTEMS - EXPLANATION EQUIPMENT

€ excl. VAT

Whisper Technology

Whirlpool systems with Whisper technology satisfy the noise level requirements in accordance with DIN 4109 – as tested at the Fraunhofer Institut – making them among the quietest systems on the market. The extremely quiet Whisper jets encourage calm and relaxation for the perfect all-round feel-good atmosphere. In the Quarryl® models, the nozzles are flush-mounted, ensuring a discreet appearance and perfect aesthetics. The Airpool Comfort, Hydropool Comfort and Combipool Comfort whirlpool systems are all equipped with Whisper nozzles.

Whisper Base Jets



Whisper Side Jets

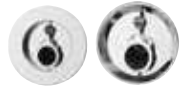

Acrylic



Quarryl®



Whisper Active Jets

These unique jets guarantee a more intense and targeted massage. The three Flow, Energy and Fit programmes were developed in collaboration with the sports medicine specialist, Prof. Dr. Allmann: they offer sheer relaxation and promote your emotional well-being and physical health in the long term. Relieve aching muscles and tension and stimulate the circulation at the push of a button. In addition, the Whisper Active Jets can also be individually controlled. The Active Pool is equipped with these jets.



Air Royale

The 24 jets are densely distributed to optimum effect over the entire base of the bath so that thousands of tiny air bubbles create a bubbling champagne effect on contact points over the whole body – producing a pleasant, relaxing effect on the skin. The Special Combipool Active is equipped with Air Royale jets.



6 back- and 2 foot jets

Equipment: 6 back jets, 2 foot jets
Aesthetic appearance: with jets that are fitted flush in the bath (for Quarryl baths)
Effective massage: thanks to a variety of direction and intensity settings

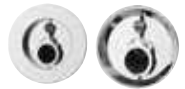

Active Jets

Back and foot jets with electronic control.
3 new, additional programmes promote relaxation and alleviate pain in the back and neck area:

- RELIEF: beneficial back and foot massage to relax the muscles
- INTENSE: powerful, intensive and localised back massage
- JOY: vitalising massage thanks to the back and foot jets

Targeted and intensive massage

- Adjustable direction of the water jet for a varying and intensive full-body massage
- Various programmes available to select the massage intensity

The Special Combipool Active is equipped with Active Jets.



Programmes

All six available programmes were developed in collaboration with the sports medicine specialist, Prof. Dr. Allmann: They offer sheer relaxation and promote your emotional well-being and physical health in the long term. Relieve aching muscles and tension and stimulate the circulation at the push of a button.

- Flow: Gentle massage
- Energy: Intensive massage
- Fit programme: Revitalising massage
- Relief: Back and foot massage
- Intense: Intensive back massage
- Joy: Active side massage

The Flow and Energy programmes are offered for the three Comfort models (AC, HC, CC) all six programmes for the Special Combipool Active (AP).



Smart Control

The Smart Control remote control for the Special Combipools Active and Invisible features an impressively aesthetic design and maximum comfort. The self-explanatory menu guidance provides access to a personal feel-good programme at the push of a button. In this way, all previous and new options can be controlled quickly and easily. Thanks to the use of Soft Touch materials, this small technical miracle also gains a secure hold on wet surfaces.



WHIRLPOOL SYSTEMS

WHIRLPOOL SYSTEMS - EXPLANATION EQUIPMENT

€ excl. VAT

Underwater lighting (two white LED spotlights)

The underwater lighting creates a luxurious atmosphere in the bathroom with two white LED spotlights. The design of the LED lights is very flat, giving them a neat, attractive and comfortable look.



Magic Light

The sheer joy of colour. Colour therapy is a holistic form of therapy that uses light and colours for the well-being of mind, body and spirit. The LED lights have a very flat design that is attractive, clean and comfortable. The colours can be adjusted individually and add the finishing touch to the relaxing experience in a whirlpool system from Villeroy & Boch.



Viega Multiplex Trio

The Trio combines three functions: inlet, waste and overflow. This attractively designed all-rounder can be fitted into all Villeroy & Boch whirlpools and is produced in the same colour as the visible parts.



Separate pipe interrupter for Smart Filling/Viega Multiplex Trio

The visible part of the pipe is the same colour as the other visible parts of the system.



Air grating

For optimum ventilation and cooling, dimensions 198 x 148 mm.



UNITED bath panelling

High-quality, simple bath panelling with aluminium frame for selected Quarryl® baths.



Profibox

Profibox increases the range of possibilities for installing baths and whirlpool systems.



WHIRLPOOL SYSTEMS

PRE-DRILLED HOLES ORDER FORM

How to use this form?

- A** Please give us all the information we need concerning your contract: article data of the bath (UBA... or UBQ...), your order data, etc.
- B** Draw a sketch of the bath you want. Mark the position of the outlet and overflow, and the positions for the tap holes. Important: Please specify from which corner the measurements were made. Mark this position with the letter „H“.
- C** Note the diameter for each hole, the centred distance between the holes (H1, H2 etc.) and the distance from the outer edge of the bath rim (H0) to the centre of the first hole (L1).

Date: _____

Retailer: _____

A Article nr. bathtub: _____

Your order number: _____

B

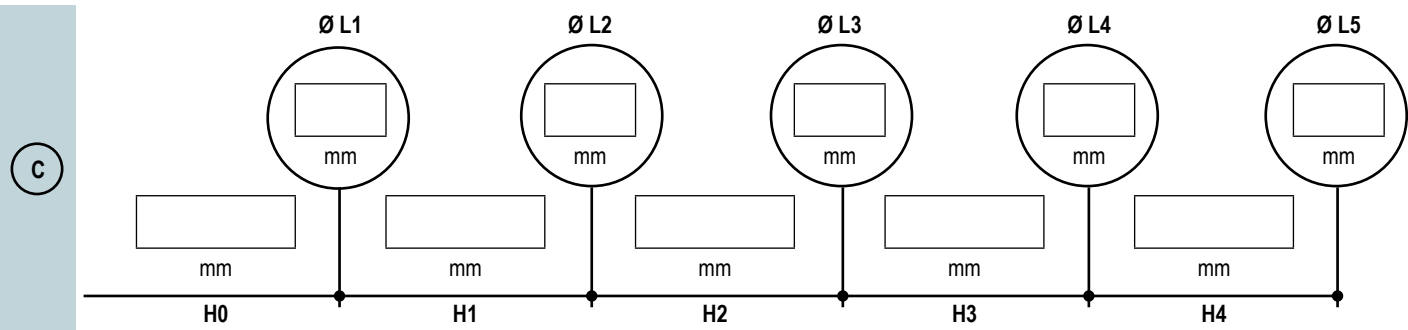
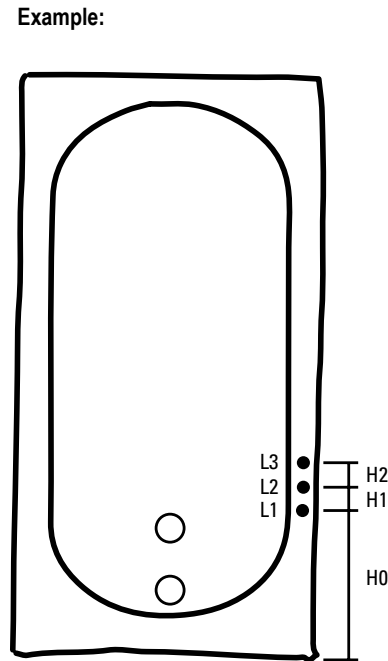

Comments:

PRE-DRILLED HOLES ORDER FORM

Checklist for preparing to install whirlpool systems

Dear Customer, thank you for your interest in our product. The whirlpool system is delivered completely pre-assembled. In order to ensure the correct and safe installation of your whirlpool system, please note the following points:

1. Connection to power supply

- | | |
|--|--|
| <input type="checkbox"/> Connection to power supply | Power supply with 230 V/50 Hz |
| <input type="checkbox"/> Fuse | Fuse max. 16 A.
Residual-current devices (RCDs) with max. 30 mA rated release current |
| <input type="checkbox"/> Potential equalisation line | The system has to be connected to the potential equalisation in the bathroom in accordance with the applicable local rules. |
| <input type="checkbox"/> Mains isolator | The connector should be fitted with an all-pole mains switch, which is installed below the bath near the control box. When switched off, this switch should have a contact gap of at least 3 mm and meet safety requirements IPX5. |
| <input type="checkbox"/> Connection | The whirlpool system meets the requirements for devices in protection class I and is to be permanently connected to a distribution box via fixed cabling of at least 3 x 2.5 mm ² . |
| <input type="checkbox"/> Caution | The installation of the electrical equipment and any necessary repairs may only be performed by a qualified electrical engineer. The applicable local regulations must be observed for the electrical installation. |

2. Outlet / water connection

- | | |
|---|--|
| <input type="checkbox"/> Outlet | The waste pipe should have a diameter of 40 - 50 mm and be prefitted near the installation site. |
| <input type="checkbox"/> Water connection | Please note the position of the taps. If the whirlpool system is fitted with a Multiplex Trio inlet fitting, the applicable national regulations for the water installation must be observed. A pipe interrupter is also required. |

3. Installation

- | | |
|--|--|
| <input type="checkbox"/> Accessibility | The technical parts of the whirlpool system must be accessible. To this end, a cover that can be dismantled is required. It should only be possible to remove this cover using tools.
The position of the mains connection and of the other technical parts depends on the type of whirlpool selected and the bath model (see product pages). |
| <input type="checkbox"/> Ventilation | There has to be a ventilation grate or a ventilation opening free cross-section min. 40 cm ² . |
| <input type="checkbox"/> Installation | Please note that the installation height of a whirlpool is often greater than for a normal bath.
We recommend installing the whirlpool system against the tiled wall and on the tiled floor. Please take note of the work plan in order to prevent damage to the whirlpool system. |

4. Responsibilities of the customer

- | | |
|---|--|
| <input type="checkbox"/> Condition of the floor | Ensure that the condition of the floor is suitable to hold the weight of the whirlpool system and that the floor is resistant to moisture. |
| <input type="checkbox"/> Transport | Please check the route for transporting the whirlpool system into the bathroom for obstacles (stairs, doors) and check that there is sufficient room for manoeuvre, etc. |
| <input type="checkbox"/> Ventilation | The bathroom should have adequate ventilation (with the help of mechanical ventilation). |
| <input type="checkbox"/> Noise reduction | In order to prevent sound bridges, please take note of the following: <ul style="list-style-type: none">• Direct contact with the building itself must be avoided, for example, with sufficiently large silicon joints or by using special soundproofing strips.• The installation site should be solid and low-vibration.• Any contact between the support structure and bath and/or system components must be avoided.• Tap fittings that are mounted directly onto the rim of the bath should be connected with flexible hoses.• Airborne sound is reduced by using insulating material (inside the wall and ceiling cavity) and by avoiding superfluous air outlets (below the whirlpool). |

Order form whirlpool systems

Wholesaler order number: _____

Company name: _____

Contact person: _____

Postal code and town/city: _____

Address: _____

Fax: _____

Tel. no.: _____

Signature: _____

Configure the whirlpool you require

Step 1: The bath

Combined article number / name of the bath incl. colour and technology item
(Example: U AE 180 OBE 2A1 V01 / Airpool Entry Oberon 180, technology item 1, white)

- Visible parts:**
- Chrome-plated (standard) White (alpin) (01)
(Only jets), only possible for Special System CombiPool Invisible
- Gold-plated (on demand)

Step 2: Accessories:

	Optional extras (please tick as required)		Price
TI00	Separate pipe interrupter for Viega Multiplex Trio/Water inlet	<input type="checkbox"/>	
AG00	Air grating	<input type="checkbox"/>	
TH0_	Drilling holes (_ indicate the number of holes), price per piece. Please use the form.	<input type="checkbox"/>	

Step 3: Further options (For combination possibilities with the chosen bath, see the corresponding bath model):

	Description	Colour code	LK	LL	PA	61	Price
HRXX	Multifunction cushion		<input type="checkbox"/>	<input type="checkbox"/>	<input type="checkbox"/>		
HGXX	Preassembled handles (depending on model)					<input type="checkbox"/>	

Replace XX with colour code LK = Bali LL = Peru PA= Anthracite 61=Chrome

Step 4: Model depending panels (For combination possibilities with the chosen bath, see the corresponding bath model):

	Description	Colour code		DH	FQ	Price
PO01	Panel (corner, offset)		<input type="checkbox"/>			
PS01	Panel Squaro corner same color as bath		<input type="checkbox"/>			
UCXX	UNITED Corner			<input type="checkbox"/>	<input type="checkbox"/>	
PC01	Profibox Corner		<input type="checkbox"/>			
PA01	Profibox Alcove		<input type="checkbox"/>			

Replace XX with colour code DH = Glossy White FQ = Oak Graphite 01 = White Alpin

For the order form for baths incl. preassembled options, please fold out page



Send off

Retail trade: Fill in this form as completely as possible and send it to your wholesaler. Remember to retain a copy. Clearly indicate your order number.
Villeroy & Boch AG, Unternehmensbereich Bad und Wellness, Postfach 12 30, 66693 Mettlach, Deutschland. Tel. +49 (0)6864/810

Order form for baths incl. preassembled options

Wholesaler order number:

Company name:

Contact person:

Postal code and town/city:

Address:

Fax:

Tel. no.:

Signature:

Follow these 3 steps:

Step 1: The bath: Choose your favourite Villeroy & Boch bath (and, if desired, the matching bath options)

Article number / Bath name:

Colour/colour no.:

White Alpin (01) Stone White (RW)

Step 2: Accessoires: Choose your favorite preassembled bath accessoires (please tick as required):

Preassembled bath accessoires (please tick as required):

	Description		Price
TL20	TouchLight, 1 LED spotlight, coloured	<input type="checkbox"/>	
TH0_	Drilling holes (_ indicate the number of holes), price per piece. Please use the form.	<input type="checkbox"/>	

Step 3: Bath panning (depending on model): Choose your favorite bath panning (please tick as required):

Model depending panels (For combination possibilities with the chosen bath, see the corresponding bath model):

	Description	Colour code		DH	FQ	Price
PO01	Panel (corner, offset)		<input type="checkbox"/>			
PS01	Panel Squaro corner same color as bath		<input type="checkbox"/>			
UCXX	UNITED Corner			<input type="checkbox"/>	<input type="checkbox"/>	
UFXX	UNITED Free-standing			<input type="checkbox"/>	<input type="checkbox"/>	
PC01	Profibox – corner installation		<input type="checkbox"/>			
PA01	Profibox – alcove installation		<input type="checkbox"/>			

Replace XX with colour code DH = Glossy White FQ = Oak Graphite 01 = White Alpin

For corner or niche installation, please always specify the version. The desired position can be found on the corresponding page in the price list.

Possible positions:

Left:

4-3-1

1-2-4

Right:

3-1-2

2-4-3

Niche:

1-3

2-4

Further options (For combination possibilities with the chosen bath, see the corresponding bath model):

	Description	Colour code		LK	LL	PA	61	Price
HRXX	Multifunction cushion		<input type="checkbox"/>	<input type="checkbox"/>	<input type="checkbox"/>			
HGXX	Preassembled handles (depending on model)						<input type="checkbox"/>	
WO10	Waste/overflow combination	<input type="checkbox"/>						see bath page
WI00	Multiplex Trio	<input type="checkbox"/>						
WI10	Water inlet for Squaro Edge 12	<input type="checkbox"/>						
TI00	Separate pipe interrupter for Viega Multiplex Trio/Water inlet	<input type="checkbox"/>						

Replace XX with colour code LK = Bali, LL = Peru, PA = Anthracite, 61 = Chrome

Please note: in the order confirmation, "BA/BQ" from the article number will be replaced with the code "PB" (= preassembled bath).

← For the order form for whirlpool systems, please fold out page.

Send off

Retail trade: Fill in this form as completely as possible and send it to your wholesaler. Remember to retain a copy. Clearly indicate your order number.
Villeroy & Boch AG, Unternehmensbereich Bad und Wellness, Postfach 12 30, 66693 Mettlach, Deutschland. Tel. +49 (0)6864/810

Villeroy & Boch

Villeroy & Boch
Bad und Wellness
Postfach 12 30
66689 Mettlach
GERMANY
Tel. +49 (0) 68 64 / 81-0

WWW.VILLEROY-BOCH.COM